

# NORMALIT

by Normagrup



---

Technical  
and architectural lighting

[normalit.com](https://normalit.com)





Sense of technology  
[Normagrup DNA](#) 4

Normagrup Technology  
[Divisions](#) 5

International presence  
[From Spain to the world](#) 6

Manufacturing  
[From the raw material to the final product](#) 8

Environment  
[Committed to our planet](#) 9

Research and technology transfer  
[Normagrup LAB](#) 10

Special executions and customized projects  
[Normagrup 360](#) 12

Index  
[Normalit Catalogue](#) 14

---

**NORMALIT**

Technical and architectural lighting



[normalit.com](https://normalit.com)

Sense of technology

# Normagrup DNA

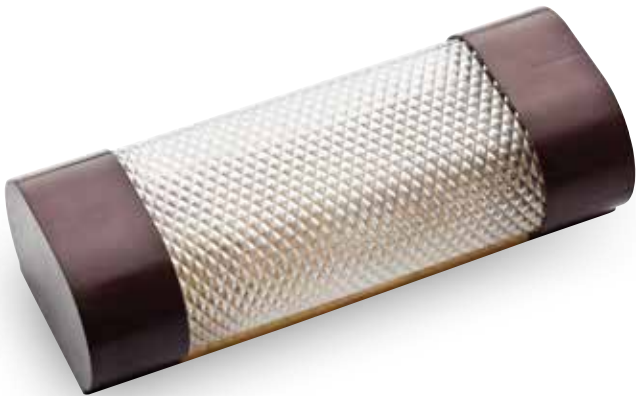

1971



GET TO KNOW  
NORMAGRUP

See video



Everything started with an emergency light. A little device that already contained the key to our DNA.

Guided by a sense of curiosity, we were discovering new needs and searching for the technology to meet them.

And so, new divisions were created, enabling us to integrate solutions and to handle large projects with total confidence.

Without skimping on resources or technology, without taking shortcuts, without saving in components or quality controls.

And with an ongoing desire to innovate and make the world better through technology.

Technology is our vehicle  
to make the world  
a better place.





Normagrup Technology

# Divisions

## NORMALUX

Emergency lighting  
[normalux.com](http://normalux.com)

Together, we make a perfectly coordinated team.

## NORMALIT

Technical and architectural lighting  
[normalit.com](http://normalit.com)

[www.normalux.com](http://www.normalux.com)

Leading company in the manufacture, sales and distribution of emergency lighting in Spain and worldwide. Our value has been proven by more than 40 years of experience, quality and confidence from our clients.

[www.normadet.com](http://www.normadet.com)

State of the art solutions for fire and toxic gas protection systems. Certified quality.

## NORMADET

Fire detection systems  
[normadet.com](http://normadet.com)

[www.normalit.com](http://www.normalit.com)

A division specialising in technical and architectural lighting which integrates all of the constructive process, incorporating the most innovative technology into products with a high technical quality.

[www.norclinic.com](http://www.norclinic.com)

Specialists in the manufacture of hospital equipment which integrates night lights, indirect lighting and medical gas outlets.

## NORCLINIC

Technical systems for hospitals  
[norclinic.com](http://norclinic.com)



International presence

# From Spain to the world

We distribute technology and innovation around the world from our facilities in Asturias and through various branches.

Our branches::

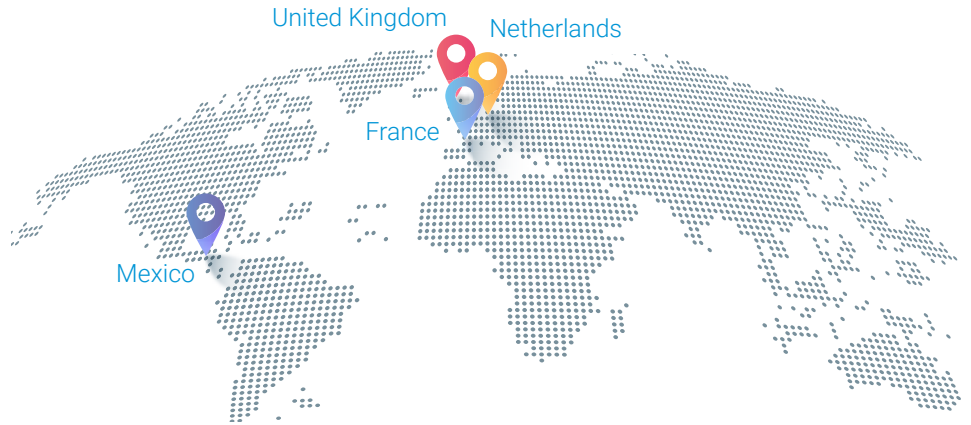

**100%**

*Entirely designed and manufactured in Spain*

30,000 sq.m.



4,500 sq.m.



1,200 sq.m.





6,000 sq.m.

# NTC

Normagrup Tech Center

## A space for research, testing and learning

Normagrup Tech Center is a 6,000 sq.m **building for laboratories and R&D**. It has been thought as NormaGrup's bet on innovation and technology. It also hosts an auditorium with capacity for 60 people where training sessions on theory of the light, projects development, domotics, regulation, etc, are carried out.

## A unique place

More than 2,500 luminaires and self-contained emergency lights in total, central battery systems with step lights, light regulators, occupancy detectors... and all of this centered in **NormaLink**, the multi-device and multi-user control platform that makes it possible to combine and manage emergency and conventional lighting in a dynamic and intuitive way.

All in all, it is a unique space that NormaGrup offers to all its customers, contractors, engineers, architects, etc.



## Manufacturing

# From the raw material to the final product

Normagrup designs and manufactures its products entirely in the Company's production factory in Asturias, developing its own technologies with complete control of the technical and logistical processes. We transform raw materials into final products in order to ensure maximum efficiency,

quality, safety and reliability, as well as versatility with high added value in the execution of special projects. A global management, from technological conception to manufacturing, with lines that incorporate the latest advances in electronics, robotics, and automation.

Normagrup researches, develops and manufactures in Spain.







Environmental  
Certification



# Sustainability pioneers

In 2023, Normagrup's two lighting divisions, **Normalux and Normalit**, became the first brands in Spain to obtain the **N Sustainable AENOR certificate** in recognition of their commitment to the environment, society, and governance. The certificate monitors more than 20 sustainability indicators and is evidence of the good environmental practices policy implemented in recent years to

adapt the company to major economic challenges. The implementation of new circular economy and logistical standards and the creation of ecological packaging and sustainable manufacturing practices are part of Normagrup's rigorous strategy to help conserve the planet from Asturias with a global vision.

# Normagrup Lab

Research and  
technology transfer

**Normagrup LAB** is a pioneering innovation center specialized in lighting that combines scientific research and a permanent approach to technology, with the aim of offering the company's customers a unique added value in the product offering and the development of unique projects.

The advanced technological knowledge, R&D's vision of the company and the complete control of the manufacturing process allow us to anticipate the needs in our sector, placing Normagrup on the front line of the global market thanks to its high component of innovation.





## The pieces of Normagrup LAB

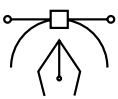

### Department of design

An expert team in industrial and technological design at the service of the aesthetics, ergonomics, and usability of the products to achieve their optimal adaptation to different spaces and ensure their ease of installation and handling.



### Our own laboratories

An R&D center for the development of technologies and the testing of products, guaranteeing the highest quality and safety. Our facilities are equipped with the most advanced equipment; a photogoniometer, Ulbricht sphere, impact hammer, climate chamber, glow wire machine, double monochromator, and spectrophotometer, among other resources.



Get to know our laboratories



### Advanced manufacturing and analysis

As an independent manufacturer, Normagrup has the potential to adapt its production processes to specific requirements. The experience and technical knowledge of the Company is at the service of each project to study and carry out installations in different scenarios, being able to produce customized luminaires for projects that require so.



### Tech Think-Tank

Knowledge as a bulwark of the company to create the foundations of the future, with a multidisciplinary team located at the forefront of research around the field of lighting from various areas.



# Normagrup 360

Special executions and  
customized projects

The manufacturing capacity of Normagrup allows the company to adapt the features of its products to the needs of customers, achieving the production of solutions with a high degree of specialization and uniqueness, as well as an effective execution of special projects.

In addition to guaranteeing the highest quality standards, the services of **Normagrup 360** make it possible to select manufacturing features on demand, allowing the production of bespoke products with special finishes and the desired combination of specifications.



## Customized lighting systems

Customized manufacturing allows an optimal integration and a better performance of the facilities. This is possible thanks to the selection of parameters such as autonomy in emergency lighting solutions or color temperature in conventional luminaires.

### NORMALIT

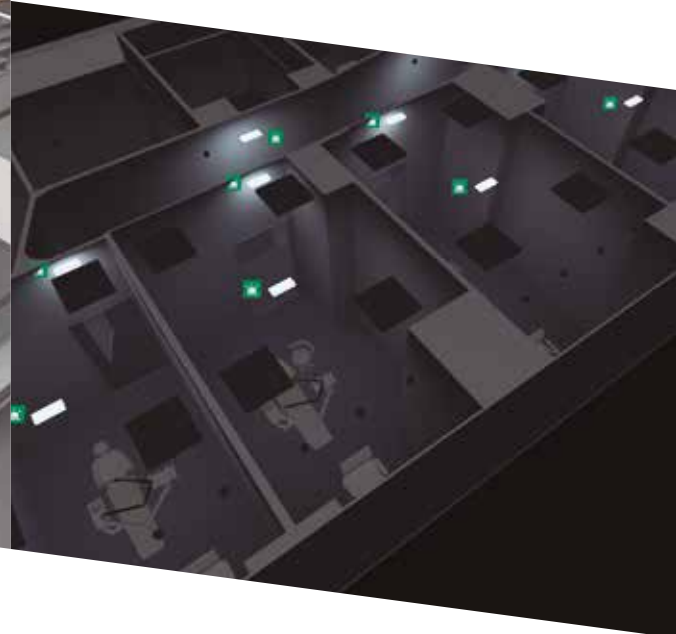
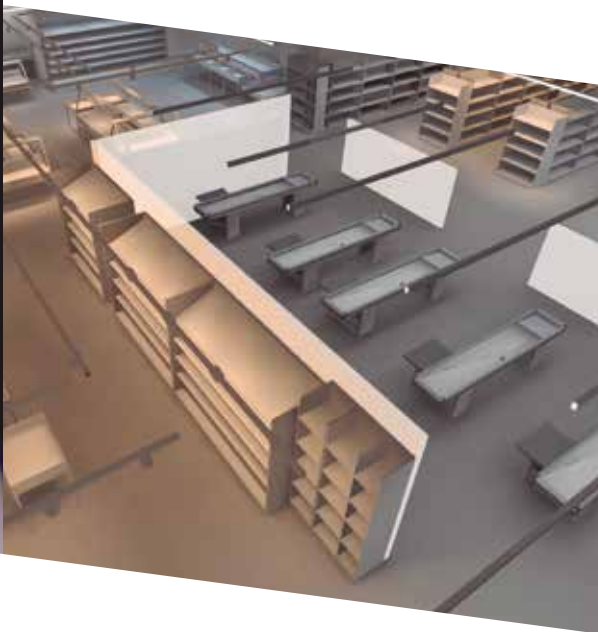
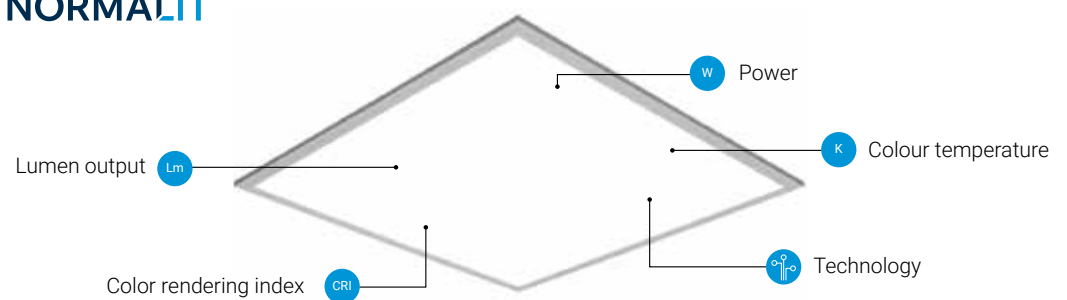

## Manufacturing adaptation and flexibility

Our vision is based on a functional and flexible approach to production, so that the systems adapt to the various spaces and uses from a technical and aesthetic perspective.

## On-demand projects and executions

As a manufacturer, Normagrup accompanies its customers in the development and implementation of customized projects and unique executions with the aim of making any challenge a reality.

## New products 16

## Control System

Normalink App control by Normagrup 18

## SALUZ®

Technology inspired by the sun 21

## Leds food

Enhances the quality of the food 30

# NORMALIT

Technical and architectural lighting

## Recessed downlights

### — Elit



Elit  
41



Elit Max  
47



Elit HR  
51



Elit HR Mini  
55



Elit Mini  
59



Elit Micro  
65

### — Nahika



Nahika  
74



Nahika Q  
78

### — Polart Available in SALUZ®



Nahika Mini  
81



Nahika Micro  
84



Nahika Micro Q  
88



Polart 97 | N



Polart Mini 98 | N



Polart Micro 99 | N



Polart Q 100 | N



Polart Mini Q 101 | N

### — Kuiper



Polart Micro Q 102 | N



Kuiper  
104



Hat  
109



Hat HR  
114  
Available in SALUZ®



Hat Q  
119



Hat Mini  
120



Hat Mini Q  
121



Hat Micro  
122

### — IR / IQ



IR  
124



IQ  
128

### — Tiny



Tiny  
132

### — Dorfin



Dorfin  
137



Dorfin Q  
144

## Surface downlights



Elit S  
150



Hat S  
155



Cyre  
158



Pendulars  
164



Pagoda  
170

## LED Panels



Nassel Avant  
176  
Available in SALUZ®



Nassel  
182



Nassel S  
190



Luzerna Avant  
194  
Available in SALUZ®



SeaLED  
206  
Available in SALUZ®

## Clean rooms



Alba  
218

## Industrial



Mark  
228



Blok Avant  
234



Blok  
240



Blok R  
244



Hermetic Avant  
246



Hermetic Line  
252



Hermetic XL  
258

## Linear luminaires



U-Line  
264



Linnea  
270



Linnea Mixto  
276



Eyre  
278



Trazzo Avant  
286  
Available in S<sub>GLUZ</sub>



Trazzo 70  
305



Trazzo Mixto  
319



Cosmos  
326



Sycom  
332



Coral  
338



Zafiro  
342



LED strips  
347

## Projectors



Silk  
364



Aqa  
372



Dot  
378



Area  
384



Prolit  
394



Avalon  
398



Nora  
406

## Ambient



Mural  
412



Cyre P  
416



Til  
418



Uro  
420



Passo  
422

**NormaLINK**  App control by Normagrup 424

The maintenance factor 438

Lighting technique 440

Guide for regulation control 444

## Normagrup simulator

### Online installation simulations

Normagrup Simulator is the new Normagrup app that allows you to calculate and plan the number of luminaires and their layout quickly and easily with an intelligent online simulator.

As well as creating a customised lighting plan, the digital tool calculates parameters such as maximum, minimum and average lighting, installed power and the energy efficiency rating of the installation (EEVI).

Available at [normalit.com](http://normalit.com)



## Hermetic Avant

### An integral solution

HERMETIC AVANT is a new family of waterproof luminaires from Normalit, highly versatile multipurpose solution designed to adapt to all industrial premises.

- **Top protection (IP66).**
- **Available in three lengths.**
- **Version with occupancy detector.**
- **Quick connection and no disassembly.**

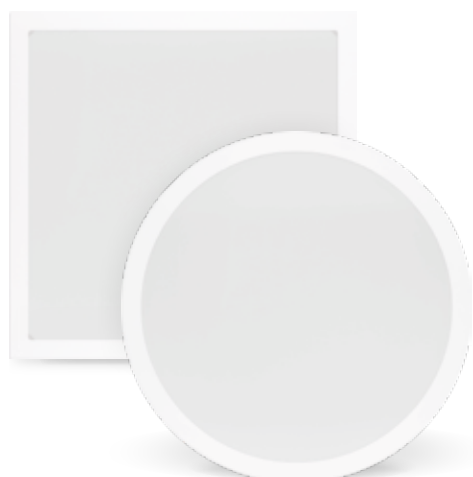

## Polart

### A designer downlight

POLART is the new family of LED downlights from Normalit, a contemporary range that offers new aesthetic possibilities thanks to a minimalist and ecological lighting concept.

- **Two formats and three sizes available.**
- **Two installation types (recessed or ceiling mounted)**
- **New diffuser with two positions.**
- **Three colour temperatures.**
- **Color temperature selector**



⊕ AVAILABLE SALUZ VERSION  
PLEASE CONTACT US

salUZ®





## Silk

### A universal projector

SILK is Normalit's new range of indoor track-mounted mounted projectors. A flexible minimalist architectural lighting solution designed for universal use that adapts to any space.

- Four beam angles (intense 15°, medium 24°, wider angle 36°, very wide ref. PIM 52° / ref. PI 55°)
- Available in black and white.
- Available in two dimensions.



## Avalon

### The full range in one projector

AVALON is Normalit's new range of outdoor projectors, a flexible, innovative range featuring high technology, durability and efficiency to offer the full range of possibilities in a global solution.

- Four versions: standard version, occupancy detector version, twilight sensor version and DIP-Switch or adjustable flow version.
- Choice of seven sizes
- Top protection (IP66).



# NormaLINK

All the control  
in the palm of your hand



Compatible with DALI general lighting and emergency lighting.



Compatible with Emergency lighting

WIRELESS SYSTEM  
**NORMALUX**

sALUZ® Tunable white



DT8

> MODBUS <

Available for IOS, Android  
and Windows.

iOS   Windows

**100%**  
by Normagrup  
hardware · software · support





VIDEO TUTORIALS  
NORMALINK

Normagrup Channel



[normalink.es](https://normalink.es)

See complete information  
on page 424



# SaLUZ®

Technology inspired by the sun

SaLuz® is the technology from Normalit that creates healthy, comfortable and efficient environments

SaLuz® luminaires have been inspired by the sun to adapt to the biological cycles. No network or external device connection is required.



SaLuz® Video  
and more information



## Why some lighting makes us feel good while others create stress?

Light does have an impact on our vital rhythms, as well as on our physiological processes, our mood, our capacity to focus, our emotions and of course, our health.

And, even though artificial lighting is quite useful, our biology is still programmed to adapt to natural lighting, to its cycles and its features.

### **SaLuz® technology is inspired by natural light.**

Thanks to its features, luminaires with SaLuz® technology offer important advantages:

- They adapt to our vital natural rhythms.
- They prevent damages to eyes and skin.
- They prevent headaches, nausea and dizziness.

---

## How does SALUZ® technology work?

SALUZ® is a technology that influences several aspects of the light.



### **Adapts to the circadian rhythm.**

SaLuz® modifies the temperature colour of light through the day, to match our natural biological rhythms, improving the activation level, the mood and the sleep / awake cycle.



### **Flickering control (risk free).**

Flickering are small brightness fluctuations in the artificial lighting that can be perceived as blinks. Prolonged exposure to lights with high flickering can cause headaches, even migraines and nausea. SaLuz® guarantees a flickering risk free.



### **Controls the photobiological safety.**

Luminaires equipped with SaLuz® technology are considered to be risk free for the eye and the skin, according to the European Norm about photobiological safety (EN 62471).



## THE INFLUENCE OF LIGHT IN OUR BRAIN

Vertical eye cut

Transversal eye cut  
(piece of retina)

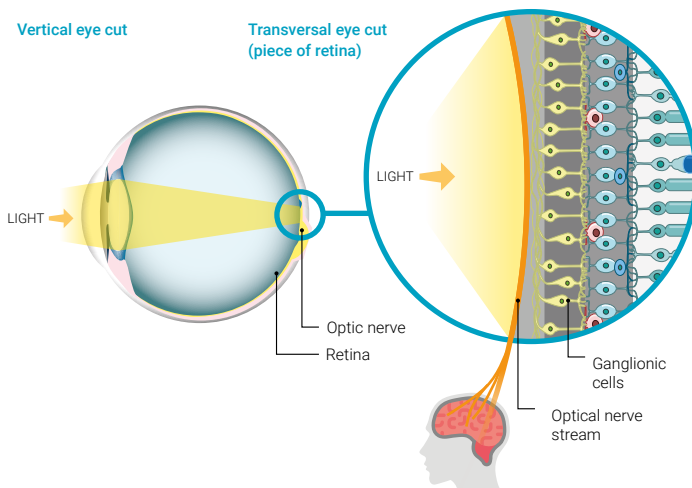

The axions of the ganglionic cells form together the optic nerve, used to provide information to the brain. This information arrives to visual areas forming images, but also to different areas of the brain (non visual) that have to do with other functions, such as regulate the biological clock, hormone production and sleep function, amongst others.

Light with a high predominance of blue stimulates the ganglionic cells in charge of producing the following hormones:

- Dopamine: involved in the muscular coordination, attention and pleasure.
- Serotonin: stimulant and motivator, increasing the levels of energy.
- Cortisol: (Stress hormone), stimulates the metabolism and prepares the body for the day.

This type of light rich in blue content also suppresses the production of melatonin, the hormone that causes tiredness, slows down the activity of the body and reduces activity for a better rest.



## Do you know what Circadian Rythm is and how does it affect your life?

People are naturally synchronized with the sun.

In indoors atmospheres where we usually spend most our our day (offices, schools, etc.), artificial light does not change its tone or its intensity and there is a desynchronization from our vital rythms.

Science has proven that this directly affects our performance, our mood and our sleep.

SaLuz® luminaires reproduce by themselves the luminic cycle of the sun. To do this, we have considered as a reference the sunrise and sunset of Madrid each day of the year, and this has been associated to a light spectrum for each time of the day. This variation of spectra takes place continuously, but is imperceptible with the naked eye. Out of the day cycle, the luminaires emit a spectrum that has been designed to minimize the melatonin inhibition.

SaLuz® synchronizes with our natural rhythms and automatically modifies the colour temperature during the day.







WARM WHITE  
RELAX



NEUTRAL WHITE



COLD WHITE  
ACTIVE

## Areas of installation

SaLuz® technology has been specially thought for indoor atmospheres where there is a constant artificial light all over the day.



### Hospitals

There are patients with a limited mobility that have little exposure to natural light and, hence, to the stimulus that help them synchronize their internal clocks.

SaLuz® technology stabilizes their circadian rhythm. It relaxes or activates them as the sunlight would do, according to the time of the day, and also helps them to improve their sleep.

The professionals looking after them will also improve their performance and well-being.

### Schools

There are many kids that are exposed to unhealthy lighting. Even in places where photobiological risks, flickering and UGR have been considered, they are still exposed to an unsuitable and/or constant colour temperature that makes them lose biological rhythm.

This affects their attention capacity, alters their coordination, their reaction capacity, etc.



In the mornings, the intensity of the light and the proportion of blue light shades help us to be more active. In the evenings, the intensity and the proportion of the blue light shades decreases, which helps us to relax and get ready to rest.

## Easy installation and control

SaLuz® technology is characterized by its easy installation and control, without the need for additional wiring or home automation systems.

The integration of Bluetooth technology allows managing the system from any mobile device in an easy, fast and flexible way. Enjoy automatic and immediate tuning, with significant savings in installation and maintenance costs, as well as a personalized, agile and comfortable control experience using the new SaLuz® *Easy* app.

### Automatic configuration

SaLuz® is the first system available in the market that simulates the circadian rhythm without the need to connect to other equipment.

The luminaires incorporate a clock and a calendar with the date, time and season of the year. Just connect them to the electrical network to implement the solar cycle automatically anywhere in the world.



#### Direct installation to the electrical network

No additional wiring.  
No control elements.  
No start up.  
No setup.



#### Automatic synchronization with the sun

Dynamic simulation of the circadian rhythm.



#### Luminaires connected by Bluetooth

Simple and centralized mobile control.



#### Control up to 20 luminaires

The Bluetooth control module allows you to manage between 15-20 luminaires at the same time.



## Simple and intuitive management

The SaLuz® *Easy* app allows you to manage the SaLuz® system from mobile devices in a simple way and connected via Bluetooth.

A new tool with an intuitive and minimalist design with the latest technology to manage lighting intelligently and dynamically through three control modes, allowing automatic synchronization with the solar cycle in any location, customization of environments, and programming of sequences of daily lighting.

salUZ®  
*Easy* APP CONTROL

FREE APP

Available for IOS and Android



### Manual mode:

Create personalized atmospheres by changing the color temperature and light intensity to adapt the lighting to different spaces, activities and needs, from spaces of maximum concentration to contexts of relaxation.

### Circadian cycle mode:

Enter the location of the mobile device to synchronize SaLuz® with the natural cycle of light instead of where the installation is located and adapt the system to the local circadian cycle automatically and instantly.

### Scheduled mode:

Program daily lighting cycles and sequences in a simple way to configure a personalized system adapted to any space, displaying the programmed routines on a calendar.

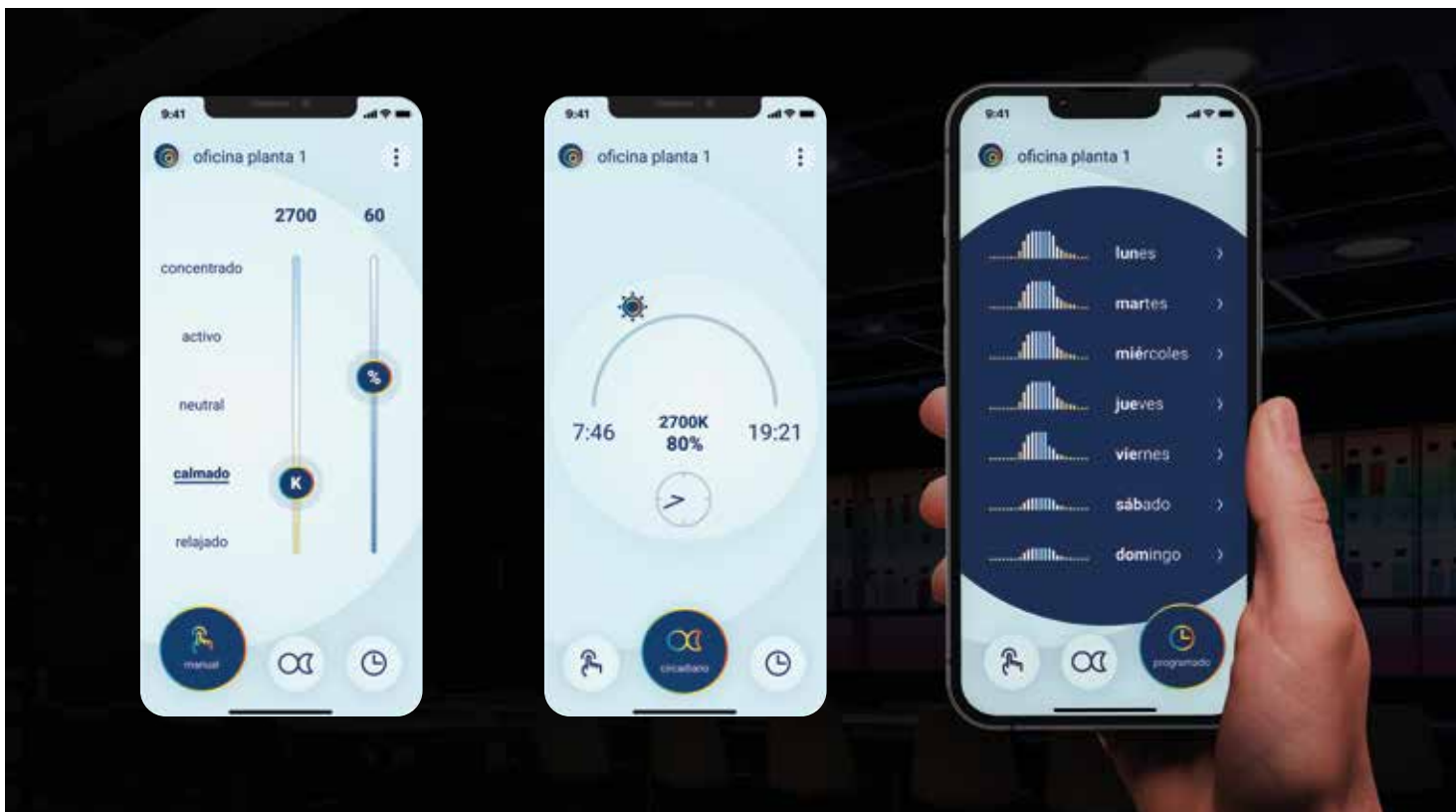

saLUZ®

Luminaires



## Trazzo Avant saLUZ®

IP  
**30**



Ceiling  
surface  
mounted



Ceiling  
suspended  
mounted

Photobiological safety **0**

Flickering **risk free**

UGR **16**

More information **page 291**

## Hat HR saLUZ®

IP  
**54**



Recessed  
in the ceiling

Photobiological safety **0**

Flickering **risk free**

UGR **21**

More information **page 117**

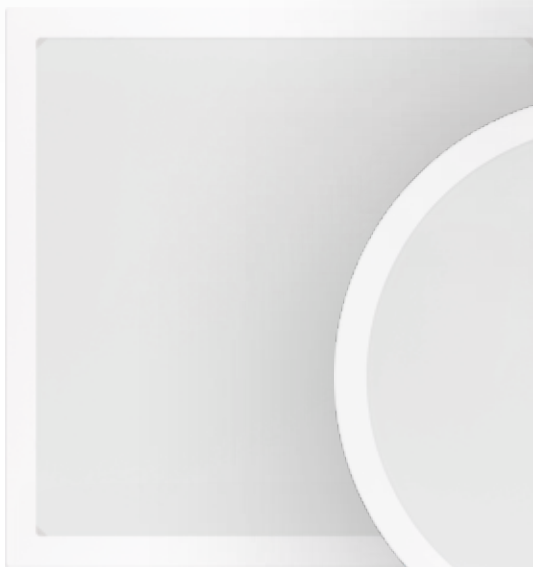
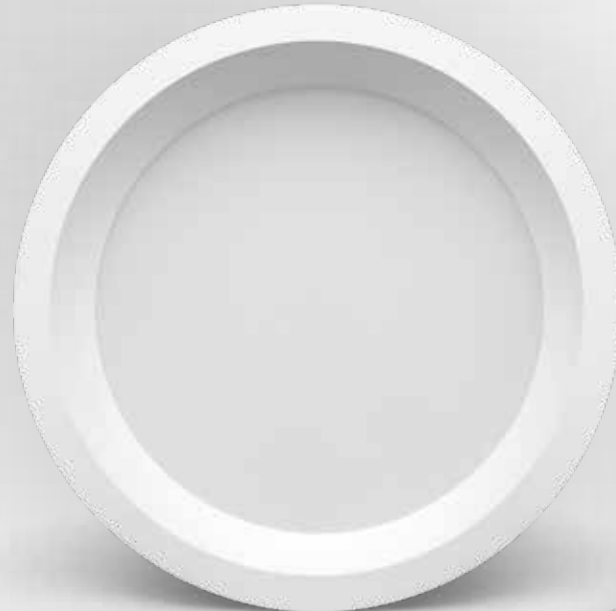

## Polart saLUZ®

IP  
**20-54**



Recessed  
in the  
ceiling

Photobiological safety **0**

Flickering **risk free**

UGR **22**

AVAILABLE SALUZ VERSION  
PLEASE CONTACT US

## Nassel Avant saLUZ®

IP  
**44**



Recessed  
in the ceiling

Photobiological safety **0**

Flickering **risk free**

UGR  **16**



More information **page 180**

## Luzerna Avant saLUZ®

IP  
**20-54**



Recessed  
in the  
ceiling

Photobiological safety **0**

Flickering **risk free**

UGR  **16-19**



More information **page 203**

## SeaLED saLUZ®

IP  
**20-65**



Recessed  
in the  
ceiling

Photobiological safety **0**

Flickering **risk free**

UGR  **16-19**



More information **page 213**

# Leds food

Enhances the quality of the food

LEDS FOOD help to preserve the food. Since they do not generate high working temperatures, they extend the optimal preservation status.



The BREAD LEDS highlight the yellow and orange tones; They are ideal for cheeses, breads or baking products.

#### **BREAD LED**

3000K  
2420 lm  
CRI 85



The FISH LED are ideal for fish illumination. Its cold temperature magnifies the quality of the product.

#### **FISH LED**

5000K  
3250 lm  
CRI 90



The MEAT LEDs highlight the red and pink tones of meat. The result is a more inviting product.

#### **MEAT LED**

4000K  
2315 lm  
CRI 82

## Normalit solutions with leds food



#### **Nahika**

More information [page 77](#)



#### **Dorfin**

More information [page 142](#)



#### **Dorfin Q**

More information [page 146](#)



#### **Pendulars**

More information [page 166](#)



#### **Pagoda**

More information [page 172](#)

LEDS FOOD guarantees an homogeneous working curve as well as a high CRI.

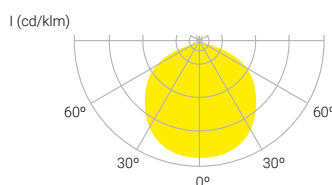

LEDS  
FOOD

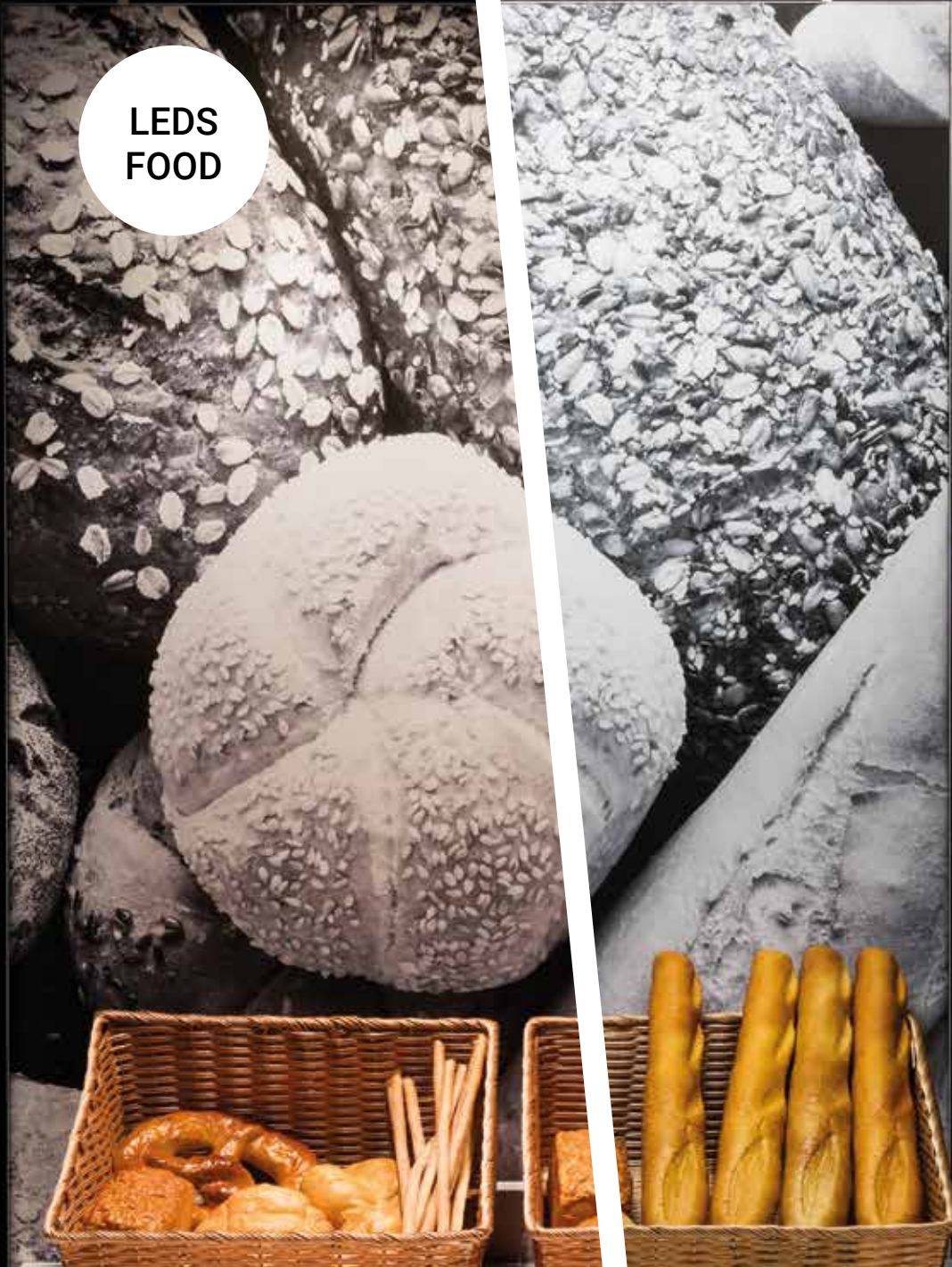

# Recessed downlights





— Elit



Elit  
41



Elit Max  
47



Elit HR  
51



Elit HR Mini  
55



Elit Mini  
59



Elit Micro  
65



Nahika  
74

— Nahika



Nahika Q  
78



Nahika Mini  
81



Nahika Micro  
84



Nahika Micro Q  
88



Polart | N  
97

Available in SÄLUF



Polart Mini | N  
98



Polart Micro | N  
99

— Polart

— Kuiper

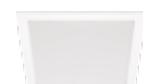

Polart Q | N  
100



Polart Mini Q | N  
101



Polart Micro Q | N  
102



Kuiper  
104

— Hat



Hat  
109



Hat HR  
114

Available in SÄLUF



Hat Q  
119

— IR / IQ

— Tiny

— Dorfin



Hat Mini  
120



Hat Mini Q  
121



Hat Micro  
122



IR  
124



IQ  
128



Tiny  
132



Dorfin  
137



Dorfin Q  
144



# Elit



ELIT is the range of high added value recessed downlights by NormaLit. Their design, their features and their wide range make them the ideal downlight for any type of project.

## Five versions, five diameters

Circular cut diameter

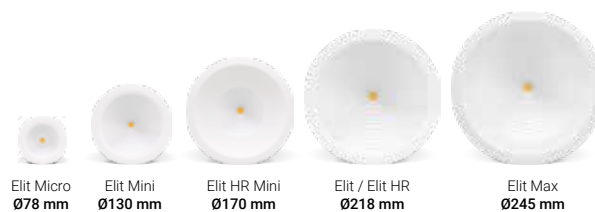

Ceiling recessed mounted



Elit is the perfect balance between design and technology

NUMBER OF FITTINGS NEEDED IN A STANDARD INSTALLATION

EL34

	200 lx	300 lx	500 lx
50 m <sup>2</sup>	4	6	9
100 m <sup>2</sup>	6	9	16
150 m <sup>2</sup>	9	15	22
200 m <sup>2</sup>	12	18	30

Height used for the calculation: 2,8 m



### Designed and manufactured in Spain

Normagrup designs and manufactures all its products in its production plant in Asturias (Spain), with total control over all its technical, industrial and logistical processes. As well as ensuring the highest quality standards, in-house manufacturing enables the company to cut its carbon footprint significantly.



### High-quality materials

Normagrup selects the highest quality electronic materials and lighting components for superior durability and usability in all its products. Skilful design, exclusive finishes and state-of-the-art technologies are an essential part of our corporate identity.

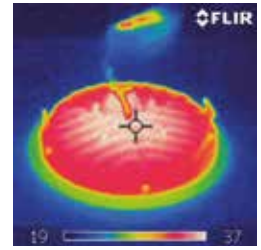

### Laboratory control

Normagrup's R+D centre develops proprietary technologies and conducts comprehensive product testing, complying with the most rigorous quality and safety standards on the market. A technical and innovative vision creates highly efficient, sustainable and healthy solutions to fulfil the new challenges of lighting in the 21st century.

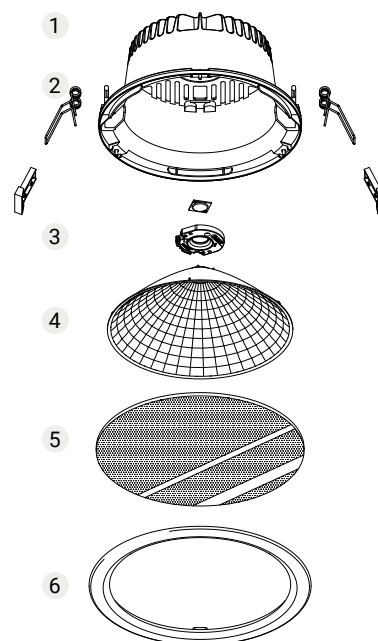

- 1 Aluminium heat sink
- 2 Fixing clamps
- 3 LED COB
- 4 Concentric rings reflector
- 5 Diffuser
- 6 Customizable aluminium ring

Its aluminium housing has been specifically designed to ensure that the temperature of the leds is at an optimum level, to achieve the best efficiency and durability.



Its distinctive reflector made of technical polycarbonate creates a high quality, uniform light without any spots.



**CRI 360** | For other CRI values, please contact us.



Please request technical specifications of all the luminaires or visit our website.

### Elit

### Elit Max

Installation	Ceiling recessed mounted	Ceiling recessed mounted
Diffuser	⊙ ⊙ ⊙ ⊙	⊙ ⊙ ⊙ ⊙
Light source	LED	LED
Photobiological safety	1	1
UGR	19   22	19   22
CRI	>80	>80
MacAdam ellipse	3	3
Beam angle range	95-100	95-100
Power range (W)	11,8-54,6	17,4-54,6
Colour temperature (°K)	3000   4000	3000   4000
Light range	1930-8450	2650-8450
Power factor	0,95	0,95
Efficiency (%)	95,4	95,4
Expectancy	60000 h L70B10	60000 h L70B10
DALI Option	✓	✓
Continuous operation 24h	✓	✓
IP	20-54	20-54
Class	II	II
Ideal cut out (mm)	218	245

Energy efficiency B | C B | C

⊙ Without diffuser ⊙ Opal diffuser ⊙ Transparent diffuser ⊙ Wallwasher diffuser



Without diffuser



Opal diffuser



Transparent diffuser



Wallwasher diffuser

### Elit HR

Ceiling recessed mounted



LED

1

19 | 22

>80

3

92-97

11,8-54,6

3000 | 4000

1930-8450

0,95

95

60000 h L70B10



20-54

II

218

B | C

### Elit HR Mini

Ceiling recessed mounted



LED

1

19 | 22

>80

3

79-83

11,8-54,6

3000 | 4000

1930-8450

0,95

94,8

60000 h L70B10



20-54

II

170

B | C

### Elit Mini

Ceiling recessed mounted



LED

1

19 | 22

>80

4

90-96

14

3000 | 4000

1350-1490

0,95

97,6

60000 h L70B10



20-54

II

130

E

### Elit Micro

Ceiling recessed mounted



LED

1

19 | 22

>80

4

88-94

6,4

3000 | 4000

760-885

0,9

92,9

60000 h L70B10



20-54

II

78

C | D

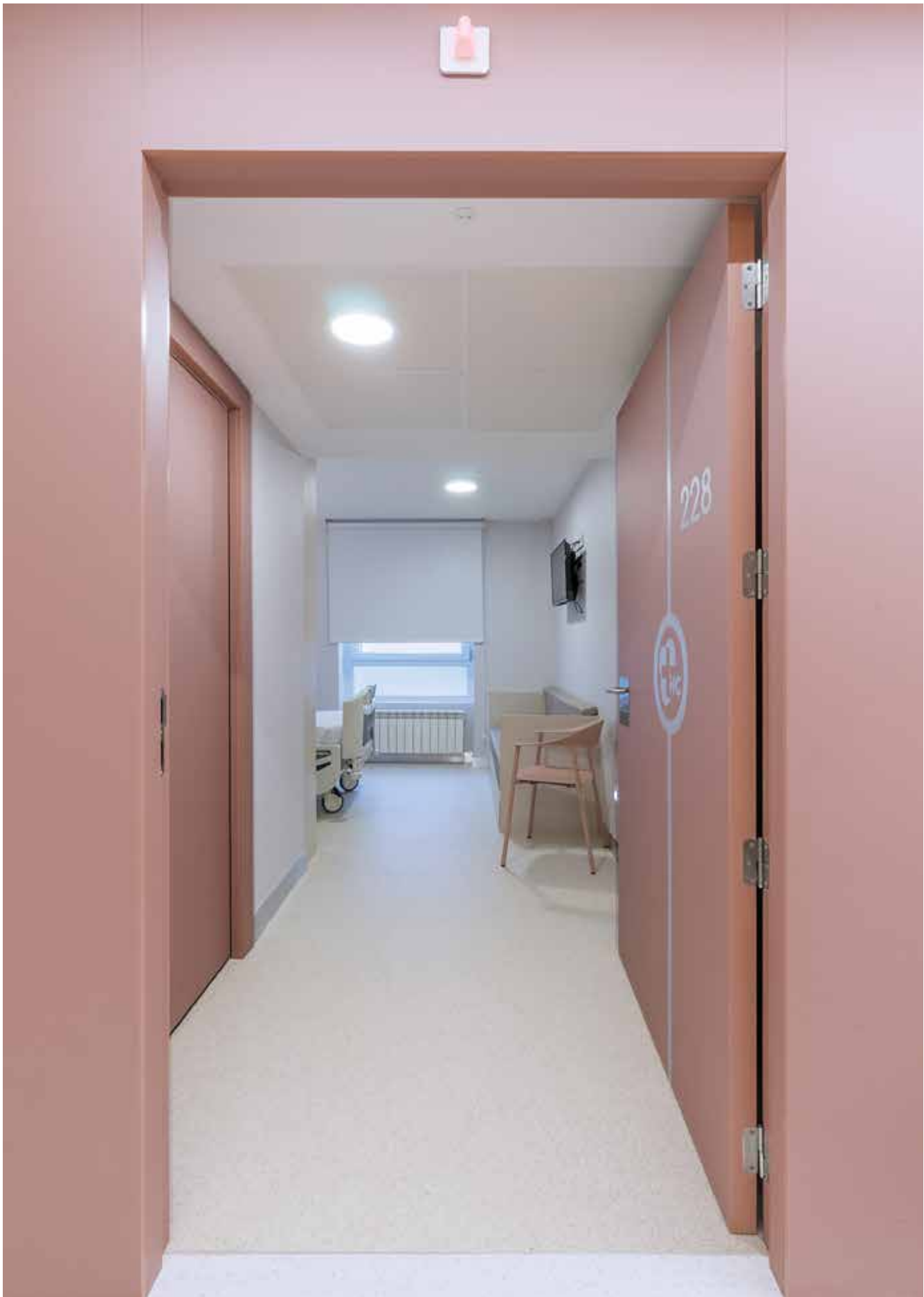

Photography: Natalia Michelena Photo. Architecture: Verónica Durán Se





Available in:

IP65 

# Elit



 **60000 h.**  
L70B10

CRI  
**>80**

 **95-100°**

Efficiency (%)  
**95,4**

Photobiological safety

**RG1\***  Low risk

\*Time under 3 h.

**Go to page 443 to learn more**

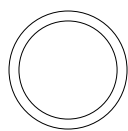

Elit  
Ø230 mm



RAL9016



RAL7001



RAL9005

# Elit

Ceiling recessed mounted

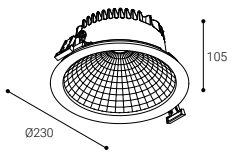

Minimum ceiling installation height  
**155**

Diameter range  
**Ø214-225**  
Ideal cut out  
**Ø218**  
Circular cut

**60000 h.**  
L70B10

CRI  
**>80**

**95-100°**

Efficiency (%)  
**95,4**

Photobiological safety

**RG1\*** **1** Low risk

\*Time under 3h.

Go to page 443 to learn more



## ○ WITHOUT DIFFUSER

	K	REF.	W	LUMEN	⊙	⊙	REF. DALI
IP 20	3000	EL23B	11,8 W	1930 lm	○	0,8	EL23DB
		EL33B	17,4 W	2650 lm	○	0,8	EL33DB
UGR 19	4000	EL43B	25,1 W	3580 lm	○	0,8	EL43DB
		EL63B	35,2 W	5800 lm	○	0,8	EL63DB
		EL83B	54,6 W	8020 lm	○	0,8	EL83DB
		EL24B	11,8 W	2050 lm	○	0,8	EL24DB
		EL34B	17,4 W	2850 lm	○	0,8	EL34DB
	4000	EL44B	25,1 W	3780 lm	○	0,8	EL44DB
		EL64B	35,2 W	6100 lm	○	0,8	EL64DB
		EL84B	54,6 W	8450 lm	○	0,8	EL84DB

- RAL9016
- RAL7001 Replace "B" by "G" in the reference
- RAL9005 Replace "B" by "N" in the reference

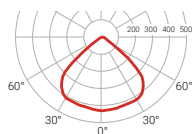

— C0-C180  
— C90-C270  $\eta=95\%$



# Elit

Ceiling recessed mounted

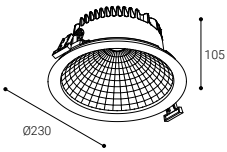

Minimum ceiling installation height  
**155**

Diameter range  
**Ø214-225**

Ideal cut out  
**Ø218**  
Circular cut

**60000 h.**  
L70B10

CRI  
**>80**

Beam angle  
**95-100°**

Efficiency (%)  
**95,4**

Photobiological safety

**RG1\*** **1** Low risk

\*Time under 3 h.

Go to page 443 to learn more



## OPAL DIFFUSER

	K	REF.	W	LUMEN	⊙	⊙	REF. DALI
IP 54	3000	EL23OB	11,8 W	1930 lm	⊙	0,8	EL23DOB
		EL33OB	17,4 W	2650 lm	⊙	0,8	EL33DOB
UGR 22	3000	EL43OB	25,1 W	3580 lm	⊙	0,8	EL43DOB
		EL63OB	35,2 W	5800 lm	⊙	0,8	EL63DOB
		EL83OB	54,6 W	8020 lm	⊙	0,8	EL83DOB
		EL24OB	11,8 W	2050 lm	⊙	0,8	EL24DOB
		EL34OB	17,4 W	2850 lm	⊙	0,8	EL34DOB
4000	4000	EL44OB	25,1 W	3780 lm	⊙	0,8	EL44DOB
		EL64OB	35,2 W	6100 lm	⊙	0,8	EL64DOB
		EL84OB	54,6 W	8450 lm	⊙	0,8	EL84DOB

## IP65

## OPAL DIFFUSER

	K	REF.	W	LUMEN	⊙	⊙	REF. DALI
IP 65	3000	EL23OIB	11,8 W	1930 lm	⊙	0,8	EL23DOIB
		EL33OIB	17,4 W	2650 lm	⊙	0,8	EL33DOIB
UGR 22	3000	EL43OIB	25,1 W	3580 lm	⊙	0,8	EL43DOIB
		EL63OIB	35,2 W	5800 lm	⊙	0,8	EL63DOIB
		EL83OIB	54,6 W	8020 lm	⊙	0,8	EL83DOIB
		EL24OIB	11,8 W	2050 lm	⊙	0,8	EL24DOIB
		EL34OIB	17,4 W	2850 lm	⊙	0,8	EL34DOIB
4000	4000	EL44OIB	25,1 W	3780 lm	⊙	0,8	EL44DOIB
		EL64OIB	35,2 W	6100 lm	⊙	0,8	EL64DOIB
		EL84OIB	54,6 W	8450 lm	⊙	0,8	EL84DOIB

- RAL9016
- RAL7001 Replace "B" by "G" in the reference
- RAL9005 Replace "B" by "N" in the reference

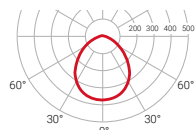

η=85%



# Elit

Ceiling recessed mounted

LED CE RoHS

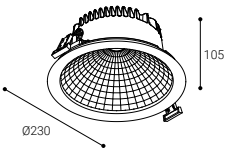

Minimum ceiling installation height  
**155**

Diameter range  
**Ø214-225**  
Ideal cut out  
**Ø218**  
Circular cut

60000 h.  
L70B10

CRI  
**>80**

95-100°

Efficiency (%)  
**95,4**

Photobiological safety

RG1\* **1** Low risk

\*Time under 3h.

Go to page 443 to learn more



## TRANSPARENT DIFFUSER

	K	REF.	W	LUMEN	⊙	⊙	REF. DALI
IP 54	3000	EL23TB	11,8 W	1930 lm	⊙	0,8	EL23DTB
		EL33TB	17,4 W	2650 lm	⊙	0,8	EL33DTB
UGR 19	3000	EL43TB	25,1 W	3580 lm	⊙	0,8	EL43DTB
		EL63TB	35,2 W	5800 lm	⊙	0,8	EL63DTB
		EL83TB	54,6 W	8020 lm	⊙	0,8	EL83DTB
		EL24TB	11,8 W	2050 lm	⊙	0,8	EL24DTB
		EL34TB	17,4 W	2850 lm	⊙	0,8	EL34DTB
4000	4000	EL44TB	25,1 W	3780 lm	⊙	0,8	EL44DTB
		EL64TB	35,2 W	6100 lm	⊙	0,8	EL64DTB
		EL84TB	54,6 W	8450 lm	⊙	0,8	EL84DTB

## IP65

## TRANSPARENT DIFFUSER

	K	REF.	W	LUMEN	⊙	⊙	REF. DALI
IP 65	3000	EL23TIB	11,8 W	1930 lm	⊙	0,8	EL23DTIB
		EL33TIB	17,4 W	2650 lm	⊙	0,8	EL33DTIB
UGR 19	3000	EL43TIB	25,1 W	3580 lm	⊙	0,8	EL43DTIB
		EL63TIB	35,2 W	5800 lm	⊙	0,8	EL63DTIB
		EL83TIB	54,6 W	8020 lm	⊙	0,8	EL83DTIB
		EL24TIB	11,8 W	2050 lm	⊙	0,8	EL24DTIB
		EL34TIB	17,4 W	2850 lm	⊙	0,8	EL34DTIB
4000	4000	EL44TIB	25,1 W	3780 lm	⊙	0,8	EL44DTIB
		EL64TIB	35,2 W	6100 lm	⊙	0,8	EL64DTIB
		EL84TIB	54,6 W	8450 lm	⊙	0,8	EL84DTIB

- RAL9016
- RAL7001 Replace "B" by "G" in the reference
- RAL9005 Replace "B" by "N" in the reference

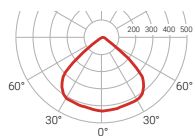

— C0-C180  
— C90-C270  $\eta=93\%$

Compatible with **NormaLINK**

# Elit

Ceiling recessed mounted

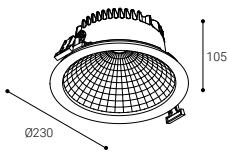

Minimum ceiling installation height  
**155**

Diameter range  
**Ø214-225**

Ideal cut out  
**Ø218**  
Circular cut

**60000 h.**  
L70B10

CRI  
**>80**

**95-100°**

Efficiency (%)  
**95,4**

Photobiological safety

**RG1\*** **1** Low risk

\*Time under 3 h.

Go to page 443 to learn more



## WALLWASHER DIFFUSER

	K	REF.	W	LUMEN			REF. DALI
IP 20	3000	EL23WB	11,8 W	1930 lm	○	0,8	—
		EL33WB	17,4 W	2650 lm	○	0,8	—
UGR 19	4000	EL43WB	25,1 W	3580 lm	○	0,8	—
		EL63WB	35,2 W	5800 lm	○	0,8	EL63DWB
		EL83WB	54,6 W	8020 lm	○	0,8	EL83DWB
		EL24WB	11,8 W	2050 lm	○	0,8	—
		EL34WB	17,4 W	2850 lm	○	0,8	—
	4000	EL44WB	25,1 W	3780 lm	○	0,8	—
		EL64WB	35,2 W	6100 lm	○	0,8	EL64DWB
		EL84WB	54,6 W	8450 lm	○	0,8	EL84DWB

- RAL9016
- RAL7001 Replace "B" by "G" in the reference
- RAL9005 Replace "B" by "N" in the reference

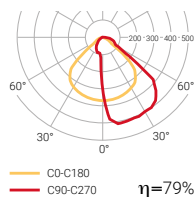

Compatible with **NormaLINK**

# 54,6 W 8450 lm

## Maximum efficiency

Efficiency is not just a matter of performance, but also of technology, design and technical research. Efficient lighting solutions for all types of spaces are characterized by luminaires that project light precisely onto the surface, in order to avoid stray light.





# Elit Max

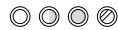

 **60000 h.**  
L70B10

CRI  
**>80**

 **95-100°**

Efficiency (%)  
**95,4**

Photobiological safety

**RG1\***  Low risk

\*Time under 3 h.

**Go to page 443 to learn more**

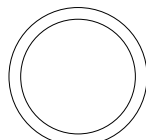

Elit Max  
Ø265 mm



RAL9016



RAL7001



RAL9005

# Elit Max

Ceiling recessed mounted

LED CE ENEC

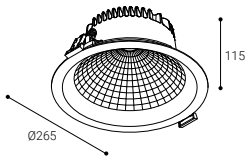

Minimum ceiling installation height  
**165**

Diameter range  
**Ø238-260**  
Ideal cut out  
**Ø245**  
Circular cut

60000 h.  
L70B10

CRI  
**>80**

95-100°

Efficiency (%)  
**95,4**

Photobiological safety

RG1\* **1** Low risk

\*Time under 3h.

Go to page 443 to learn more



## ○ WITHOUT DIFFUSER

	K	REF.	W	LUMEN			REF. DALI
IP 20	3000	EE33B	17,4 W	2650 lm	○	0,9	EE33DB
		EE43B	25,1 W	3580 lm	○	0,9	EE43DB
		EE63B	35,2 W	5800 lm	○	0,9	EE63DB
UGR 19	4000	EE83B	54,6 W	8020 lm	○	0,9	EE83DB
		EE34B	17,4 W	2850 lm	○	0,9	EE34DB
		EE44B	25,1 W	3780 lm	○	0,9	EE44DB
		EE64B	35,2 W	6100 lm	○	0,9	EE64DB
		EE84B	54,6 W	8450 lm	○	0,9	EE84DB

## ○ OPAL DIFFUSER

	K	REF.	W	LUMEN			REF. DALI
IP 54	3000	EE33OB	17,4 W	2650 lm	○	0,9	EE33DOB
		EE43OB	25,1 W	3580 lm	○	0,9	EE43DOB
		EE63OB	35,2 W	5800 lm	○	0,9	EE63DOB
UGR 22	4000	EE83OB	54,6 W	8020 lm	○	0,9	EE83DOB
		EE34OB	17,4 W	2850 lm	○	0,9	EE34DOB
		EE44OB	25,1 W	3780 lm	○	0,9	EE44DOB
		EE64OB	35,2 W	6100 lm	○	0,9	EE64DOB
		EE84OB	54,6 W	8450 lm	○	0,9	EE84DOB

- RAL9016
- RAL7001 Replace "B" by "G" in the reference
- RAL9005 Replace "B" by "N" in the reference

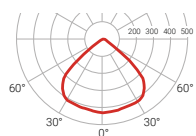

CO-C180  
C90-C270  $\eta=95\%$

DALI Compatible with NormoLINK

- RAL9016
- RAL7001 Replace "B" by "G" in the reference
- RAL9005 Replace "B" by "N" in the reference

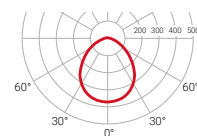

CO-C180  
C90-C270  $\eta=85\%$

DALI Compatible with NormoLINK



# Elit Max

Ceiling recessed mounted

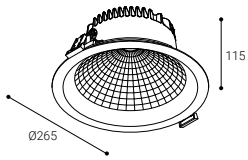

Minimum ceiling installation height  
**165**

Diameter range  
**Ø238-260**  
Ideal cut out  
**Ø245**  
Circular cut

60000 h.  
L70B10

CRI  
**>80**

95-100°

Efficiency (%)  
**95,4**

Photobiological safety

RG1\* **1** Low risk

\*Time under 3 h.

Go to page 443 to learn more



## TRANSPARENT DIFFUSER

	K	REF.	W	LUMEN			REF. DALI	
IP 54	3000	EE33TB	17,4 W	2650 lm	○	0,9	EE33DTB	
		EE43TB	25,1 W	3580 lm	○	0,9	EE43DTB	
UGR 19	3000	EE63TB	35,2 W	5800 lm	○	0,9	EE63DTB	
		EE83TB	54,6 W	8020 lm	○	0,9	EE83DTB	
		4000	EE34TB	17,4 W	2850 lm	○	0,9	EE34DTB
		EE44TB	25,1 W	3780 lm	○	0,9	EE44DTB	
4000	4000	EE64TB	35,2 W	6100 lm	○	0,9	EE64DTB	
		EE84TB	54,6 W	8450 lm	○	0,9	EE84DTB	

## WALLWASHER DIFFUSER

	K	REF.	W	LUMEN			REF. DALI	
IP 20	3000	EE33WB	17,4 W	2650 lm	○	0,9	—	
		EE43WB	25,1 W	3580 lm	○	0,9	—	
UGR 19	3000	EE63WB	35,2 W	5800 lm	○	0,9	EE63DWB	
		EE83WB	54,6 W	8020 lm	○	0,9	EE83DWB	
		4000	EE34WB	17,4 W	2850 lm	○	0,9	—
		EE44WB	25,1 W	3780 lm	○	0,9	—	
4000	4000	EE64WB	35,2 W	6100 lm	○	0,9	EE64DWB	
		EE84WB	54,6 W	8450 lm	○	0,9	EE84DWB	

- RAL9016
- RAL7001 Replace "B" by "G" in the reference
- RAL9005 Replace "B" by "N" in the reference

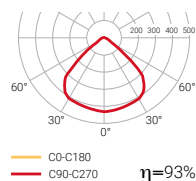

- RAL9016
- RAL7001 Replace "B" by "G" in the reference
- RAL9005 Replace "B" by "N" in the reference

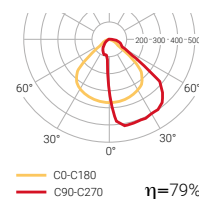





# Elit HR



 **60000 h.**  
L70B10

CRI  
**>80**

 **92-97°**

Efficiency (%)  
**95**

Photobiological safety

**RG1\***  Low risk

\*Time under 3 h.

**Go to page 443 to learn more**

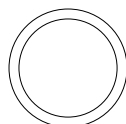

Elit HR  
Ø230 mm



RAL9016



RAL7001



RAL9005

# Elit HR

Ceiling recessed mounted

LED CE RoHS

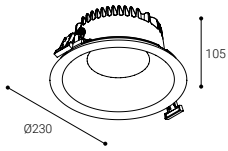

Minimum ceiling installation height  
**155**

Diameter range  
**Ø214-225**  
Ideal cut out  
**Ø218**  
Circular cut

60000 h.  
L70B10

CRI  
**>80**

92-97°

Efficiency (%)  
**95**

Photobiological safety

RG1\* **1** Low risk

\*Time under 3h.

Go to page 443 to learn more



## WITHOUT DIFFUSER

	K	REF.	W	LUMEN			REF. DALI
IP 20	3000	ELI23B	11,8 W	1930 lm	○	1,0	ELI23DB
		ELI33B	17,4 W	2650 lm	○	1,0	ELI33DB
UGR 19	4000	ELI43B	25,1 W	3580 lm	○	1,0	ELI43DB
		ELI63B	35,2 W	5800 lm	○	0,8	ELI63DB
		ELI83B	54,6 W	8020 lm	○	0,8	ELI83DB
		ELI24B	11,8 W	2050 lm	○	1,0	ELI24DB
		ELI34B	17,4 W	2850 lm	○	1,0	ELI34DB
	4000	ELI44B	25,1 W	3780 lm	○	1,0	ELI44DB
		ELI64B	35,2 W	6100 lm	○	0,8	ELI64DB
		ELI84B	54,6 W	8450 lm	○	0,8	ELI84DB

## OPAL DIFFUSER

	K	REF.	W	LUMEN			REF. DALI
IP 54	3000	ELI230B	11,8 W	1930 lm	○	1,0	ELI23DOB
		ELI330B	17,4 W	2650 lm	○	1,0	ELI33DOB
UGR 22	4000	ELI430B	25,1 W	3580 lm	○	1,0	ELI43DOB
		ELI630B	35,2 W	5800 lm	○	0,8	ELI63DOB
		ELI830B	54,6 W	8020 lm	○	0,8	ELI83DOB
		ELI240B	13,0 W	2050 lm	○	1,0	ELI24DOB
		ELI340B	19,1 W	2850 lm	○	1,0	ELI34DOB
	4000	ELI440B	25,1 W	3780 lm	○	1,0	ELI44DOB
		ELI640B	35,2 W	6100 lm	○	0,8	ELI64DOB
		ELI840B	54,6 W	8450 lm	○	0,8	ELI84DOB

- RAL9016
- RAL7001 Replace "B" by "G" in the reference
- RAL9005 Replace "B" by "N" in the reference

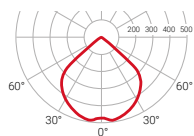

CO-C180  
C90-C270  $\eta=95\%$

DALI Compatible with NormoLINK

- RAL9016
- RAL7001 Replace "B" by "G" in the reference
- RAL9005 Replace "B" by "N" in the reference

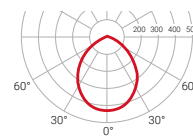

CO-C180  
C90-C270  $\eta=88\%$

DALI Compatible with NormoLINK

# Elit HR

Ceiling recessed mounted

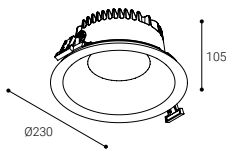

Minimum ceiling installation height  
**155**

Diameter range  
**Ø214-225**  
Ideal cut out  
**Ø218**  
Circular cut

**60000 h.**  
L70B10

CRI  
**>80**

**92-97°**

Efficiency (%)  
**95**

Photobiological safety

**RG1\*** **1** Low risk

\*Time under 3 h.

Go to page 443 to learn more



## © TRANSPARENT DIFFUSER

	K	REF.	W	LUMEN			REF. DALI
IP 54	3000	<b>ELI23TB</b>	11,8 W	1930 lm		1,0	<b>ELI23DTB</b>
		<b>ELI33TB</b>	17,4 W	2650 lm		1,0	<b>ELI33DTB</b>
UGR 19	3000	<b>ELI43TB</b>	25,1 W	3580 lm		1,0	<b>ELI43DTB</b>
		<b>ELI63TB</b>	35,2 W	5800 lm		0,8	<b>ELI63DTB</b>
		<b>ELI83TB</b>	54,6 W	8020 lm		0,8	<b>ELI83DTB</b>
		<b>ELI24TB</b>	11,8 W	2050 lm		1,0	<b>ELI24DTB</b>
4000	4000	<b>ELI34TB</b>	17,4 W	2850 lm		1,0	<b>ELI34DTB</b>
		<b>ELI44TB</b>	25,1 W	3780 lm		1,0	<b>ELI44DTB</b>
		<b>ELI64TB</b>	35,2 W	6100 lm		0,8	<b>ELI64DTB</b>
		<b>ELI84TB</b>	54,6 W	8450 lm		0,8	<b>ELI84DTB</b>

- RAL9016
- RAL7001 Replace "B" by "G" in the reference
- RAL9005 Replace "B" by "N" in the reference

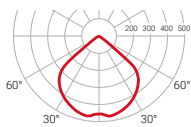

C0-C180  $\eta=92\%$   
C90-C270

Compatible with **NormaLINK**





# Elit HR Mini



 **60000 h.**  
L70B10

CRI  
**>80**

 **79-83°**

Efficiency (%)  
**94,8**

Photobiological safety

**RG1\***  Low risk

\*Time under 3 h.

**Go to page 443 to learn more**

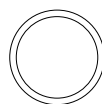

Elit HR Mini  
Ø185 mm



RAL9016



RAL7001



RAL9005

# Elit HR Mini

Ceiling recessed mounted

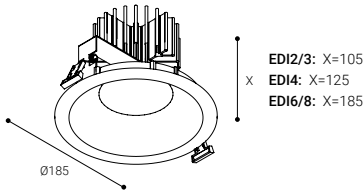

Diameter range  
**Ø165-180**  
Ideal cut out  
**Ø170**  
Circular cut

60000 h.  
L70B10

CRI  
**>80**

79-83°

Efficiency (%)  
**94,8**

Photobiological safety

RG1\* **1** Low risk

\*Time under 3h.

Go to page 443 to learn more



## ○ WITHOUT DIFFUSER

	K	REF.	W	LUMEN			REF. DALI
IP 20	3000	EDI23B	11,8 W	1930 lm	○	1,0	EDI23DB
		EDI33B	17,4 W	2650 lm	○	1,0	EDI33DB
UGR 19	3000	EDI43B	25,1 W	3580 lm	○	1,0	EDI43DB
		EDI63B	35,2 W	5800 lm	○	1,6	EDI63DB
		EDI83B	54,6 W	8020 lm	○	1,6	EDI83DB
		4000	EDI24B	11,8 W	2050 lm	○	1,0
4000	4000	EDI34B	17,4 W	2850 lm	○	1,0	EDI34DB
		EDI44B	25,1 W	3780 lm	○	1,0	EDI44DB
		EDI64B	35,2 W	6100 lm	○	1,7	EDI64DB
		EDI84B	54,6 W	8450 lm	○	1,6	EDI84DB

## ○ OPAL DIFFUSER

	K	REF.	W	LUMEN			REF. DALI
IP 54	3000	EDI23OB	11,8 W	1930 lm	○	1,0	EDI23DOB
		EDI33OB	17,4 W	2650 lm	○	1,0	EDI33DOB
UGR 22	3000	EDI43OB	25,1 W	3580 lm	○	1,0	EDI43DOB
		EDI63OB	35,2 W	5800 lm	○	1,6	EDI63DOB
		EDI83OB	54,6 W	8020 lm	○	1,6	EDI83DOB
		4000	EDI24OB	11,8 W	2050 lm	○	1,0
4000	4000	EDI34OB	17,4 W	2850 lm	○	1,0	EDI34DOB
		EDI44OB	25,1 W	3780 lm	○	1,0	EDI44DOB
		EDI64OB	35,2 W	6100 lm	○	1,6	EDI64DOB
		EDI84OB	54,6 W	8450 lm	○	1,6	EDI84DOB

- RAL9016
- RAL7001 Replace "B" by "G" in the reference
- RAL9005 Replace "B" by "N" in the reference

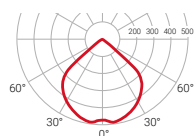

CO-C180  
C90-C270  $\eta=95\%$



- RAL9016
- RAL7001 Replace "B" by "G" in the reference
- RAL9005 Replace "B" by "N" in the reference

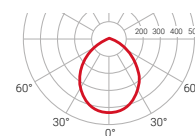

CO-C180  
C90-C270  $\eta=88\%$





# Elit HR Mini

Ceiling recessed mounted

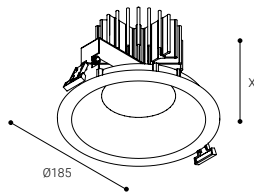

ED12/3: X=105  
ED14: X=125  
ED16/8: X=185

Diameter range  
**Ø165-180**  
Ideal cut out  
**Ø170**  
Circular cut

60000 h.  
L70B10

CRI  
**>80**

79-83°

Efficiency (%)  
**94,8**

Photobiological safety

RG1\* **1** Low risk

\*Time under 3 h.

Go to page 443 to learn more



## TRANSPARENT DIFFUSER

	K	REF.	W	LUMEN			REF. DALI
IP 54	3000	ED123TB	11,8 W	1930 lm	○	1,0	ED123DTB
		ED133TB	17,4 W	2650 lm	○	1,0	ED133DTB
UGR 19	3000	ED143TB	25,1 W	3580 lm	○	1,0	ED143DTB
		ED163TB	35,2 W	5800 lm	○	1,7	ED163DTB
		ED183TB	54,6 W	8020 lm	○	1,6	ED183DTB
		ED124TB	11,8 W	2050 lm	○	1,0	ED124DTB
4000	4000	ED134TB	17,4 W	2850 lm	○	1,0	ED134DTB
		ED144TB	25,1 W	3780 lm	○	1,0	ED144DTB
		ED164TB	35,2 W	6100 lm	○	1,7	ED164DTB
		ED184TB	54,6 W	8450 lm	○	1,6	ED184DTB

- RAL9016
- RAL7001 Replace "B" by "G" in the reference
- RAL9005 Replace "B" by "N" in the reference

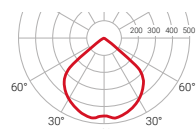

— C0-C180  
— C90-C270  $\eta=92\%$

**DALI** Compatible with **NormaLINK**



Oficinas centrales de Maycroft Construction.





# Elit Mini

Available in:

IP65 

⊙ ⊙ ⊙

 <b>60000 h.</b> L70B10	CRI <b>&gt;80</b>	 <b>90-96°</b>	Efficiency (%) <b>97,6</b>
---------------------------------------------------------------------------------------------------------------	----------------------	---------------------------------------------------------------------------------------------------	-------------------------------

Photobiological safety

**RG1\***  Low risk

\*Time under 3 h.

Go to page 443 to learn more



Elit Mini  
Ø140 mm



RAL9016



RAL7001



RAL9005

# Elit Mini

Ceiling recessed mounted

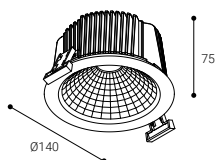

Minimum ceiling installation height  
**127**

Diameter range  
**Ø128-135**  
Ideal cut out  
**Ø130**  
Circular cut

**60000 h.**  
L70B10

CRI  
**>80**

**90-96°**

Efficiency (%)  
**97,6**

Photobiological safety

**RG1\*** **1** Low risk

\*Time under 3h.

Go to page 443 to learn more



## ○ WITHOUT DIFFUSER

	K	REF.	W	LUMEN			REF. DALI
IP 20	3000	<b>EM13B</b>	14 W	1350 lm	○	0,6	<b>EM13DB</b>
UGR 19	4000	<b>EM14B</b>	14 W	1490 lm	○	0,6	<b>EM14DB</b>

- **RAL9016**
- **RAL7001** Replace "B" by "G" in the reference
- **RAL9005** Replace "B" by "N" in the reference

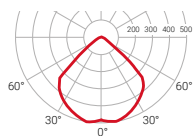

— C0-C180  
— C90-C270  $\eta=97\%$

Compatible with **NormaLINK**

# Elit Mini

Ceiling recessed mounted

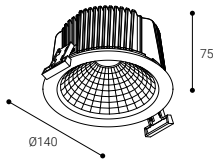

Minimum ceiling installation height  
**127**

Diameter range  
**Ø128-135**  
Ideal cut out  
**Ø130**  
Circular cut

**60000 h.**  
L70B10

CRI  
**>80**

**90-96°**

Efficiency (%)  
**97,6**

Photobiological safety

**RG1\*** **1** Low risk

\*Time under 3 h.

Go to page 443 to learn more



## OPAL DIFFUSER

	K	REF.	W	LUMEN			REF. DALI
IP <b>54</b>	3000	<b>EM130B</b>	14 W	1350 lm		0,6	<b>EM13DOB</b>
UGR <b>22</b>	4000	<b>EM140B</b>	14 W	1490 lm		0,6	<b>EM14DOB</b>

## IP65

## OPAL DIFFUSER

	K	REF.	W	LUMEN			REF. DALI
IP <b>65</b>	3000	<b>EM130IB</b>	14 W	1350 lm		0,6	<b>EM13DOIB</b>
UGR <b>22</b>	4000	<b>EM140IB</b>	14 W	1490 lm		0,6	<b>EM14DOIB</b>

- RAL9016
- RAL7001 Replace "B" by "G" in the reference
- RAL9005 Replace "B" by "N" in the reference

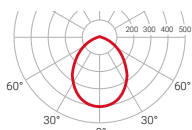

C0-C180  $\eta=84\%$   
C90-C270

Compatible with **NormaLINK**

# Elit Mini

Ceiling recessed mounted

LED CE RoHS

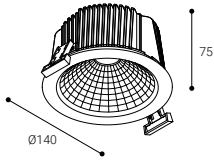

Minimum ceiling installation height  
**127**

Diameter range  
**Ø128-135**  
Ideal cut out  
**Ø130**  
Circular cut

60000 h.  
L70B10

CRI  
**>80**

90-96°

Efficiency (%)  
**97,6**

Photobiological safety

RG1\* **1** Low risk

\*Time under 3h.

Go to page 443 to learn more



## © TRANSPARENT DIFFUSER

	K	REF.	W	LUMEN			REF. DALI
IP 54	3000	EM13TB	14 W	1350 lm		0,6	EM13DTB
UGR 19	4000	EM14TB	14 W	1490 lm		0,6	EM14DTB

## IP65

## TRANSPARENT DIFFUSER

	K	REF.	W	LUMEN			REF. DALI
IP 65	3000	EM13TIB	14 W	1350 lm		0,6	EM13DTIB
UGR 19	4000	EM14TIB	14 W	1490 lm		0,6	EM14DTIB

- RAL9016
- RAL7001 Replace "B" by "G" in the reference
- RAL9005 Replace "B" by "N" in the reference

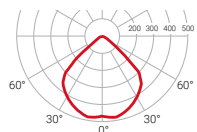

C0-C180  $\eta=93\%$   
C90-C270

Compatible with NormaLINK



Photography Luis Díaz Diaz. Architecture: F5 Proyectos y Arquitectura.









Available in:

IP65 

# Elit Micro

⊙ ⊙ ⊙

 <b>60000 h.</b> L70B10	CRI <b>&gt;80</b>	 <b>88-94°</b>	Efficiency (%) <b>92,9</b>
---------------------------------------------------------------------------------------------------------------	----------------------	---------------------------------------------------------------------------------------------------	-------------------------------

Photobiological safety

**RG1\***  Low risk

\*Time under 3 h.

**Go to page 443 to learn more**

  
Elit Micro  
Ø85 mm



RAL9016



RAL7001



RAL9005

# Elit Micro

Ceiling recessed mounted

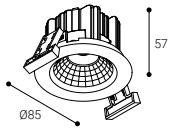

Minimum ceiling installation height  
**110**

Diameter range  
**Ø74-80**  
Ideal cut out  
**Ø78**  
Circular cut

**60000 h.**  
L70B10

CRI  
**>80**

**88-94°**

Efficiency (%)  
**92,9**

Photobiological safety

**RG1\*** **1** Low risk

\*Time under 3h.

**Go to page 443 to learn more**



## ○ WITHOUT DIFFUSER

	K	REF.	W	LUMEN			REF. DALI
IP <b>20</b>	3000	<b>EP03B</b>	6,4 W	760 lm	○	0,3	<b>EP03DB</b>
UGR <b>19</b>	4000	<b>EP04B</b>	6,4 W	885 lm	○	0,3	<b>EP04DB</b>

- **RAL9016**
- **RAL7001** Replace "B" by "G" in the reference
- **RAL9005** Replace "B" by "N" in the reference

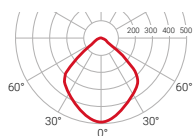

— C0-C180  
— C90-C270 **η=93%**

**DALI** Compatible with **NormaLINK**

# Elit Micro

Ceiling recessed mounted

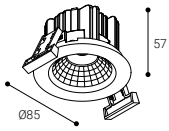

Minimum ceiling installation height  
**110**

Diameter range  
**Ø74-80**  
Ideal cut out  
**Ø78**  
Circular cut

60000 h.  
L70B10

CRI  
**>80**

88-94°

Efficiency (%)  
**92,9**

Photobiological safety

RG1\* **1** Low risk

\*Time under 3 h.

Go to page 443 to learn more



## OPAL DIFFUSER

	K	REF.	W	LUMEN			REF. DALI
IP 54	3000	EP03OB	6,4 W	760 lm		0,3	EP03DOB
UGR 22	4000	EP04OB	6,4 W	885 lm		0,3	EP04DOB

## IP65

## OPAL DIFFUSER

	K	REF.	W	LUMEN			REF. DALI
IP 65	3000	EP03OIB	6,4 W	760 lm		0,3	EP03DOIB
UGR 22	4000	EP04OIB	6,4 W	885 lm		0,3	EP04DOIB

- RAL9016
- RAL7001 Replace "B" by "G" in the reference
- RAL9005 Replace "B" by "N" in the reference

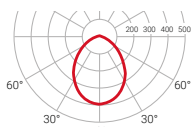

C0-C180  $\eta=80\%$   
C90-C270



# Elit Micro

Ceiling recessed mounted

LED CE RoHS

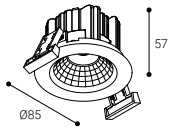

Minimum ceiling installation height  
**110**

Diameter range  
**Ø74-80**  
Ideal cut out  
**Ø78**  
Circular cut

60000 h.  
L70B10

CRI  
**>80**

88-94°

Efficiency (%)  
**92,9**

Photobiological safety

RG1\* **1** Low risk

\*Time under 3h.

Go to page 443 to learn more



## TRANSPARENT DIFFUSER

	K	REF.	W	LUMEN			REF. DALI
IP 54	3000	EP03TB	6,4 W	760 lm		0,3	EP03DTB
UGR 19	4000	EP04TB	6,4 W	885 lm		0,3	EP04DTB

## IP65

## TRANSPARENT DIFFUSER

	K	REF.	W	LUMEN			REF. DALI
IP 65	3000	EP03TIB	6,4 W	760 lm		0,3	EP03DTIB
UGR 19	4000	EP04TIB	6,4 W	885 lm		0,3	EP04DTIB

- RAL9016
- RAL7001 Replace "B" by "G" in the reference
- RAL9005 Replace "B" by "N" in the reference

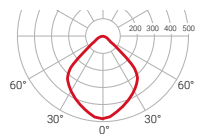

$\eta=88\%$

Compatible with NormaLINK





# Nahika



NAHIKA is a range of downlights available in three sizes in rounded or square shapes.

## Five versions, five diameters

Circular cut diameters

Square cut diameters



Nahika  
Ø218 mm



Nahika Mini  
Ø125 mm



Nahika Micro  
Ø78 mm



Nahika Q  
216x216 mm



Nahika Micro Q  
78x78 mm

Ceiling recessed mounted

They incorporate a high-performance aluminium heat sink which optimises the efficiency of the set.

Installation frame manufactured in aluminium and decorative frame in technical plastic. A wallwasher version is also available.



Ceiling installation is achieved by means of a simple fixation system



## Nahika

Installation Ceiling recessed mounted

Diffuser ○ ○ ○

Light source LED

Photobiological safety 1

UGR 19 | 22

CRI >80-95

MacAdam ellipse 3

Beam angle range 95-99

Power range (W) 17,4-54,6

Colour temperature (°K) 2700 | 3000 | 4000 | 5000

Light range 2315-8450

Power factor 0,95

Efficiency (%) 95,4

Expectancy 60000 h L70B10

DALI Option ✓

Continuous operation 24h ✓

IP 20-54

Class II

Ideal cut out (mm) 218

Energy efficiency B | C | D | E | G

○ Without diffuser   ○ Opal diffuser   ○ Transparent diffuser

CRI 360 | For other CRI values, please contact us.



Please request technical specifications of all the luminaires or visit our website.





### Nahika Q

Ceiling recessed mounted



LED

1

19 | 22

>80-95

3

95

17,4-54,6

2700 | 3000 | 4000 | 5000

2315-8450

0,95

95

60000 h L70B10

✓

✓

20-54

II

216x216

B|C|D|E|G

### Nahika Mini

Ceiling recessed mounted



LED

1

19 | 22

>80

4

90-96

14

3000 | 4000

1350-1490

0,95

97,6

60000 h L70B10

✓

✓

20-54

II

125

E

### Nahika Micro

Ceiling recessed mounted



LED

1

19

>80

4

32-51

14

3000 | 4000

1350-1490

0,95

92,2

60000 h L70B10

✓

✓

20

II

78

E

### Nahika Micro Q

Ceiling recessed mounted



LED

1

19

>80

4

32-51

14

3000 | 4000

1350-1490

0,95

92,2

60000 h L70B10

✓

✓

20

II

78x78

E





# Nahika

Available in:

Led food

SPECIAL COLOUR  
TEMPERATURE  
FOR FOOD INDUSTRY



	<b>60000 h.</b> L70B10	CRI <b>&gt;80-95</b>	 <b>95-99°</b>	Efficiency (%) <b>95,4</b>
-------------------------------------------------------------------------------------	---------------------------	-------------------------	------------------------------------------------------------------------------------------------------	-------------------------------

Photobiological safety

RG1\*  Low risk

\*Time under 3 h.

Go to page 443 to learn more

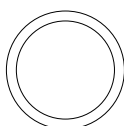

Nahika  
Ø230 mm

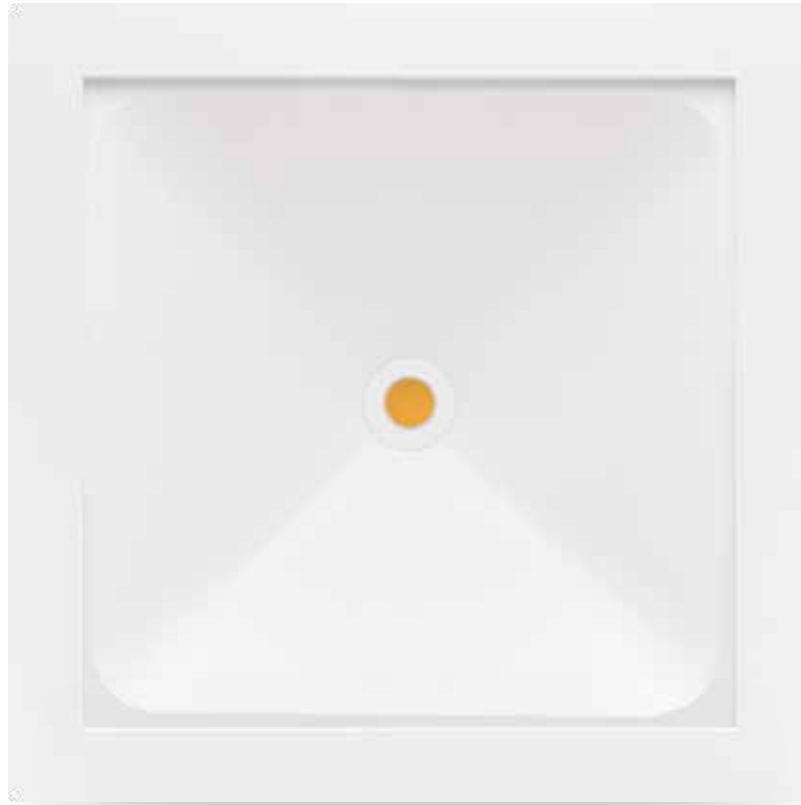

# Nahika Q



**60000 h.**  
L70B10

CRI  
**>80-95**



**95°**

Efficiency (%)  
**95**

Photobiological safety

**RG1\*** **1** Low risk

\*Time under 3 h.

**Go to page 443 to learn more**

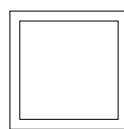

Nahika Q  
230x230 mm

Available in:

Led food

SPECIAL COLOUR  
TEMPERATURE  
FOR FOOD INDUSTRY



# Nahika

Ceiling recessed mounted

LED CE RoHS

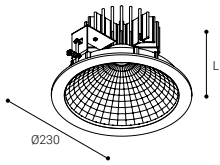

WLR3: L=110  
WLR4: L=130  
WLR5: L=150  
WLR6: L=190  
WLRFB/F/M: L=150

Ideal cut out  
**Ø218**  
Circular cut

60000 h.  
L70B10

CRI  
**>80-95**

95-99°

Efficiency (%)  
**95,4**

Photobiological safety

RG1\* **1** Low risk

\*Time under 3h.

Go to page 443 to learn more



## WITHOUT DIFFUSER

	K	REF.	W	LUMEN			REF. DALI
IP 20	3000	WLR33B	17,4 W	2650 lm	○	1,3	WLR33DB
		WLR43B	25,1 W	3580 lm	○	1,5	WLR43DB
UGR 19	3000	WLR53B	39,4 W	4750 lm	○	1,5	WLR53DB
		WLR63B	35,2 W	5800 lm	○	1,5	WLR63DB
		WLR83B	54,6 W	8020 lm	○	1,5	WLR83DB
		WLR34B	17,4 W	2850 lm	○	1,3	WLR34DB
		WLR44B	25,1 W	3780 lm	○	1,5	WLR44DB
4000	4000	WLR54B	39,4 W	4980 lm	○	1,5	WLR54DB
		WLR64B	35,2 W	6100 lm	○	1,5	WLR64DB
		WLR84B	54,6 W	8450 lm	○	1,5	WLR84DB

## OPAL DIFFUSER

	K	REF.	W	LUMEN			REF. DALI
IP 54	3000	WLR33OB	17,4 W	2650 lm	○	1,5	WLR33DOB
		WLR43OB	25,1 W	3580 lm	○	1,6	WLR43DOB
UGR 22	3000	WLR53OB	39,4 W	4750 lm	○	1,6	WLR53DOB
		WLR63OB	35,2 W	5800 lm	○	1,5	WLR63DOB
		WLR83OB	54,6 W	8020 lm	○	1,6	WLR83DOB
		WLR34OB	17,4 W	2850 lm	○	1,5	WLR34DOB
		WLR44OB	25,1 W	3780 lm	○	1,6	WLR44DOB
4000	4000	WLR54OB	39,4 W	4980 lm	○	1,6	WLR54DOB
		WLR64OB	35,2 W	6100 lm	○	1,5	WLR64DOB
		WLR84OB	54,6 W	8450 lm	○	1,6	WLR84DOB

○ RAL9016

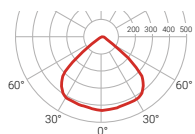

— CO-C180  
— C90-C270  $\eta=95\%$

DALI Compatible with NormaLINK

○ RAL9016

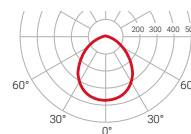

— CO-C180  
— C90-C270  $\eta=85\%$

DALI Compatible with NormaLINK

# Nahika

Ceiling recessed mounted

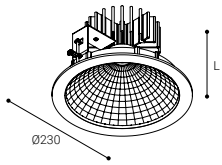

WLR3: L=110  
 WLR4: L=130  
 WLR5: L=150  
 WLR6: L=190  
 WLRFB/F/M: L=150

Ideal cut out  
**Ø218**  
 Circular cut

60000 h.  
 L70B10

CRI  
**>80-95**

95-99°

Efficiency (%)  
**95,4**

Photobiological safety

RG1\* **1** Low risk

\*Time under 3 h.

Go to page 443 to learn more



## TRANSPARENT DIFFUSER

	K	REF.	W	LUMEN			REF. DALI
IP 54	3000	WLR33TB	17,4 W	2650 lm	○	1,5	WLR33DTB
		WLR43TB	25,1 W	3580 lm	○	1,6	WLR43DTB
UGR 19	4000	WLR53TB	39,4 W	4750 lm	○	1,6	WLR53DTB
		WLR63TB	35,2 W	5800 lm	○	1,5	WLR63DTB
		WLR83TB	54,6 W	8020 lm	○	1,6	WLR83DTB
		WLR34TB	17,4 W	2850 lm	○	1,5	WLR34DTB
		WLR44TB	25,1 W	3780 lm	○	1,6	WLR44DTB
		WLR54TB	39,4 W	4980 lm	○	1,6	WLR54DTB
		WLR64TB	35,2 W	6100 lm	○	1,5	WLR64DTB
		WLR84TB	54,6 W	8450 lm	○	1,5	WLR84DTB

○ RAL9016

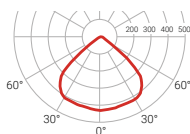

— CG-C180  
 — C90-C270  
 η=93%



## Led food

### SPECIAL COLOUR TEMPERATURE FOR FOOD INDUSTRY

Led Bread	Led Meat	Led Fish
WLRBB 3000K 2540 lm CRI 85	WLRMB 4000K 2315 lm CRI 82	WLRFB 5000K 3250 lm CRI 90

K	REF.	W	LUMEN		
2700	WLRBB	24,5 W	2365 lm	○	1,5
4000	WLRMB	39,4 W	2315 lm	○	1,5
5000	WLRFB	25,5 W	3250 lm	○	1,5

# Nahika Q

Ceiling recessed mounted

LED CE RoHS

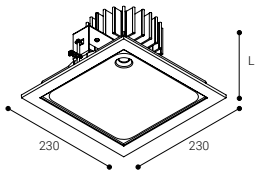

WLQ3: L=110  
 WLQ4: L=130  
 WLQ5: L=150  
 WLQ6: L=190  
 WLQ8B/FB/MB: L=150



Ideal cut out  
**216x216**  
 Square cut

60000 h.  
 L70B10

CRI  
**>80-95**

95°

Efficiency (%)  
**95**

Photobiological safety

RG1\* **1** Low risk

\*Time under 3 h.

Go to page 443 to learn more

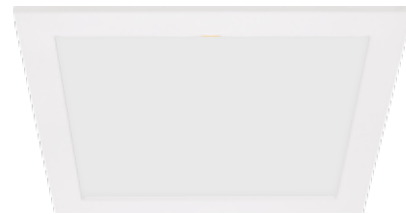

## ○ WITHOUT DIFFUSER

	K	REF.	W	LUMEN			REF. DALI	
IP 20	3000	WLQ33B	17,4 W	2650 lm	○	1,5	WLQ33DB	
		WLQ43B	25,1 W	3580 lm	○	1,5	WLQ43DB	
UGR 19	3000	WLQ53B	39,4 W	4750 lm	○	1,5	WLQ53DB	
		WLQ63B	35,2 W	5800 lm	○	1,5	WLQ63DB	
		WLQ83B	54,6 W	8020 lm	○	1,5	WLQ83DB	
		4000	WLQ34B	17,4 W	2850 lm	○	1,3	WLQ34DB
		4000	WLQ44B	25,1 W	3780 lm	○	1,5	WLQ44DB
		WLQ54B	39,4 W	4980 lm	○	1,6	WLQ54DB	
		WLQ64B	35,2 W	6100 lm	○	1,5	WLQ64DB	
		WLQ84B	54,6 W	8450 lm	○	1,5	WLQ84DB	

## ○ OPAL DIFFUSER

	K	REF.	W	LUMEN			REF. DALI	
IP 54	3000	WLQ33OB	17,4 W	2650 lm	○	1,5	WLQ33DOB	
		WLQ43OB	25,1 W	3580 lm	○	1,6	WLQ43DOB	
UGR 22	3000	WLQ53OB	39,4 W	4750 lm	○	1,6	WLQ53DOB	
		WLQ63OB	35,2 W	5800 lm	○	1,5	WLQ63DOB	
		WLQ83OB	54,6 W	8020 lm	○	1,6	WLQ83DOB	
		4000	WLQ34OB	17,4 W	2850 lm	○	1,5	WLQ34DOB
		4000	WLQ44OB	25,1 W	3780 lm	○	1,6	WLQ44DOB
		WLQ54OB	39,4 W	4980 lm	○	1,6	WLQ54DOB	
		WLQ64OB	35,2 W	6100 lm	○	1,5	WLQ64DOB	
		WLQ84OB	54,6 W	8450 lm	○	1,6	WLQ84DOB	

○ RAL9016

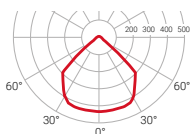

— C0-C180  
 — C90-C270  $\eta=95\%$

DALI Compatible with NormaLINK

○ RAL9016

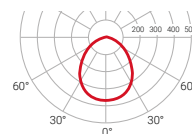

— C0-C180  
 — C90-C270  $\eta=86\%$

DALI Compatible with NormaLINK

# Nahika Q

Ceiling recessed mounted

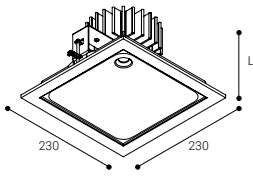

WLQ3: L=110  
 WLQ4: L=130  
 WLQ5: L=150  
 WLQ6: L=190  
 WLQBB/FB/MB: L=150

216x216  
 Ideal cut out  
**216x216**  
 Square cut

60000 h.  
 L70B10

CRI  
**>80-95**

95°

Efficiency (%)  
**95**

Photobiological safety

RG1\* **1** Low risk

\*Time under 3 h.

Go to page 443 to learn more



## © TRANSPARENT DIFFUSER

	K	REF.	W	LUMEN			REF. DALI
IP 54	3000	WLQ33TB	17,4 W	2650 lm		1,5	WLQ33DTB
		WLQ43TB	25,1 W	3580 lm		1,6	WLQ43DTB
UGR 19	3000	WLQ53TB	39,4 W	4750 lm		1,6	WLQ53DTB
		WLQ63TB	35,2 W	5800 lm		1,5	WLQ63DTB
		WLQ83TB	54,6 W	8020 lm		1,6	WLQ83DTB
		WLQ34TB	17,4 W	2850 lm		1,5	WLQ34DTB
		WLQ44TB	25,1 W	3780 lm		1,6	WLQ44DTB
		WLQ54TB	39,4 W	4980 lm		1,6	WLQ54DTB
4000	4000	WLQ64TB	35,2 W	6100 lm		1,5	WLQ64DTB
		WLQ84TB	54,6 W	8450 lm		1,6	WLQ84DTB

RAL9016

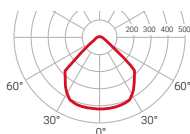

— C0-C180  
 — C90-C270  $\eta=91\%$

Compatible with

## Led food

### SPECIAL COLOUR TEMPERATURE FOR FOOD INDUSTRY

Led Bread	Led Meat	Led Fish
WLRBB 3000K 2540 lm CRI 85	WLRMB 4000K 2315 lm CRI 82	WLRFB 5000K 3250 lm CRI 90

K	REF.	W	LUMEN		
3000	WLQBB	24,5 W	2365 lm		1,5
4000	WLQMB	39,4 W	2315 lm		1,5
5000	WLQFB	25,5 W	3250 lm		1,5







# Nahika Mini



 **60000 h.**  
L70B10

CRI  
**>80**

 **90-96°**

Efficiency (%)  
**97,6**

Photobiological safety

**RG1\***  **1** Low risk

\*Time under 3 h.

**Go to page 443 to learn more**



Nahika Mini  
Ø140 mm

# Nahika Mini

Ceiling recessed mounted

LED CE RoHS

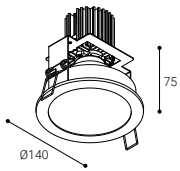

Ideal cut out  
**Ø125**  
Circular cut

60000 h.  
L70B10

CRI  
**>80**

90-96°

Efficiency (%)  
**97,6**

Photobiological safety

RG1\* **1** Low risk

\*Time under 3h.

Go to page 443 to learn more



## ○ WITHOUT DIFFUSER

	K	REF.	W	LUMEN			REF. DALI
IP <b>20</b>	3000	<b>WLMR13B</b>	14 W	1350 lm	○	1,1	<b>WLMR13DB</b>
UGR <b>19</b>	4000	<b>WLMR14B</b>	14 W	1490 lm	○	1,1	<b>WLMR14DB</b>

## ○ OPAL DIFFUSER

	K	REF.	W	LUMEN			REF. DALI
IP <b>54</b>	3000	<b>WLMR130B</b>	14 W	1350 lm	○	1,1	<b>WLMR13DOB</b>
UGR <b>22</b>	4000	<b>WLMR140B</b>	14 W	1490 lm	○	1,1	<b>WLMR14DOB</b>

○ RAL9016

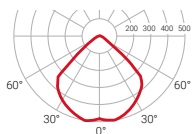

— C0-C180  
— C90-C270  $\eta=97\%$

DALI Compatible with  
**NormaLINK**

○ RAL9016

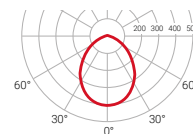

— C0-C180  
— C90-C270  $\eta=84\%$

DALI Compatible with  
**NormaLINK**

# Nahika Mini

Ceiling recessed mounted

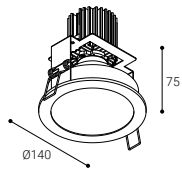

Ideal cut out  
**Ø125**  
Circular cut

60000 h.  
L70B10

CRI  
**>80**

90-96°

Efficiency (%)  
**97,6**

Photobiological safety

RG1\* **1** Low risk

\*Time under 3 h.

Go to page 443 to learn more



## © TRANSPARENT DIFFUSER

	K	REF.	W	LUMEN			REF. DALI
IP <b>54</b>	3000	<b>WLMR13TB</b>	14 W	1350 lm	○	1,1	<b>WLMR13DTB</b>
UGR <b>19</b>	4000	<b>WLMR14TB</b>	14 W	1490 lm	○	1,1	<b>WLMR14DTB</b>

○ RAL9016

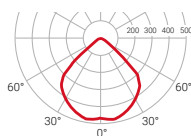

— C0-C180  
— C90-C270  $\eta=93\%$

Compatible with **NormaLINK**



# Nahika Micro

 **60000 h.**  
L70B10

CRI  
**>80**

 **32-51°**

Efficiency (%)  
**92,2**

Photobiological safety

**RG1\***  Low risk

\*Time under 3 h.

**Go to page 443 to learn more**



RAL9016



RAL9005



Nahika Micro  
Ø85 mm



# Nahika Micro Q

 **60000 h.**  
L70B10

CRI  
**>80**

 **32-51°**

Efficiency (%)  
**92,2**

Photobiological safety

**RG1\***  **1** Low risk

\*Time under 3 h.

**Go to page 443 to learn more**



RAL9016



RAL9005



Nahika Micro Q  
85x85 mm

# Nahika Micro

Ceiling recessed mounted



<b>60000 h.</b> L70B10	CRI <b>&gt;80</b>	<b>32-51°</b>	Efficiency (%) <b>92,2</b>
---------------------------	----------------------	---------------	-------------------------------

Photobiological safety

**RG1\*** **1** Low risk

\*Time under 3h.

Go to page 443 to learn more



## SWIVELLING / INTENSIVE OPTICS

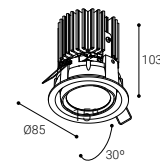

Ideal cut out  
**Ø78**  
Circular cut

	K	REF.	W	LUMEN			REF. DALI
IP <b>20</b>	3000	<b>WLPRB13B</b>	14 W	1350 lm	○	0,6	<b>WLPRB13DB</b>
UGR <b>19</b>	4000	<b>WLPRB14B</b>	14 W	1490 lm	○	0,6	<b>WLPRB14DB</b>

- RAL9016
- RAL9005 Replace "B" by "N" in the reference

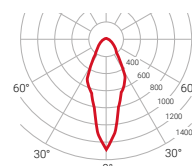

— C0-C180  
— C90-C270  $\eta=92\%$



# Nahika Micro

Ceiling recessed mounted



60000 h.  
L70B10

CRI  
>80

32-51°

Efficiency (%)  
92,2

Photobiological safety

RG1\* **1** Low risk

\*Time under 3 h.

Go to page 443 to learn more

## FIXED / INTENSIVE OPTICS

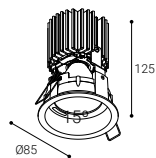

Ideal cut out  
**Ø78**  
Circular cut

	K	REF.	W	LUMEN			REF. DALI
IP 20	3000	<b>WLPRF13B</b>	14 W	1350 lm	○	0,5	<b>WLPRF13DB</b>
UGR 19	4000	<b>WLPRF14B</b>	14 W	1490 lm	○	0,5	<b>WLPRF14DB</b>

## FIXED / EXTENSIVE OPTICS

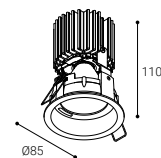

Ideal cut out  
**Ø78**  
Circular cut

	K	REF.	W	LUMEN			REF. DALI
IP 20	3000	<b>WLPRF13FB</b>	14 W	1350 lm	○	0,5	<b>WLPRF13FDB</b>
UGR 19	4000	<b>WLPRF14FB</b>	14 W	1490 lm	○	0,5	<b>WLPRB14FDB</b>

- RAL9016
- RAL9005 Replace "B" by "N" in the reference

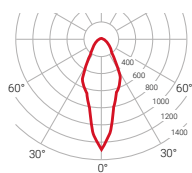

— C0-C180  $\eta=92\%$   
— C90-C270



- RAL9016
- RAL9005 Replace "B" by "N" in the reference

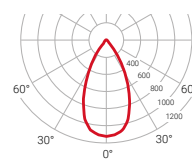

— C0-C180  $\eta=88\%$   
— C90-C270



# Nahika Micro Q

Ceiling recessed mounted



<b>60000 h.</b> L70B10	CRI <b>&gt;80</b>	<b>32-51°</b>	Efficiency (%) <b>92,2</b>
---------------------------	----------------------	---------------	-------------------------------

Photobiological safety

**RG1\*** **1** Low risk

\*Time under 3h.

Go to page 443 to learn more



## SWIVELLING / INTENSIVE OPTICS

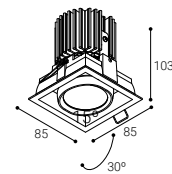

Ideal cut out  
**78x78**  
Square cut

	K	REF.	W	LUMEN			REF. DALI
IP <b>20</b>	3000	<b>WLPQB13B</b>	14 W	1350 lm		0,6	<b>WLPQB13DB</b>
UGR <b>19</b>	4000	<b>WLPQB14B</b>	14 W	1490 lm		0,6	<b>WLPQB14DB</b>

- RAL9016
- RAL9005 Replace "B" by "N" in the reference

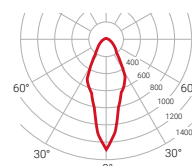

C0-C180  
C90-C270  $\eta=92\%$





# Nahika Micro Q

Ceiling recessed mounted



60000 h. L70B10 | CRI >80 | 32-51° | Efficiency (%) 92,2

Photobiological safety

RG1\* **1** Low risk

\*Time under 3 h.

Go to page 443 to learn more

## FIXED / INTENSIVE OPTICS

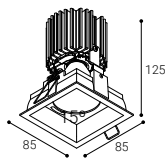

Ideal cut out  
**78x78**  
Square cut

## FIXED / EXTENSIVE OPTICS

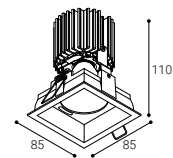

Ideal cut out  
**78x78**  
Square cut

	K	REF.	W	LUMEN			REF. DALI
IP 20	3000	<b>WLPQF13B</b>	14 W	1350 lm		0,6	<b>WLPQF13DB</b>
UGR 19	4000	<b>WLPQF14B</b>	14 W	1490 lm		0,6	<b>WLPQF14DB</b>

	K	REF.	W	LUMEN			REF. DALI
IP 20	3000	<b>WLPQF13FB</b>	14 W	1350 lm		0,6	<b>WLPQF13FDB</b>
UGR 19	4000	<b>WLPQF14FB</b>	14 W	1490 lm		0,6	<b>WLPQF14FDB</b>

- RAL9016
- RAL9005 Replace "B" by "N" in the reference

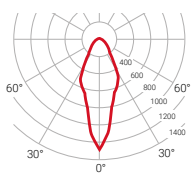

— C0-C180  $\eta=92\%$   
— C90-C270



- RAL9016
- RAL9005 Replace "B" by "N" in the reference

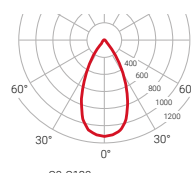

— C0-C180  $\eta=88\%$   
— C90-C270





# Polart

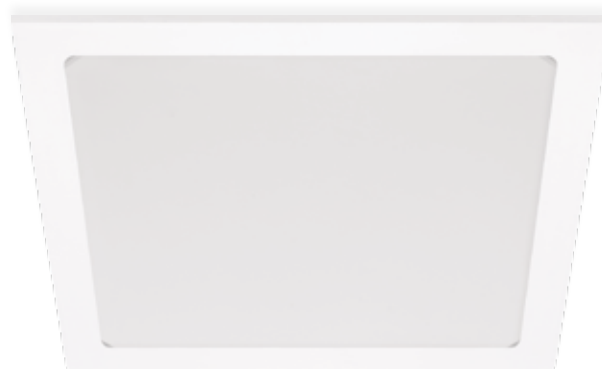

Polart is the new LED downlights family of Normalit, a line inspired by the contemporary visual style in order to offer new aesthetic possibilities thanks to a minimalistic and ecological illumination concept.

## Six versions

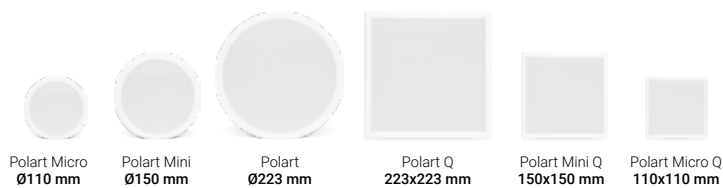

Ceiling recessed mounted

Surface ceiling mounted

Available in:

**SALUZ**<sup>®</sup>  
PLEASE CONTACT US

## POLART.

A downlight range with an attractive, sustainable design and multiple adaptation possibilities.

Polart  
Ø223 mm

Polart Mini  
Ø150 mm

Polart Micro  
Ø110 mm



Polart Q  
223x223 mm

Polart Mini Q  
150x150 mm

Polart Micro Q  
110x110 mm

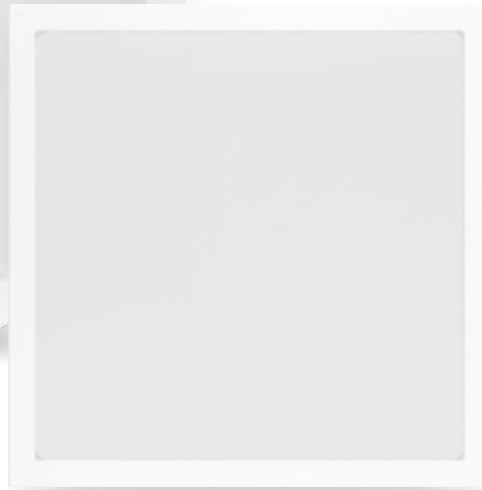

### Two installation modes

- Recessed installation
- Surface installation, with special accessories for each format and model of Polart.

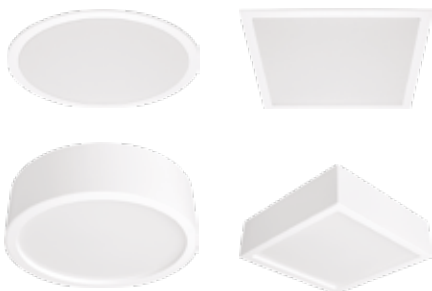

### New diffuser with two positions

Dual position diffuser:  
Flush or recessed.



### Three color temperatures

Available in:  
3000 K / 4000 K / 5000 K

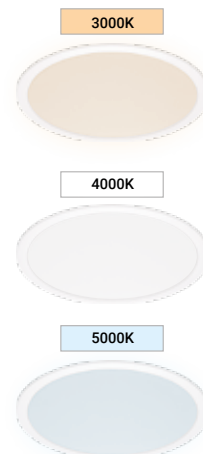

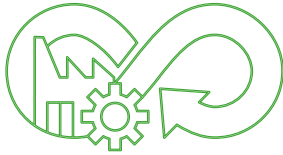

### Ecodesign and circular economy

The integral production of Polart in the Normagrup facilities allows us to have a sustainable, ecodesign and circular economy vision, guaranteeing the highest quality of all the components and the reduction of the ecological footprint in each process, from production to transport logistics.



Surface mounted using an accessory.



### Light and easy to install

A compact and easy to install format with digital control technology by DALI or push buttons.



**Color temperature selector**

- 3000K
- 4000K
- 5000K

Some models of Polart include an advanced system to integrate all the color temperatures of the range within the same product, with selection by means of a switch located at the back of the downlight.

### Polart

### Polart Mini

Installation	Ceiling recessed mounted Surface ceiling mounted	Ceiling recessed mounted Surface ceiling mounted
Diffuser	☉	☉
Light source	LED	LED
Photobiological safety	0	0
UGR	22	22
CRI	>80	>80
MacAdam ellipse	3	3
Beam angle range	114	114
Power range (W)	18	9
Colour temperature (°K)	3000   4000   5000	3000   4000   5000
Light range	2613-2790	1330-1420
Power factor	0,95	0,95
Efficiency (%)	74,1	72,6
Expectancy	72000 h L80B10	72000 h L80B10
DALI Option	✓	✓
Continuous operation 24h	✓	✓
IP	20-54	20-54
Class	II	II
Diameter range (mm)	204-218	132-145
Ideal cut out (mm)	210	137
Energy efficiency	C	C-B

☉ Opal diffuser

**CRI 360** | For other CRI values, please contact us.



Please request technical specifications of all the luminaires or visit our website.



### Polart Micro

Ceiling recessed mounted  
Surface ceiling mounted



LED

0

22

>80

3

114

4

3000 | 4000 | 5000

637-680

0,95

71,7

72000 h L80B10



20-54

II

98-106

100

C-B

### Polart Q

Ceiling recessed mounted  
Surface ceiling mounted



LED

0

22

>80

3

114

17

3000 | 4000 | 5000

2613-2790

0,95

79

72000 h L80B10



20-54

II

207-218

210

C

### Polart Mini Q

Ceiling recessed mounted  
Surface ceiling mounted



LED

0

22

>80

3

114

9

3000 | 4000 | 5000

1330-1420

0,95

67,8

72000 h L80B10



20-54

II

134-145

137

C-B

### Polart Micro Q

Ceiling recessed mounted  
Surface ceiling mounted



LED

0

22

>80

3

114

4

3000 | 4000 | 5000

637-680

0,95

71,4

72000 h L80B10



20-54

II

98-106

100

C-B





# Polart

Ceiling recessed mounted

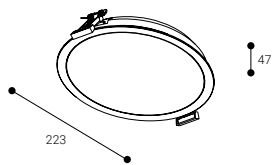

Minimum ceiling installation height  
**97**

Diameter range  
**Ø204-218**  
Ideal cut out  
**Ø210**  
Circular cut

**72000 h.**  
L80B10

CRI  
**>80**

**114°**

Efficiency (%)  
**74,1**

Photobiological safety

**RG0** **0** Risk free

Go to page 443 to learn more



## OPAL DIFFUSER

	K	REF.	W	LUMEN			REF. DALI
IP <b>20-54</b>	3000	<b>P023B</b>	18 W	2613 lm	○ 0,5		<b>P023DB</b>
UGR <b>22</b>	4000	<b>P024B</b>	18 W	2750 lm	○ 0,5		<b>P024DB</b>
	5000	<b>P025B</b>	18 W	2790 lm	○ 0,5		<b>P025DB</b>

## Color temperature selector

	K	REF.	W	LUMEN			REF. DALI
IP <b>20-54</b>	3000 4000 5000	<b>P02XB</b>	18 W	2750 lm	○ 0,5		<b>P02XDB</b>
UGR <b>22</b>							

## RAL9016

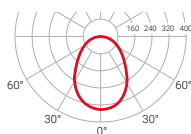

— C0-C180  
— C90-C270

**DALI** Compatible with **NormaLINK**

# Polart Mini

Ceiling recessed mounted

LED CE RoHS

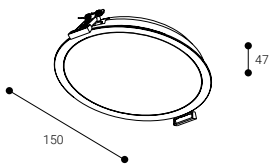

Minimum ceiling installation height  
**97**

Diameter range  
**Ø132-145**  
Ideal cut out  
**Ø137**  
Circular cut

**72000 h.**  
L80B10

CRI  
**>80**

**114°**

Efficiency (%)  
**72,6**

Photobiological safety

**RG0** **0** Risk free

Go to page 443 to learn more



## OPAL DIFFUSER

	K	REF.	W	LUMEN			REF. DALI
IP 20-54	3000	<b>PM13B</b>	9 W	1330 lm		0,3	<b>PM13DB</b>
UGR 22	4000	<b>PM14B</b>	9 W	1400 lm		0,3	<b>PM14DB</b>
	5000	<b>PM15B</b>	9 W	1420 lm		0,3	<b>PM15DB</b>

## Color temperature selector

	K	REF.	W	LUMEN			REF. DALI
IP 20-54		<b>PM1XB</b>	9 W	1400 lm		0,3	<b>PM1XDB</b>
UGR 22							

RAL9016

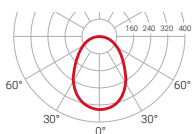

C0-C180  
 C90-C270

**DALI** Compatible with **NormaLINK**

# Polart Micro

Ceiling recessed mounted

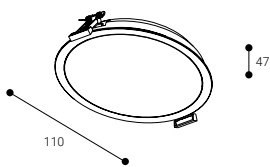

Minimum ceiling installation height  
**97**

Diameter range  
**Ø98-106**  
Ideal cut out  
**Ø100**  
Circular cut

**72000 h.**  
L80B10

CRI  
**>80**

**114°**

Efficiency (%)  
**71,7**

Photobiological safety

**RG0** **0** Risk free

Go to page 443 to learn more



## OPAL DIFFUSER

	K	REF.	W	LUMEN			REF. DALI
IP <b>20-54</b>	3000	<b>PP03B</b>	4 W	637 lm		0,17	<b>PP03DB</b>
UGR <b>22</b>	4000	<b>PP04B</b>	4 W	670 lm		0,17	<b>PP04DB</b>
	5000	<b>PP05B</b>	4 W	680 lm		0,17	<b>PP05DB</b>

## Color temperature selector

	K	REF.	W	LUMEN			REF. DALI
IP <b>20-54</b>		<b>PP0XB</b>	4 W	670 lm		0,17	<b>PP0XDB</b>
UGR <b>22</b>							

RAL9016

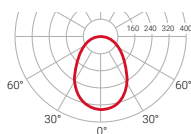

C0-C180  
 C90-C270



# Polart Q

Ceiling recessed mounted

LED CE RoHS

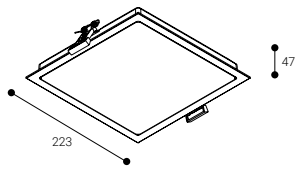

Minimum ceiling installation height  
**97**

Diameter range  
**Ø207-218**  
Ideal cut out  
**Ø210**  
Circular cut

72000 h.  
L80B10

CRI  
**>80**

114°

Efficiency (%)  
**79**

Photobiological safety

RG0 **0** Risk free

Go to page 443 to learn more

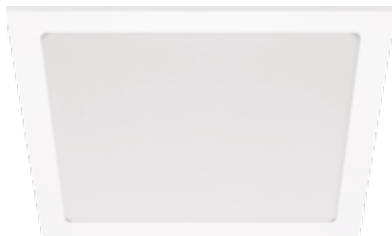

## OPAL DIFFUSER

	K	REF.	W	LUMEN			REF. DALI
IP 20-54	3000	<b>POQ23B</b>	17 W	2613 lm	○	0,5	<b>POQ23DB</b>
UGR 22	4000	<b>POQ24B</b>	17 W	2750 lm	○	0,5	<b>POQ24DB</b>
	5000	<b>POQ25B</b>	17 W	2790 lm	○	0,5	<b>POQ25DB</b>

## Color temperature selector

	K	REF.	W	LUMEN			REF. DALI
IP 20-54	3000 4000 5000	<b>POQ2XB</b>	17 W	2750 lm	○	0,5	<b>POQ2XDB</b>
UGR 22							

○ RAL9016

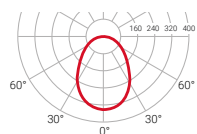

— C0-C180  
— C90-C270

DALI Compatible with **NormaLINK**

# Polart Mini Q

Ceiling recessed mounted

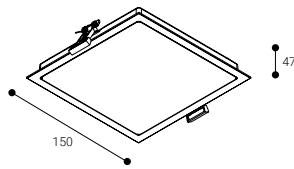

Minimum ceiling installation height  
**97**

Diameter range  
**Ø134-145**  
Ideal cut out  
**Ø137**  
Circular cut

**72000 h.**  
L80B10

CRI  
**>80**

**114°**

Efficiency (%)  
**67,8**

Photobiological safety

**RG0** **0** Risk free

Go to page 443 to learn more

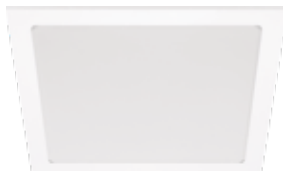

## OPAL DIFFUSER

	K	REF.	W	LUMEN			REF. DALI
IP <b>20-54</b>	3000	<b>PMQ13B</b>	9 W	1330 lm		0,3	<b>PMQ13DB</b>
UGR <b>22</b>	4000	<b>PMQ14B</b>	9 W	1400 lm		0,3	<b>PMQ14DB</b>
	5000	<b>PMQ15B</b>	9 W	1420 lm		0,3	<b>PMQ15DB</b>

## Color temperature selector

	K	REF.	W	LUMEN			REF. DALI
IP <b>20-54</b>		<b>PMQ1XB</b>	9 W	1400 lm		0,3	<b>PMQ1XDB</b>
UGR <b>22</b>							

RAL9016

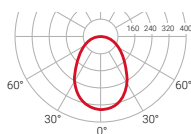

C0-C180  
 C90-C270

Compatible with **NormaLINK**

# Polart Micro Q

Ceiling recessed mounted

LED CE RoHS

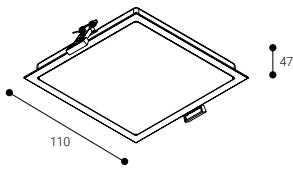

Minimum ceiling installation height  
**97**

Diameter range  
**Ø98-106**  
Ideal cut out  
**Ø100**  
Circular cut

**72000 h.**  
L80B10

CRI  
**>80**

**114°**

Efficiency (%)  
**71,4**

Photobiological safety

**RG0** **0** Risk free

Go to page 443 to learn more



## OPAL DIFFUSER

	K	REF.	W	LUMEN			REF. DALI
IP 20-54	3000	PPQ03B	4 W	637 lm	○	0,17	PPQ03DB
UGR 22	4000	PPQ04B	4 W	670 lm	○	0,17	PPQ04DB
	5000	PPQ05B	4 W	680 lm	○	0,17	PPQ05DB

## Color temperature selector

	K	REF.	W	LUMEN			REF. DALI
IP 20-54	3000 4000 5000	-	4 W	670 lm	○	0,17	PPQ0XDB
UGR 22							

○ RAL9016

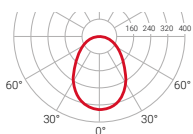

— C0-C180  
— C90-C270

**DALI** Compatible with **NormaLINK**

# Polart

ACCESSORIES

**Surface ceiling mounted accessory**

<b>POSB</b>	Surface Polart
<b>PMSB</b>	Surface Polart Mini
<b>PPSB</b>	Surface Polart Micro
<b>POQSB</b>	Surface Polart Q
<b>PMQSB</b>	Surface Polart Mini Q
<b>PPQSB</b>	Surface Polart Micro Q

 COMPATIBLE ACCESSORIES ONLY  
WITH STANDARD VERSION

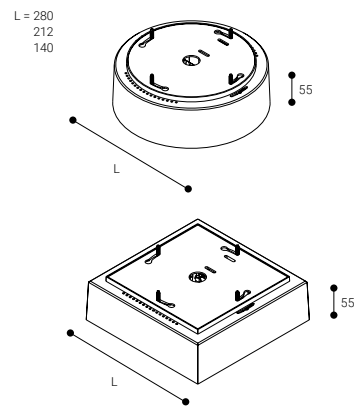

# Kuiper

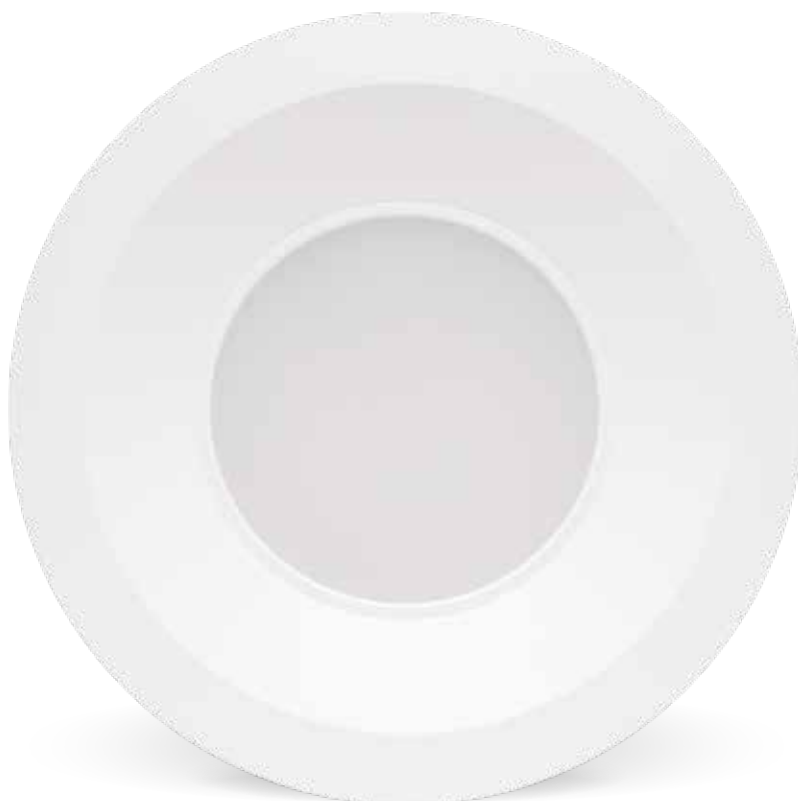

KUIPER is a compact recessed downlight with a diameter of 210 mm and a height of 57 mm.

It has an aluminum heat sink, opal prismatic polycarbonate diffuser and ABS reflector. It is available in Standard and DALI versions.



**72000 h.**  
L70B10

CRI  
**>80**

△  
**97°**

Efficiency (%)  
**9,7**

Photobiological safety

RG0 **0** Risk free

\*Time under 3h.

**Go to page 443 to learn more**

Ceiling recessed mounted





Cut out 180-205 mm

To replace standard 2 x 26w  
downlights



## Kuiper

Installation	Ceiling recessed mounted
Diffuser	●
Light source	LED
Photobiological safety	0
UGR	22
CRI	>80
MacAdam ellipse	3
Beam angle range	97
Power range (W)	13
Colour temperature (°K)	3000   4000   5000
Light range	1750-1880
Power factor	0,97
Efficiency (%)	69,7
Expectancy	72000 h L70B10
DALI Option	✓
Continuous operation 24h	✓
IP	20-54
Class	II
Ideal cut out (mm)	180-205
Energy efficiency	C   D

● Opal diffuser

# Kuiper

Ceiling recessed mounted

LED CE RoHS

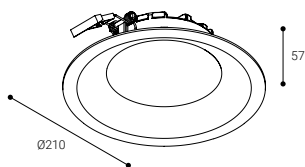

72000 h.  
L70B10

CRI  
>80

97°

Efficiency (%)  
69,7

Photobiological safety

RG0 0 Risk free

\*Time under 3 h.

Go to page 443 to learn more



## OPAL DIFFUSER

	K	REF.	W	LUMEN	Ø	h	IP	UGR	DALI	REF. DALI
IP 20-54	3000	<b>K23B</b>	13 W	1750 lm	Ø	0,3	20	18	DALI	<b>K23DB</b>
UGR 22	4000	<b>K24B</b>	13 W	1850 lm	Ø	0,3	20	18	DALI	<b>K24DB</b>
	5000	<b>K25B</b>	13 W	1880 lm	Ø	0,3	20	18	DALI	<b>K25DB</b>

○ RAL9016

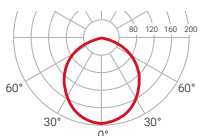

— C0-C180  
— C90-C270  $\eta=69,7\%$

DALI Compatible with NormaLINK





# Hat



Hat is the latest generation of LED Downlights. With only 44 mm height and a performance of 75% it can reach up to 2.435 lumen output.

HAT is a compact downlight of high efficiency, with DALI version available and EH1 54.000h L70B10 / EH2 72.000h L70B10 life expectancy.

## Six versions

Circular cut, two of them with square frame diameters



Ceiling recessed mounted



RAL9016



RAL7001



RAL9005

Now  
also available  
in 5000°K temperature

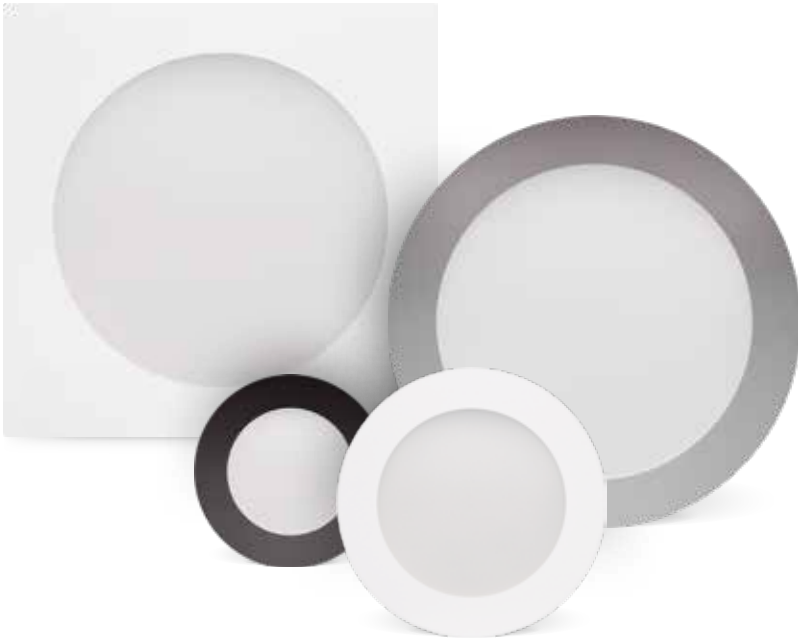

NUMBER OF FITTINGS NEEDED  
IN A STANDARD INSTALLATION

**EH24**

	200 lx	300 lx	500 lx
50 m <sup>2</sup>	6	8	14
100 m <sup>2</sup>	9	16	25
150 m <sup>2</sup>	16	20	36
200 m <sup>2</sup>	20	30	46

Height used for the calculation: 2,8 m

Version  
**SALUZ®**  
page 117

**CRI 360** | For other CRI values,  
please contact us.

**Please request technical specifications of all the luminaires or visit our website.**

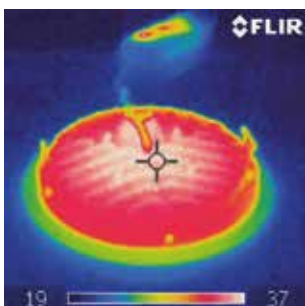

	Hat	Hat HR
Installation	Ceiling recessed mounted	Ceiling recessed mounted
Diffuser	⊙ ⊙*	⊙ ⊙*
Light source	LED	LED
Photobiological safety	0	0
UGR	22	21
CRI	>80	>80
MacAdam ellipse	3	3
Beam angle range	84	84
Power range (W)	13-20,5	13-20,5
Colour temperature (°K)	3000   4000   5000   6000	2700   3000   4000   5000   5600   6000   6500
Light range	1500-2435	1500-2600
Power factor	0,95	0,95
Efficiency (%)	75,1	75,1
Expectancy	54000   72000 h L70B10	54000-72000 h L70B10
DALI Option	✓	✓
Continuous operation 24h	✓	✓
IP	20-54	20-54
Class	II	II
Ideal cut out (mm)	210	215
Energy efficiency	D   E	C   D   E

⊙ Microprismatic diffuser

⊙\* Opal diffuser on order



Compact

44 mm

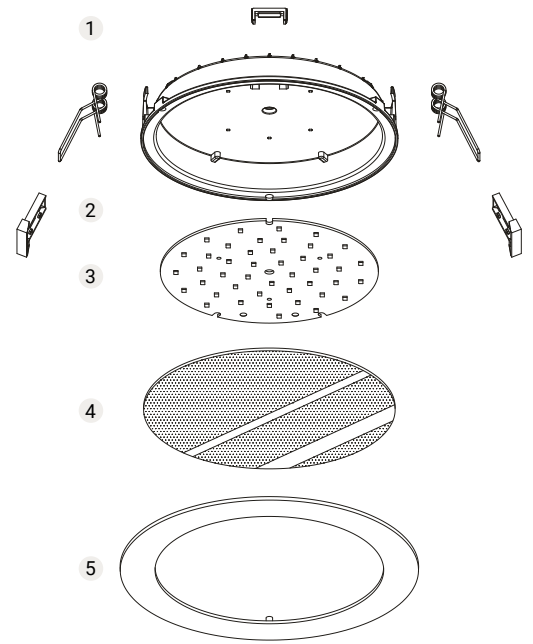

- 1 Aluminium heat sink
- 2 Fixing clamps
- 3 SMD LED board
- 4 Microprismatic diffuser
- 5 Customizable aluminium ring

### Hat Q

Ceiling recessed mounted



LED

0

19

>80

3

84

20,5

3000 | 4000 | 5000 | 6000

2300-2435

0,95

75,1

72000 h L70B10

✓

✓

20-54

II

210

DIE

### Hat Mini

Ceiling recessed mounted



LED

0

22

>80

3

85

10,9

3000 | 4000 | 5000 | 6000

1400-1520

0,98

69,2

72000 h L70B10

✓

✓

20-54

II

135

CID

### Hat Mini Q

Ceiling recessed mounted



LED

0

22

>80

3

85

10,9

3000 | 4000 | 5000 | 6000

1400-1520

0,98

69,2

72000 h L70B10

✓

✓

20-54

II

135

CID

### Hat Micro

Ceiling recessed mounted



LED

0

22

>80

3

84

4,8

3000 | 4000 | 5000 | 6000

460-510

0,95

75,1

72000 h L70B10

-

✓

20-54

I

100

E

Recessed downlights





# Hat

Ceiling recessed mounted

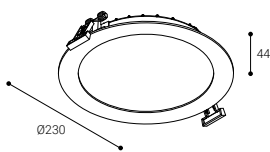

Minimum ceiling installation height  
**94**

Diameter range  
**Ø200-225**  
Ideal cut out  
**Ø210**  
Circular cut

EH1: **54000 h.**  
EH2: **72000 h.**  
L70B10

CRI  
**>80**

Beam angle  
**84°**

Efficiency (%)  
**75,1**

Photobiological safety

RG0 **0** Risk free

\*Time under 3 h.

Go to page 443 to learn more



## © MICROPRISMATIC DIFFUSER

	K	REF.	W	LUMEN			REF. DALI
IP 20-54	3000	<b>EH13B</b>	13 W	1500 lm	○	0,8	18 <b>EH13DB</b>
		<b>EH23B</b>	20,5 W	2300 lm	○	0,8	18 <b>EH23DB</b>
UGR 22	4000	<b>EH14B</b>	13 W	1600 lm	○	0,8	18 <b>EH14DB</b>
		<b>EH24B</b>	20,5 W	2400 lm	○	0,8	18 <b>EH24DB</b>
	5000	<b>EH15B</b>	13 W	1625 lm	○	0,8	18 <b>EH15DB</b>
		<b>EH25B</b>	20,5 W	2430 lm	○	0,8	18 <b>EH25DB</b>
6000	<b>EH16B</b>	13 W	1625 lm	○	0,8	18 <b>EH16DB</b>	
	<b>EH26B</b>	20,5 W	2435 lm	○	0,8	18 <b>EH26DB</b>	

- RAL9016
- RAL7001 Replace "B" by "G" in the reference
- RAL9005 Replace "B" by "N" in the reference

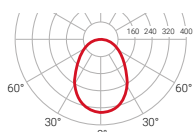

— C0-C180  
— C90-C270  $\eta=75\%$

Compatible with **NormaLINK**



# Hat HR

## Less glare

As a new product within the HAT range, HAT HR is a revision of the popular Normalit downlight. A new design that keeps the original essence and with a lower glare.

Available in:

[saLuz®](#)



# Hat HR

Ceiling recessed mounted

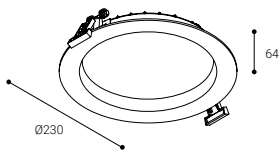

Minimum ceiling installation height  
**94**

Diameter range  
**Ø210-225**  
Ideal cut out  
**Ø215**  
Circular cut

EH1: **54000 h.**  
EH2: **72000 h.**  
L70B10

CRI  
**>80**

Beam angle  
**84°**

Efficiency (%)  
**75,1**

Photobiological safety

RG0 **0** Risk free

\*Time under 3 h.

Go to page 443 to learn more



## © MICROPRISMATIC DIFFUSER

	K	REF.	W	LUMEN			REF. DALI
IP 20-54	3000	EHI13B	13 W	1500 lm	○	0,8	EHI13DB
		EHI23B	20,5 W	2300 lm	○	0,8	EHI23DB
UGR 21	4000	EHI14B	13 W	1600 lm	○	0,8	EHI14DB
		EHI24B	20,5 W	2400 lm	○	0,8	EHI24DB
	5000	EHI15B	13 W	1625 lm	○	0,8	EHI15DB
		EHI25B	20,5 W	2430 lm	○	0,8	EHI25DB
6000	EHI16B	13 W	1625 lm	○	0,8	EHI16DB	
	EHI26B	20,5 W	2435 lm	○	0,8	EHI26DB	

- RAL9016
- RAL7001 Replace "B" by "G" in the reference
- RAL9005 Replace "B" by "N" in the reference

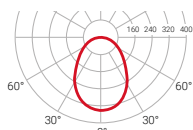

— C0-C180  $\eta=75\%$   
— C90-C270

Compatible with **NormaLINK**



# Hat HR saLUZ®



SaLuz® Video  
and more information

Ceiling recessed mounted

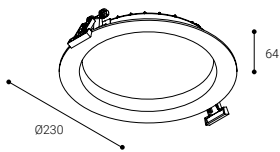

Minimum ceiling installation height  
**94**

Diameter range  
**Ø220-225**  
Ideal cut out  
**Ø215**  
Circular cut

**72000 h.**  
L70B10

CRI  
**>80**

**84°**

Efficiency (%)  
**75,1**

Photobiological safety

**RG0** **0** Risk free

\*Time under 3 h.

Go to page 443 to learn more



saLUZ®

◎ MICROPRISMATIC DIFFUSER

	K	REF.		W	LUMEN		
IP <b>20-54</b>	2700-5600	<b>EHI2ZB</b>	●	17 W	2600 lm	○	0,8
UGR <b>21</b>	2700-6500	<b>EHI2TWB</b>	●	17 W	2600 lm	○	0,8

● saLUZ® **Self-contained**

Once the luminaire has been connected to mains, it automatically modifies the intensity and the tone of the light all over the day.

● saLUZ® **Tunable white**

COMPATIBLE WITH NORMALINK

This version makes it possible to modify circadian cycles from Normalink in remote, and also to adapt them to the specific needs of the project.

- RAL9016
- RAL7001 Replace "B" by "G" in the reference
- RAL9005 Replace "B" by "N" in the reference

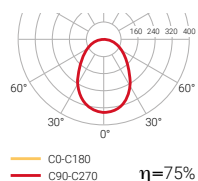



# Hat Q

Ceiling recessed mounted

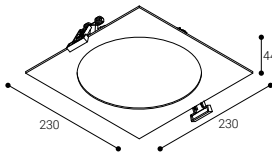

Minimum ceiling installation height  
**94**

Diameter range  
**Ø200-225**  
Ideal cut out  
**Ø210**  
Circular cut

**72000 h.**  
L70B10

CRI  
**>80**

**84°**

Efficiency (%)  
**75,1**

Photobiological safety

**RG0** **0** Risk free

\*Time under 3 h.

Go to page 443 to learn more



## © MICROPRISMATIC DIFFUSER

	K	REF.	W	LUMEN			REF. DALI
IP <b>20-54</b>	3000	<b>EHQ23B</b>	20,5 W	2300 lm		0,8	<b>EHQ23DB</b>
UGR <b>22</b>	4000	<b>EHQ24B</b>	20,5 W	2400 lm		0,8	<b>EHQ24DB</b>
	5000	<b>EHQ25B</b>	20,5 W	2430 lm		0,8	<b>EHQ25DB</b>
	6000	<b>EHQ26B</b>	20,5 W	2435 lm		0,8	<b>EHQ26DB</b>

- RAL9016
- RAL7001 Replace "B" by "G" in the reference
- RAL9005 Replace "B" by "N" in the reference

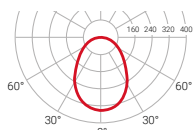

C0-C180  
 C90-C270  $\eta=75\%$

Compatible with **NormaLINK**

# Hat Mini

Ceiling recessed mounted

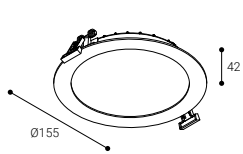

Minimum ceiling installation height  
**94**

Diameter range  
**Ø125-150**  
Ideal cut out  
**Ø135**  
Circular cut

**72000 h.**  
L70B10

CRI  
**>80**

**85°**

Efficiency (%)  
**69,2**

Photobiological safety

RG0 **0** Risk free

Go to page 443 to learn more



## © MICROPRISMATIC DIFFUSER

	K	REF.	W	LUMEN			REF. DALI
IP <b>20-54</b>	3000	<b>EHM13B</b>	10,9 W	1400 lm		0,3	<b>EHM13DB</b>
UGR <b>22</b>	4000	<b>EHM14B</b>	10,9 W	1500 lm		0,3	<b>EHM14DB</b>
	5000	<b>EHM15B</b>	10,9 W	1520 lm		0,3	<b>EHM15DB</b>
	6000	<b>EHM16B</b>	10,9 W	1520 lm		0,5	<b>EHM16DB</b>

- RAL9016
- RAL7001 Replace "B" by "G" in the reference
- RAL9005 Replace "B" by "N" in the reference

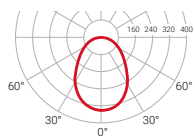

CO-C180  
C90-C270  $\eta=75\%$

**DALI** Compatible with **NormaLINK**



# Hat Mini Q

Ceiling recessed mounted

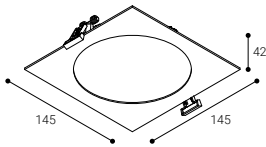

Minimum ceiling installation height  
**94**

Diameter range  
**Ø125-140**  
Ideal cut out  
**Ø135**  
Circular cut

**72000 h.**  
L70B10

CRI  
**>80**

**85°**

Efficiency (%)  
**69,2**

Photobiological safety

**RG0** **0** Risk free

\*Time under 3 h.

Go to page 443 to learn more



## © MICROPRISMATIC DIFFUSER

	K	REF.	W	LUMEN			REF. DALI
IP <b>20-54</b>	3000	<b>EHMQ13B</b>	10,9 W	1400 lm	○	0,3	<b>EHMQ13DB</b>
UGR <b>22</b>	4000	<b>EHMQ14B</b>	10,9 W	1500 lm	○	0,3	<b>EHMQ14DB</b>
	5000	<b>EHMQ15B</b>	10,9 W	1520 lm	○	0,3	<b>EHMQ15DB</b>
	6000	<b>EHMQ16B</b>	10,9 W	1520 lm	○	0,3	<b>EHMQ16DB</b>

- RAL9016
- RAL7001 Replace "B" by "G" in the reference
- RAL9005 Replace "B" by "N" in the reference

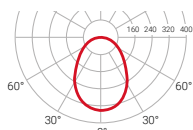

— C0-C180  
— C90-C270  $\eta=75\%$

Compatible with  
**NormaLINK**

# Hat Micro

Ceiling recessed mounted

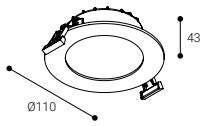
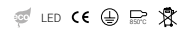

Diameter range  
**Ø92-105**

Ideal cut out  
**Ø100**

Circular cut

**72000 h.**  
L70B10

CRI  
**>80**

**84°**

Efficiency (%)  
**75,1**

Photobiological safety

RG0 **0** Risk free

Go to page 443 to learn more



## © MICROPRISMATIC DIFFUSER

	K	REF.	W	LUMEN			REF. DALI
IP <b>20-54</b>	3000	<b>EHP03B</b>	4,8 W	460 lm	○	0,5	—
UGR <b>22</b>	4000	<b>EHP04B</b>	4,8 W	500 lm	○	0,5	—
	5000	<b>EHP05B</b>	4,8 W	510 lm	○	0,5	—
	6000	<b>EHP06B</b>	4,8 W	510 lm	○	0,5	—

- RAL9016
- RAL7001 Replace "B" by "G" in the reference
- RAL9005 Replace "B" by "N" in the reference

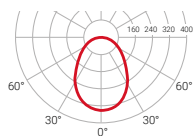

— C0-C180  
— C90-C270  $\eta=75\%$







# IR



IR is a range of recessed downlights with a simple, attractive and functional design, with round shape.  
DALI regulation available.

---

©

 <b>60000 h.</b> L70B10	CRI <b>&gt;80</b>	 <b>60-61°</b>	Efficiency (%) <b>91,9</b>
---------------------------------------------------------------------------------------------------------------	----------------------	---------------------------------------------------------------------------------------------------	-------------------------------

Photobiological safety

**RG1\***  Low risk

\*Time under 3 h.

**Go to page 443 to learn more**

Ceiling recessed mounted



## Flexibility with different diameters

As an accessory, IR offers an additional recession frame with a different diameter, which makes it a very flexible solution when working with different hole diameters.



IR  
Ø79 mm

Accessory  
Ø85 mm

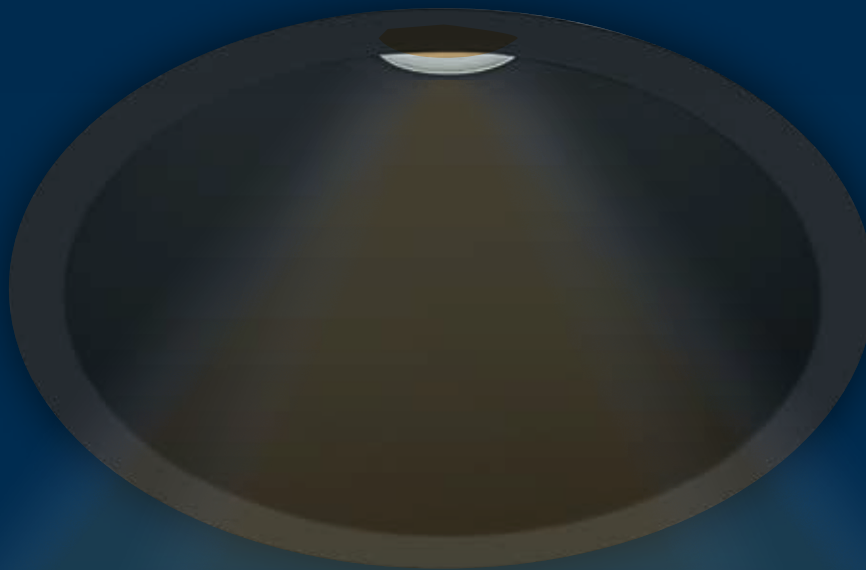

To replace Dichroic and LED lamps.

24h continuous operation guaranteed.

**CRI 360** | For other CRI values, please contact us.



RAL9016



RAL9005

## IR

Installation	Ceiling recessed mounted
Diffuser	①
Light source	LED
Photobiological safety	1
UGR	19
CRI	>80
MacAdam ellipse	3
Beam angle range	60-61
Power range (W)	5,8
Colour temperature (°K)	3000   4000
Light range	670-700
Power factor	0,94
Efficiency (%)	91,9
Expectancy	60000 h L70B10
DALI Option	✓
Continuous operation 24h	✓
IP	20-54
Class	II
Ideal cut out (mm)	79
Energy efficiency	D

① Transparent diffuser

# IR

Ceiling recessed mounted

LED CE RoHS

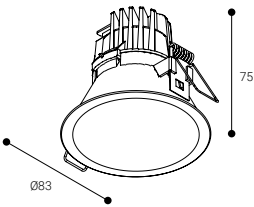

Ideal cut out  
**Ø79**  
Circular cut

60000 h.  
L70B10

CRI  
**>80**

60-61°

Efficiency (%)  
**91,9**

Photobiological safety

RG1\* **1** Low risk

\*Time under 3 h.

Go to page 443 to learn more



## WITHOUT PHASE CUT REGULATION

	K	REF.	W	LUMEN				REF. DALI
IP 20-54	3000	<b>IR03STB</b>	5,8 W	670 lm	○	0,1	20	-
UGR 19	4000	<b>IR04STB</b>	5,8 W	700 lm	○	0,1	20	-

## REGULATION BY PHASE CUT

	K	REF.	W	LUMEN				REF. DALI
IP 20-54	3000	<b>IR03TB</b>	5,8 W	670 lm	○	0,1	20	<b>IR03DTB</b>
UGR 19	4000	<b>IR04TB</b>	5,8 W	700 lm	○	0,1	20	<b>IR04DTB</b>

- RAL9016
- RAL9005 Replace "B" by "N" in the reference

Transparent diffuser

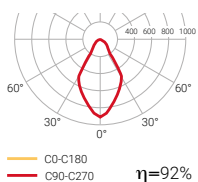

**DALI** Compatible with **NormaliNK**

## ACCESSORIES

### Adapter Ø85

- IRAB
- IRAN

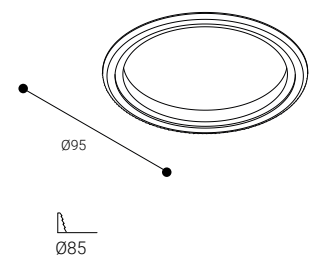



# IR + IQ

The perfect combination

Achieve natural and original lighting with the fusion of the IR and IQ downlight ranges. Combine circular and square shapes to create a harmonious and minimalist composition with light as the invisible protagonist of the space.



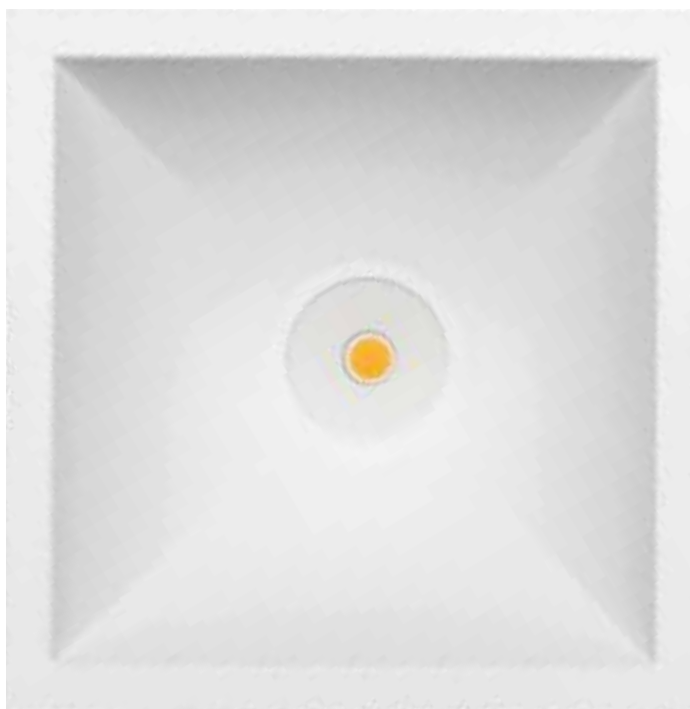

# IQ



IQ is a range of recessed downlights with a simple, attractive and functional design, with square shape. DALI regulation available.

---

©

 <b>60000 h.</b> L70B10	CRI <b>&gt;80</b>	 <b>60-63°</b>	Efficiency (%) <b>91,3</b>
---------------------------------------------------------------------------------------------------------------	----------------------	---------------------------------------------------------------------------------------------------	-------------------------------

Photobiological safety

**RG1\***  **1** Low risk

\*Time under 3 h.

**Go to page 443 to learn more**

Ceiling recessed mounted

---



## Flexibility with different diameters

As an accessory, IQ offers an additional recession frame with a different diameter, which makes it a very flexible solution when working with different hole diameters.

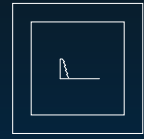

IQ  
79x79 mm

Accessory  
85x85 mm



To replace dichroic and LED lamps.

24h continuous operation guaranteed.

**CRI 360** | For other CRI values,  
please contact us.



RAL9016



RAL9005

## IQ

Installation	Ceiling recessed mounted
Diffuser	①
Light source	LED
Photobiological safety	1
UGR	19
CRI	>80
MacAdam ellipse	3
Beam angle range	60-63
Power range (W)	5,8
Colour temperature (°K)	3000   4000
Light range	670-700
Power factor	0,94
Efficiency (%)	91,3
Expectancy	60000 h L70B10
DALI Option	✓
Continuous operation 24h	✓
IP	20-54
Class	II
Ideal cut out (mm)	79x79
Energy efficiency	D

① Transparent diffuser

# IQ

Ceiling recessed mounted

LED CE RoHS

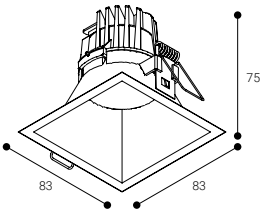

Ideal cut out  
**79x79**  
Square cut

60000 h.  
L70B10

CRI  
**>80**

60-63°

Efficiency (%)  
**91,3**

Photobiological safety

RG1\* **1** Low risk

\*Time under 3 h.

Go to page 443 to learn more



## WITHOUT PHASE CUT REGULATION

	K	REF.	W	LUMEN				REF. DALI
IP 20-54	3000	<b>IQ03STB</b>	5,8 W	670 lm	○	0,1	20	—
UGR 19	4000	<b>IQ04STB</b>	5,8 W	700 lm	○	0,1	20	—

## REGULATION BY PHASE CUT

	K	REF.	W	LUMEN				REF. DALI
IP 20-54	3000	<b>IQ03TB</b>	5,8 W	670 lm	○	0,1	20	<b>IQ03DTB</b>
UGR 19	4000	<b>IQ04TB</b>	5,8 W	700 lm	○	0,1	20	<b>IQ04DTB</b>

○ RAL9016

● RAL9005 Replace "B" by "N" in the reference

Transparent diffuser

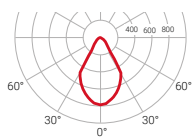

— C0-C180  
— C90-C270  $\eta=91\%$

**DALI** Compatible with **NormaLINK**

## ACCESSORIES

### Adapter 85X85

○ IQAB

● IQAN

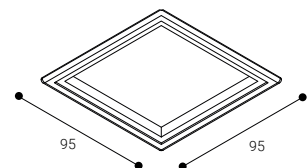

85X85

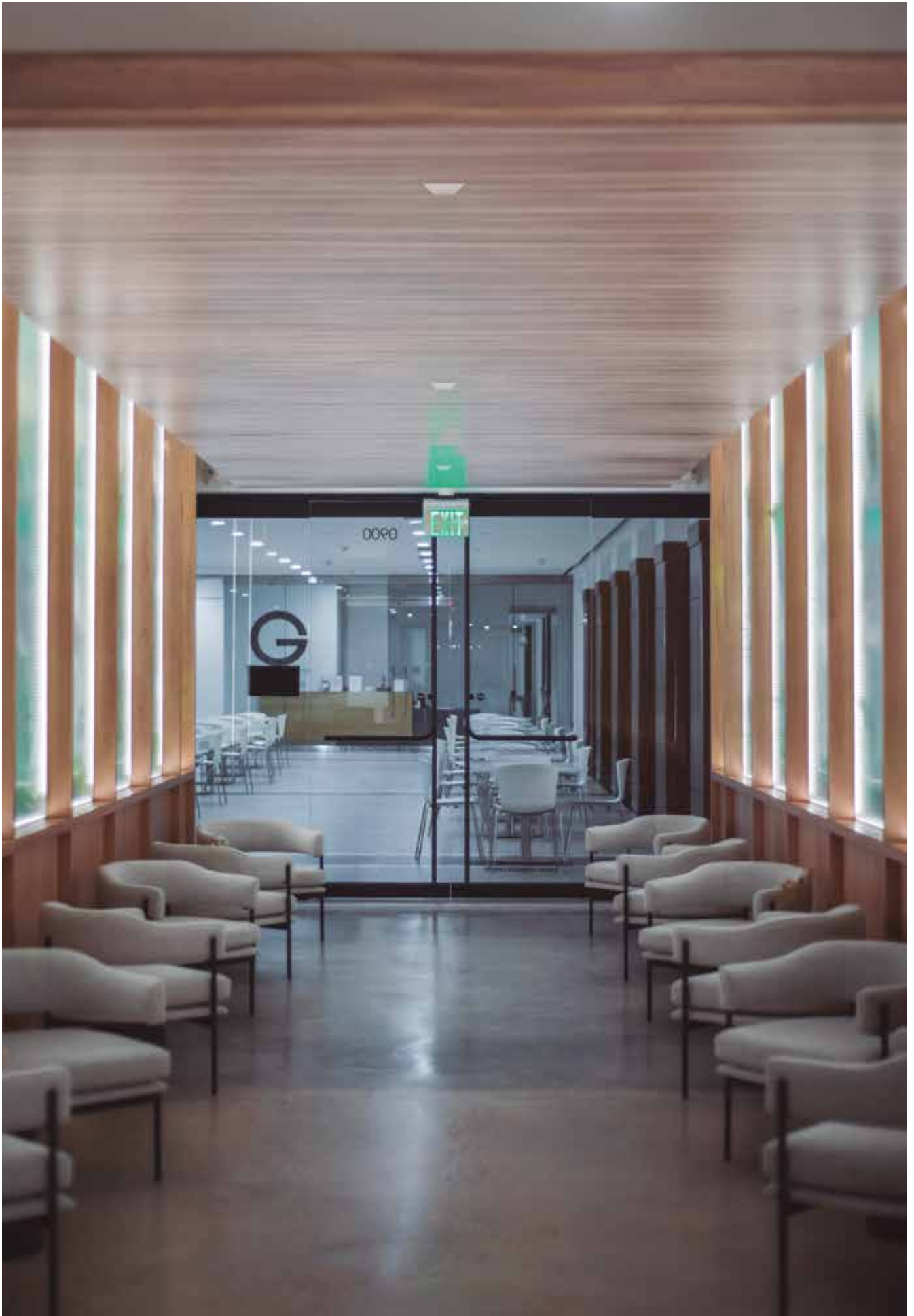

# Tiny



TINY is a small-sized high performance swivelling downlight.

Available with white, grey or black ring.

 **60000 h.**  
L70B10

CRI  
**>80**

 **66°**

Efficiency (%)  
**87,3**

Photobiological safety

**RG1\***  Low risk

\*Time under 3 h.

**Go to page 443 to learn more**

Ceiling recessed mounted

Can be managed by phase cut  
(only fittings not Dali compatible)



To replace dichroic and LED lamps.

24h continuous operation guaranteed.



For other CRI values,  
please contact us.



RAL9016



RAL7001



RAL9005

## Tiny

Installation	Ceiling recessed mounted
Diffuser	☉
Light source	LED
Photobiological safety	1
UGR	19
CRI	>80
MacAdam ellipse	3
Beam angle range	66
Power range (W)	5,8
Colour temperature (°K)	3000   4000
Light range	670-700
Power factor	0,94
Efficiency (%)	87,3
Expectancy	60000 h L70B10
DALI Option	✓
Continuous operation 24h	✓
IP	20
Class	II
Ideal cut out (mm)	70
Energy efficiency	D

☉ Without diffuser

# Tiny

Ceiling recessed mounted

LED CE RoHS

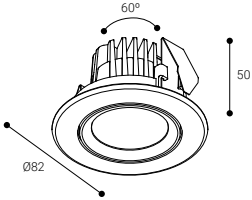

Minimum ceiling installation height  
**94**

Ideal cut out  
**Ø70**  
Circular cut

60000 h.  
L70B10

CRI  
**>80**

66°

Efficiency (%)  
**87,3**

Photobiological safety

RG1\* **1** Low risk

\*Time under 3 h.

Go to page 443 to learn more



## WITHOUT PHASE CUT REGULATION

	K	REF.	W	LUMEN	Beam	THD	CF	REF. DALI
IP 20	3000	<b>TI03SB</b>	5,8 W	670 lm	○	0,1	10	—
UGR 19	4000	<b>TI04SB</b>	5,8 W	700 lm	○	0,1	10	—

## REGULATION BY PHASE CUT

	K	REF.	W	LUMEN	Beam	THD	CF	DALI	REF. DALI
IP 20	3000	<b>TI03B</b>	5,8 W	670 lm	○	0,1	10	1	<b>TI03DB</b>
UGR 19	4000	<b>TI04B</b>	5,8 W	700 lm	○	0,1	10	1	<b>TI04DB</b>

- RAL9016
- RAL7001 Replace "B" by "G" in the reference
- RAL9005 Replace "B" by "N" in the reference

Without diffuser

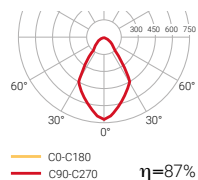

- RAL9016
- RAL7001 Replace "B" by "G" in the reference
- RAL9005 Replace "B" by "N" in the reference

Without diffuser

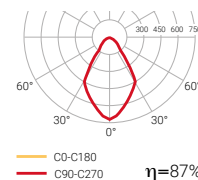

**DALI** Compatible with **NormaliNK**







# Dorfin



DORFIN is a rounded or square swivelling downlight. It is entirely made from die-cast aluminium and the reflector is made of high reflection technical polycarbonate.

DORFIN range is available in white, grey or black colours. It can be supplied without diffuser, with opal glass or with intensive reflector.

Available in:

## Led food

SPECIAL COLOUR TEMPERATURE FOR FOOD INDUSTRY



60000 h.  
L70B10

CRI  
>80-95

△  
17-55°

Efficiency (%)  
89,8

Photobiological safety

RG1\* **1** Low risk

\*Time under 3 h.

Go to page 443 to learn more

Ceiling recessed mounted



RAL9016



RAL7001



RAL9005



With separate electrical equipment, it enables a 85° tilt and 355° rotation.



**CRI 360** | For other CRI values, please contact us.



Please request technical specifications of all the luminaires or visit our website.

	Dorfin	Dorfin Q
Installation	Ceiling recessed mounted	Ceiling recessed mounted
Diffuser	S, M, O	S, M, O
Light source	LED	LED
Photobiological safety	1	1
UGR	19-22	19-22
CRI	>80-95	>80-95
MacAdam ellipse	3	3
Beam angle range	17-55	17-55
Power range (W)	11,8-25,5	11,8-25,5
Colour temperature (°K)	2700   3000   4000   5000	3000   4000   5000
Light range	1760-3780	1760-3780
Power factor	0,95	0,95
Efficiency (%)	89,8	89,8
Expectancy	60000 h L70B10	60000 h L70B10
DALI Option	✓	✓
Continuous operation 24h	✓	✓
IP	20	20
Class	II	II
Ideal cut out (mm)	175	175x175
Energy efficiency	B   C   D   E   G	B   C   D   E   F   G

S: Intesive optics   M: Medium optics   O: Extensive optics

# Dorfin

Ceiling recessed mounted

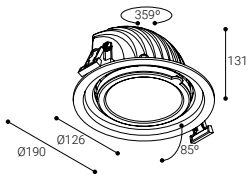

Minimum ceiling installation height **180**

Ideal cut out **Ø175**  
Circular cut

60000 h.  
L70B10

CRI **>80-95**

17-55°

Efficiency (%) **89,8**

Photobiological safety

RG1\* **1** Low risk

\*Time under 3 h.

Go to page 443 to learn more



## INTENSIVE OPTICS / TRANSPARENT DIFFUSER



17°

	K	REF.	W	LUMEN			REF. DALI
IP 20	3000	D23SB	11,8 W	1930 lm		1,2	D23DSB
		D33SB	17,4 W	2650 lm		1,2	D33DSB
		D43SB	25,1 W	3580 lm		1,2	D43DSB
UGR 19	4000	D24SB	11,8 W	2050 lm		1,2	D24DSB
		D34SB	17,4 W	2850 lm		1,2	D34DSB
		D44SB	25,1 W	3780 lm		1,2	D44DSB

## MEDIUM OPTICS / TRANSPARENT DIFFUSER



39°

	K	REF.	W	LUMEN			REF. DALI
IP 20	3000	D23MB	11,8 W	1930 lm		1,2	D23DMB
		D33MB	17,4 W	2650 lm		1,2	D33DMB
		D43MB	25,1 W	3580 lm		1,2	D43DMB
UGR 19	4000	D24MB	11,8 W	2050 lm		1,2	D24DMB
		D34MB	17,4 W	2850 lm		1,2	D34DMB
		D44MB	25,1 W	3780 lm		1,2	D44DMB

- RAL9016
- RAL7001 Replace "B" by "G" in the reference
- RAL9005 Replace "B" by "N" in the reference

- RAL9016
- RAL7001 Replace "B" by "G" in the reference
- RAL9005 Replace "B" by "N" in the reference

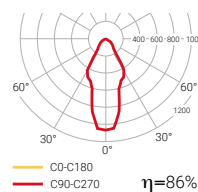
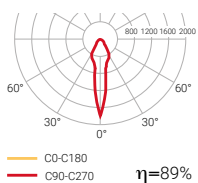

# Dorfin

Ceiling recessed mounted

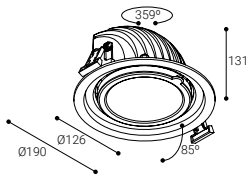

Minimum ceiling installation height  
**180**

Ideal cut out  
**Ø175**  
Circular cut

60000 h.  
L70B10

CRI  
**>80-95**

17-55°

Efficiency (%)  
**89,8**

Photobiological safety

RG1\* **1** Low risk

\*Time under 3 h.

Go to page 443 to learn more



## EXTENSIVE OPTICS / OPAL DIFFUSER

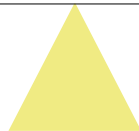

55°

	K	REF.	W	LUMEN			REF. DALI
IP 20	3000	D230B	11,8 W	1930 lm	○	1,2	D23DOB
		D330B	17,4 W	2650 lm	○	1,2	D33DOB
UGR 22	4000	D430B	25,1 W	3580 lm	○	1,2	D43DOB
		D240B	11,8 W	2050 lm	○	1,2	D24DOB
		D340B	17,4 W	2850 lm	○	1,2	D34DOB
		D440B	25,1 W	3780 lm	○	1,2	D44DOB

- RAL9016
- RAL7001 Replace "B" by "G" in the reference
- RAL9005 Replace "B" by "N" in the reference

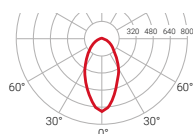

— C0-C180  
— C90-C270  $\eta=86\%$



## ACCESSORY

### Joining accessory

D014

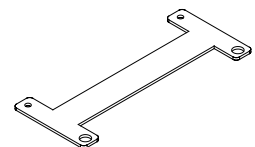

# Dorfin

Ceiling recessed mounted

LED CE RoHS

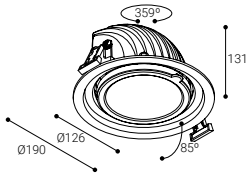

Minimum ceiling installation height **180**

Ideal cut out **Ø175**  
Circular cut

60000 h.  
L70B10

CRI **>80-95**

17-55°

Efficiency (%) **89,8**

Photobiological safety

RG1\* **1** Low risk

\*Time under 3 h.

Go to page 443 to learn more



## Led food

### SPECIAL COLOUR TEMPERATURE FOR FOOD INDUSTRY

Led Bread



**DB**  
3000K  
1785 lm  
CRI 85

Led Meat



**DM**  
4000K  
1760 lm  
CRI 82

Led Fish



**DF**  
5000K  
3250 lm  
CRI 90

### INTENSIVE OPTICS / TRANSPARENT DIFFUSER

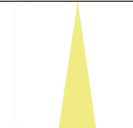

17°

	K	REF.		W	LUMEN		
IP 20	2700	<b>DBSB</b>		24,5 W	2365 lm		1,2
UGR 19	4000	<b>DMSB</b>		25,5 W	1760 lm		1,2
	5000	<b>DFSB</b>		25,5 W	3250 lm		1,2

○ RAL9016

● RAL7001 Replace "B" by "G" in the reference

● RAL9005 Replace "B" by "N" in the reference

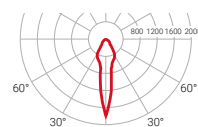

— C0-C180  
— C90-C270  $\eta=89\%$

# Dorfin

Ceiling recessed mounted

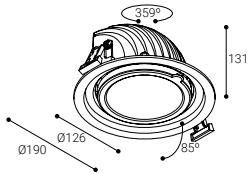

Minimum ceiling installation height **180**

Ideal cut out **Ø175**  
Circular cut

**60000 h.**  
L70B10

CRI **>80-95**

**17-55°**

Efficiency (%) **89,8**

Photobiological safety

**RG1\*** **1** Low risk

\*Time under 3 h.

Go to page 443 to learn more



## MEDIUM OPTICS / TRANSPARENT DIFFUSER

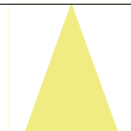

39°

	K	REF.		W	LUMEN		
IP 20	3000	<b>DBMB</b>	🔌	24,5 W	2365 lm	○	1,2
UGR 19	4000	<b>DMMB</b>	🔌	25,5 W	1760 lm	○	1,2
	5000	<b>DFMB</b>	🔌	25,5 W	3250 lm	○	1,2

- RAL9016
- RAL7001 Replace "B" by "G" in the reference
- RAL9005 Replace "B" by "N" in the reference

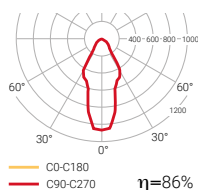

## EXTENSIVE OPTICS / OPAL DIFFUSER



55°

	K	REF.		W	LUMEN		
IP 20	3000	<b>DBOB</b>	🔌	24,5 W	2365 lm	○	1,2
UGR 22	4000	<b>DMOB</b>	🔌	25,5 W	1760 lm	○	1,2
	5000	<b>DFOB</b>	🔌	25,5 W	3250 lm	○	1,2

- RAL9016
- RAL7001 Replace "B" by "G" in the reference
- RAL9005 Replace "B" by "N" in the reference

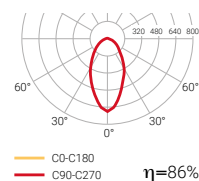

# Dorfin Q

Ceiling recessed mounted

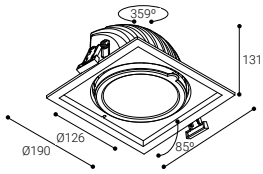

Minimum ceiling installation height  
**150**

175x175  
Ideal cut out  
**175x175**  
Square cut

60000 h.  
L70B10

CRI  
**>80-95**

17-55°

Efficiency (%)  
**89,8**

Photobiological safety

RG1\* **1** Low risk

\*Time under 3 h.

Go to page 443 to learn more



## INTENSIVE OPTICS / TRANSPARENT DIFFUSER



17°

	K	REF.	W	LUMEN			REF. DALI
IP 20	3000	DQ23SB	11,8 W	1930 lm		1,4	DQ23DSB
		DQ33SB	17,4 W	2650 lm		1,4	DQ33DSB
UGR 19	4000	DQ43SB	25,1 W	3580 lm		1,4	DQ43DSB
		DQ24SB	11,8 W	2050 lm		1,4	DQ24DSB
		DQ34SB	17,4 W	2850 lm		1,4	DQ34DSB
		DQ44SB	25,1 W	3780 lm		1,4	DQ44DSB

- RAL9016
- RAL7001 Replace "B" by "G" in the reference
- RAL9005 Replace "B" by "N" in the reference

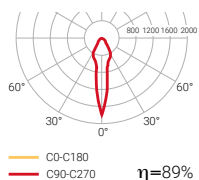

## MEDIUM OPTICS / TRANSPARENT DIFFUSER



39°

	K	REF.	W	LUMEN			REF. DALI
IP 20	3000	DQ23MB	11,8 W	1930 lm		1,2	DQ23DMB
		DQ33MB	17,4 W	2650 lm		1,4	DQ33DMB
UGR 19	4000	DQ43MB	25,1 W	3580 lm		1,4	DQ43DMB
		DQ24MB	11,8 W	2050 lm		1,2	DQ24DMB
		DQ34MB	17,4 W	2850 lm		1,4	DQ34DMB
		DQ44MB	25,1 W	3780 lm		1,4	DQ44DMB

- RAL9016
- RAL7001 Replace "B" by "G" in the reference
- RAL9005 Replace "B" by "N" in the reference

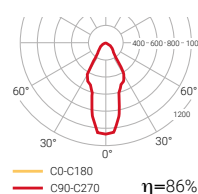



# Dorfin Q

Ceiling recessed mounted

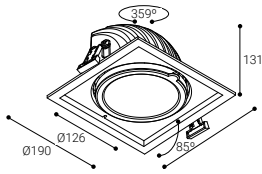

Minimum ceiling installation height  
**150**

175x175  
Ideal cut out  
**175x175**  
Square cut

60000 h.  
L70B10

CRI  
**>80-95**

17-55°

Efficiency (%)  
**89,8**

Photobiological safety

RG1\* **1** Low risk

\*Time under 3 h.

Go to page 443 to learn more



## EXTENSIVE OPTICS / OPAL DIFFUSER

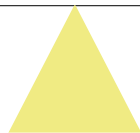

55°

	K	REF.	W	LUMEN			REF. DALI
IP 20	3000	DQ23OB	11,8 W	1930 lm		1,4	DQ23DOB
		DQ33OB	17,4 W	2650 lm		1,4	DQ33DOB
UGR 22	4000	DQ43OB	25,1 W	3580 lm		1,4	DQ43DOB
		DQ24OB	11,8 W	2050 lm		1,4	DQ24DOB
		DQ34OB	17,4 W	2850 lm		1,4	DQ34DOB
		DQ44OB	25,1 W	3780 lm		1,4	DQ44DOB

- RAL9016
- RAL7001 Replace "B" by "G" in the reference
- RAL9005 Replace "B" by "N" in the reference

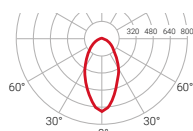

— C0-C180  
— C90-C270  $\eta=86\%$



## ACCESSORY

### Joining accessory

D014

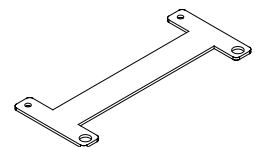

# Dorfin Q

Ceiling recessed mounted

LED CE RoHS

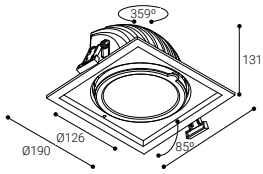

Minimum ceiling installation height  
**150**

Ideal cut out  
**175x175**  
Square cut

60000 h.  
L70B10

CRI  
**>80-95**

17-55°

Efficiency (%)  
**89,8**

Photobiological safety

RG1\* **1** Low risk

\*Time under 3 h.

Go to page 443 to learn more



## Led food

SPECIAL COLOUR TEMPERATURE FOR FOOD INDUSTRY

Led Bread



**DQB**  
3000K  
1785 lm  
CRI 85

Led Meat



**DQM**  
4000K  
1760 lm  
CRI 82

Led Fish



**DQF**  
5000K  
3250 lm  
CRI 90

INTENSIVE OPTICS / TRANSPARENT DIFFUSER

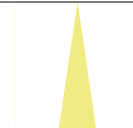

17°

	K	REF.	W	LUMEN		
IP 20	3000	<b>DQBSB</b>	24,5 W	2365 lm	○	1,4
UGR 19	4000	<b>DQMSB</b>	25,5 W	1760 lm	○	1,4
	5000	<b>DQFSB</b>	25,5 W	3250 lm	○	1,4

○ RAL9016

● RAL7001 Replace "B" by "G" in the reference

● RAL9005 Replace "B" by "N" in the reference

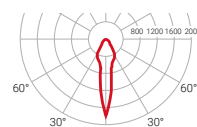

— C0-C180  
— C90-C270  $\eta=89\%$

# Dorfin Q

Ceiling recessed mounted

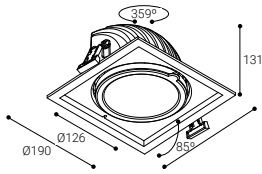

Minimum ceiling installation height **150**

Ideal cut out **175x175** Square cut

**60000 h.**  
L70B10

CRI **>80-95**

**17-55°**

Efficiency (%) **89,8**

Photobiological safety

**RG1\*** **1** Low risk

\*Time under 3 h.

Go to page 443 to learn more



## MEDIUM OPTICS / TRANSPARENT DIFFUSER

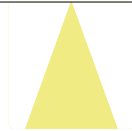

39°

## EXTENSIVE OPTICS / OPAL DIFFUSER



55°

	K	REF.		W	LUMEN		
IP 20	3000	<b>DQBMB</b>	🔌	24,5 W	2365 lm	○	1,4
UGR 19	4000	<b>DQMMB</b>	🔌	21,0 W	1760 lm	○	1,4
	5000	<b>DQFMB</b>	🔌	25,5 W	3250 lm	○	1,4

	K	REF.		W	LUMEN		
IP 20	3000	<b>DQBOB</b>	🔌	24,5 W	2365 lm	○	1,4
UGR 22	4000	<b>DQMOB</b>	🔌	25,5 W	1760 lm	○	1,4
	5000	<b>DQFOB</b>	🔌	25,5 W	3250 lm	○	1,4

- RAL9016
- RAL7001 Replace "B" by "G" in the reference
- RAL9005 Replace "B" by "N" in the reference

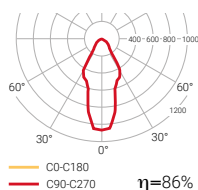

- RAL9016
- RAL7001 Replace "B" by "G" in the reference
- RAL9005 Replace "B" by "N" in the reference

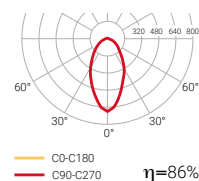

# Surface downlights





Elit S  
**150**



Hat S  
**155**



Cyre  
**158**



Pendulars  
**164**



Pagoda  
**170**

# Elit S



Version of the ELIT range for ceiling surface mounting.

Is made of anodised aluminium and can be provided in white, grey or black.



 **60000 h.**  
L70B10

CRI  
**>80**

 **99°**

Efficiency (%)  
**95,4**

Photobiological safety

**RG1\***  Low risk

\*Time under 3 h.

**Go to page 443 to learn more**

Surface ceiling mounted

Available in two sizes  
(standard and micro)

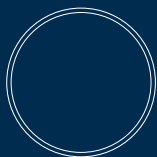

Elit S  
Ø198 mm



Elit Micro S  
Ø69 mm



For other CRI values,  
please contact us.



RAL9016



RAL7001



RAL9005



## Elit S

## Elit Micro S

Installation	Surface ceiling mounted	Surface ceiling mounted
Diffuser	⊙	⊙
Light source	LED	LED
Photobiological safety	1	1
UGR	19	19
CRI	>80	>80
MacAdam ellipse	3	4
Beam angle range	99	94
Power range (W)	11,8-17,4	6,4
Colour temperature (°K)	3000   4000	3000   4000
Light range	1930-2850	760-885
Power factor	0,95	0,90
Efficiency (%)	95,4	92,9
Expectancy	60000 h L70B10	60000 h L70B10
DALI Option	✓	✓
Continuous operation 24h	✓	✓
IP	20	20
Class	I	I
Energy efficiency	B   C	C   D

⊙ Without diffuser

# Elit S

Surface ceiling mounted

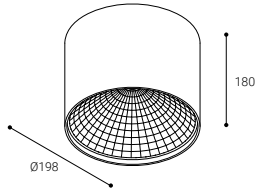
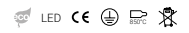

60000 h. L70B10 | CRI >80 | 99° | Efficiency (%) 95,4

Photobiological safety

RG1\* 1 Low risk

\*Time under 3h.

Go to page 443 to learn more



## WITHOUT DIFFUSER

	K	REF.	W	LUMEN			REF. DALI
IP 20	3000	ELA23B	11,8 W	1930 lm	○	2,9	ELA23DB
		ELA33B	17,4 W	2650 lm	○	2,9	ELA33DB
UGR 19	4000	ELA24B	11,8 W	2050 lm	○	2,9	ELA24DB
		ELA34B	17,4 W	2850 lm	○	2,9	ELA34DB

- RAL9016
- RAL7001 Replace "B" by "G" in the reference
- RAL9005 Replace "B" by "N" in the reference

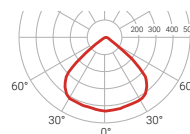

DALI Compatible with Normalink

CO-C180 C90-C270  $\eta=95\%$



# Elit Micro S

Surface ceiling mounted

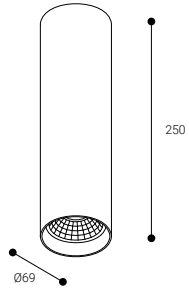

<b>60000 h.</b> L70B10	CRI <b>&gt;80</b>	<b>94°</b>	Efficiency (%) <b>92,9</b>
---------------------------	----------------------	------------	-------------------------------

Photobiological safety

**RG1\*** **1** Low risk

\*Time under 3 h.

Go to page 443 to learn more



## ○ WITHOUT DIFFUSER

	K	REF.	W	LUMEN			REF. DALI
IP <b>20</b>	3000	<b>EPA03B</b>	6,4 W	760 lm	○	0,8	<b>EPA03DB</b>
UGR <b>19</b>	4000	<b>EPA04B</b>	6,4 W	885 lm	○	0,8	<b>EPA04DB</b>

- RAL9016
- RAL7001 Replace "B" by "G" in the reference
- RAL9005 Replace "B" by "N" in the reference

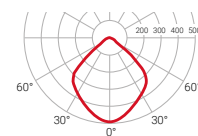

Compatible with **NormaLINK**

— C0-C180  $\eta=93\%$   
— C90-C270



# Hat S



72000 h.  
L70B10

CRI  
**>80**

Beam angle  
**84°**

Efficiency (%)  
**75,1**

Photobiological safety

**RG0** **0** Risk free

\*Time under 3 h.

[Go to page 443 to learn more](#)

Surface ceiling mounted

Wall surface mounted



## Hat S

Surface ceiling mounted  
Wall surface mounted

Installation	
Diffuser	
Light source	LED
Photobiological safety	0
UGR	22
CRI	>80
MacAdam ellipse	3
Beam angle range	84
Power range (W)	17
Colour temperature (°K)	3000   4000   5000   6000
Light range	1800-1920
Power factor	0,98
Efficiency (%)	75,1
Expectancy	72000 h L70B10
DALI Option	—
Continuous operation 24h	✓
IP	30
Class	I
Energy efficiency	E

 Microprismatic diffuser

CRI 360

For other CRI values,  
please contact us.



RAL9016



RAL7001



RAL9005

# Hat S

Surface ceiling mounted

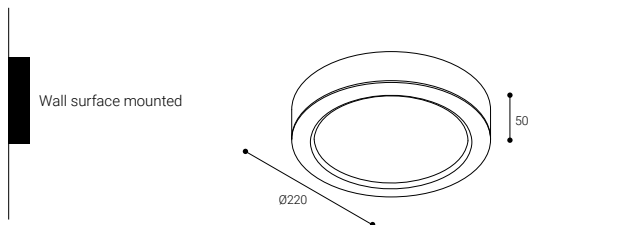
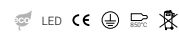

72000 h.  
L70B10

CRI  
>80

84°

Efficiency (%)  
75,1

Photobiological safety

RG0 **0** Risk free

\*Time under 3 h.

Go to page 443 to learn more



## © MICROPRISMATIC DIFFUSER

	K	REF.	W	LUMEN			REF. DALI
IP 30	3000	<b>EHS23B</b>	17 W	1800 lm		1,0	—
UGR 22	4000	<b>EHS24B</b>	17 W	1900 lm		1,0	—
	5000	<b>EHS25B</b>	17 W	1920 lm		1,0	—
	6000	<b>EHS26B</b>	17 W	1920 lm		1,0	—

- RAL9016
- RAL7001 Replace "B" by "G" in the reference
- RAL9005 Replace "B" by "N" in the reference

220V LED,  
DOES NOT NEED A DRIVER

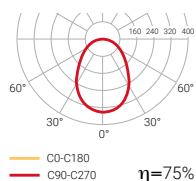

# Cyre



CYRE is a range of luminaires for suspended mounting in the ceiling. They are based on a cylindrical extruded aluminium profile and have a reflector made of high reflection technical polycarbonate.



**60000 h.**  
L70B10

CRI  
**>80**

△  
**99°**

Efficiency (%)  
**95,4**

Photobiological safety

**RG1\*** **1** Low risk

\*Time under 3 h.

**Go to page 443 to learn more**

Suspended ceiling mounted



## Luminaires with decorative value

Create lighting levels at different heights and fill spaces with a range of suspended downlights that have been designed to light surfaces with different formats and conform welcoming atmospheres.

Available in two sizes (standard and micro)

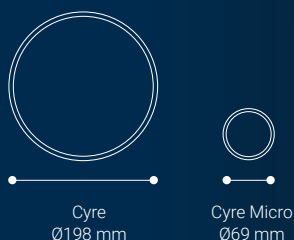

RAL9016



RAL7001



RAL9005



### Cyre

### Cyre Micro

Installation	Suspended ceiling mounted	Suspended ceiling mounted
Diffuser	☉	☉
Light source	LED	LED
Photobiological safety	1	1
UGR	19	19
CRI	>80	>80
MacAdam ellipse	3	4
Beam angle range	99	94
Power range (W)	11,8-17,4	6,4
Colour temperature (°K)	3000   4000	3000   4000
Light range	1930-2850	760-885
Power factor	0,95	0,92
Efficiency (%)	95,4	92,9
Expectancy	60000 h L70B10	60000 h L70B10
DALI Option	✓	✓
Continuous operation 24h	✓	✓
IP	20	20
Class	I	I
Energy efficiency	B   C	C   D

☉ Without diffuser



For other CRI values, please contact us.







### Creativity and colour

Customise your space with a pure, elegant colour chart to create creative, free-form scenes in white, black and grey. Create original, attractive atmospheres with an exclusive solution capable of merging into the space, completing the design of working areas, retail premises and offices.

# Cyre

Suspended ceiling mounted

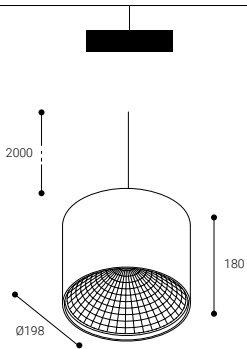
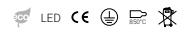

60000 h. L70B10 | CRI >80 | 99° | Efficiency (%) 95,4

Photobiological safety

RG1\* **1** Low risk

\*Time under 3 h.

Go to page 443 to learn more



## WITHOUT DIFFUSER

	K	REF.	W	LUMEN			REF. DALI
IP 20	3000	CYL23B	11,8 W	1930 lm		2,9	CYL23DB
		CYL33B	17,4 W	2650 lm		2,9	CYL33DB
UGR 19	4000	CYL24B	11,8 W	2050 lm		2,9	CYL24DB
		CYL34B	17,4 W	2850 lm		2,9	CYL34DB

- RAL9016
- RAL7001 Replace "B" by "G" in the reference
- RAL9005 Replace "B" by "N" in the reference

Without diffuser

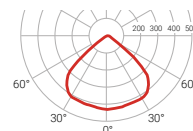

CO-C180  
C90-C270  $\eta=95\%$

Compatible with

# Cyre Micro

Suspended ceiling mounted

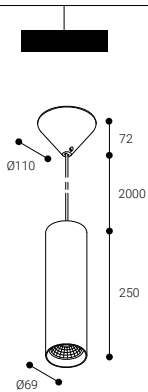

60000 h.  
L70B10

CRI  
>80

94°

Efficiency (%)  
92,9

Photobiological safety

RG1\* **1** Low risk

\*Time under 3 h.

Go to page 443 to learn more



## WITHOUT DIFFUSER

	K	REF.	W	LUMEN			REF. DALI
IP 20	3000	<b>CYP03B</b>	6,4 W	760 lm		0,8	<b>CYP03DB</b>
UGR 19	4000	<b>CYP04B</b>	6,4 W	885 lm		0,8	<b>CYP04DB</b>

- RAL9016
- RAL7001 Replace "B" by "G" in the reference
- RAL9005 Replace "B" by "N" in the reference

Without diffuser

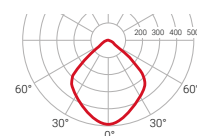

CO-C180  
C90-C270  $\eta=93\%$

# Pendulars



PENDULAR is a range of suspended luminaires especially designed to be installed in places with high ceilings and wide spaces. Extruded and anodised aluminium body.

 **60000 h.**  
L70B10

 CRI  
**>80-95**

 **27-41°**

Efficiency (%)  
**92,5**

Photobiological safety

**RG1\***  Low risk

\*Time under 3 h.

**Go to page 443 to learn more**

Available in:

Led food

SPECIAL COLOUR  
TEMPERATURE  
FOR FOOD INDUSTRY



Suspended ceiling mounted



Two different types of reflector, in anodised aluminium or acrylic (Lexalon).



For other CRI values, please contact us.

## Pendulars

Installation	Suspended ceiling mounted
Diffuser	☉
Light source	LED
Photobiological safety	1
UGR	19
CRI	>80-95
MacAdam ellipse	3
Beam angle range	27-41
Power range (W)	11,8-39,4
Colour temperature (°K)	2700   3000   4000   5000
Light range	1760-6100
Power factor	0,95
Efficiency (%)	92,5
Expectancy	60000 h L70B10
DALI Option	✓
Continuous operation 24h	✓
IP	20
Class	I
Energy efficiency	B   C   D   E   G

☉ Without diffuser

# Pendulars

Suspended ceiling mounted

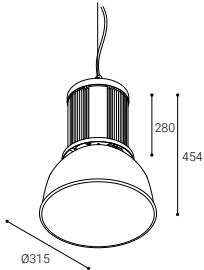

60000 h.  
L70B10

CRI  
>80-95

27-41°

Efficiency (%)  
92,5

Photobiological safety

RG1\* **1** Low risk

\*Time under 3h.

Go to page 443 to learn more

## ACRYLIC REFLECTOR

	K	REF.	W	LUMEN			REF. DALI
IP 20	3000	VP12L23	11,8 W	1930 lm		3,4	VP12L23D
		VP12L33	17,4 W	2650 lm		3,4	VP12L33D
		VP12L43	25,1 W	3580 lm		3,4	VP12L43D
UGR 19	4000	VP12L53	39,4 W	4750 lm		3,4	VP12L53D
		VP12L63	35,2 W	5800 lm		3,4	VP12L63D
		VP12L24	11,8 W	2050 lm		3,4	VP12L24D
		VP12L34	17,4 W	2850 lm		3,4	VP12L34D
		VP12L44	25,1 W	3780 lm		3,4	VP12L44D
		VP12L54	39,4 W	4980 lm		3,4	VP12L54D
		VP12L64	35,2 W	6100 lm		3,4	VP12L64D

Aluminium

Without diffuser

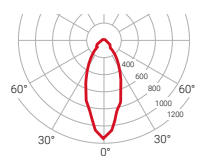

Compatible with

## Led food

### SPECIAL COLOUR TEMPERATURE FOR FOOD INDUSTRY

Led Bread	Led Meat	Led Fish
VP12LB 3000K 2540 lm CRI 85	VP12LM 4000K 1760 lm CRI 82	VP12LF 5000K 3250 lm CRI 90

K	REF.	W	LUMEN		
2700	VP12LB	24,5 W	2365 lm		3,4
4000	VP12LM	25,5 W	1760 lm		3,4
5000	VP12LF	25,5 W	3250 lm		3,4

# Pendulars

Suspended ceiling mounted

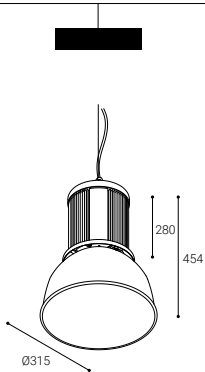

LED CE ENEC

60000 h. L70B10 | CRI >80-90 |  $\Delta$  28-41° | Efficiency (%) 87,6

Photobiological safety

RG1\* **1** Low risk

\*Time under 3 h.

Go to page 443 to learn more

## ALUMINIUM REFLECTOR

	K	REF.	W	LUMEN			REF. DALI
IP 20	3000	VPA12L23	11,8 W	1930 lm		3,4	VPA12L23D
		VPA12L33	17,4 W	2650 lm		3,4	VPA12L33D
UGR 19	3000	VPA12L43	25,1 W	3580 lm		3,4	VPA12L43D
		VPA12L53	39,4 W	4750 lm		3,4	VPA12L53D
		VPA12L63	35,2 W	5800 lm		3,4	VPA12L63D
		VPA12L24	11,8 W	2050 lm		3,4	VPA12L24D
3000	4000	VPA12L34	17,4 W	2850 lm		3,4	VPA12L34D
		VPA12L44	25,1 W	3780 lm		3,4	VPA12L44D
		VPA12L54	39,4 W	4980 lm		3,4	VPA12L54D
		VPA12L64	35,2 W	6100 lm		3,4	VPA12L64D

Aluminium

Without diffuser

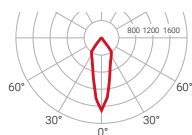

— CO-C180  
— C90-C270  $\eta=87\%$

Compatible with

## Led food

### SPECIAL COLOUR TEMPERATURE FOR FOOD INDUSTRY

Led Bread	Led Meat	Led Fish
VPA12LB 3000K 2540 lm CRI 85	VPA12LM 4000K 1760 lm CRI 82	VPA12LF 5000K 3250 lm CRI 90

K	REF.	W	LUMEN		
3000	VPA12LB	24,5 W	2365 lm		3,4
4000	VPA12LM	25,5 W	1760 lm		3,4
5000	VPA12LF	25,5 W	3250 lm		3,4

# Pendulars

ACCESSORIES

Suspension accessory

	L (m)	COLOUR
<b>1027VPG</b>	4	●
<b>1028VPG</b>	2	●
<b>1029L2VP</b>	2	●
<b>1029L4VP</b>	4	●

The suspension accessory does not include the power cable.

**1027VPG**  
**1028VPG**



**1029L2VP**  
**1029L4VP**

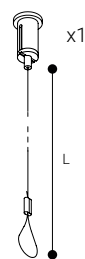



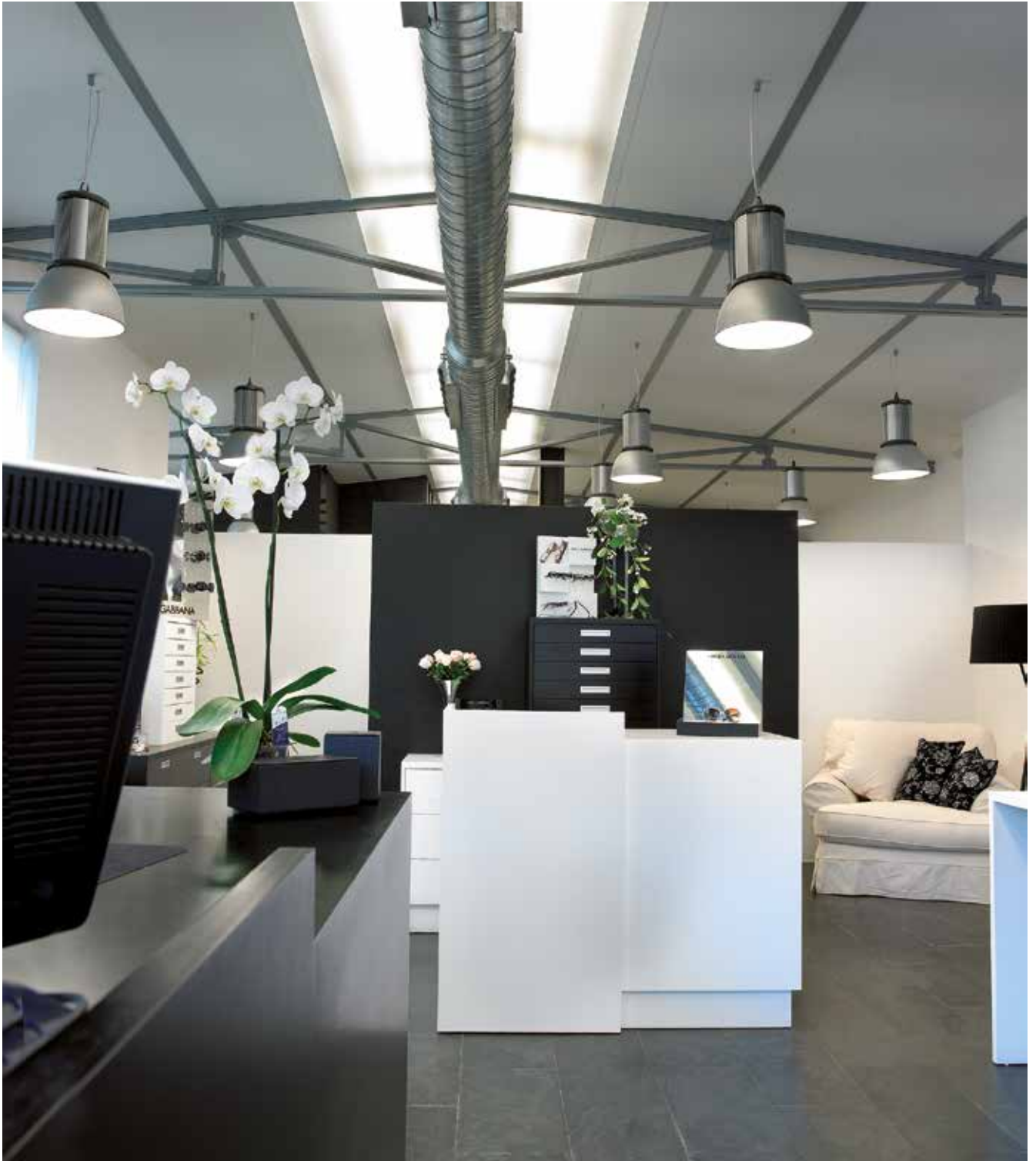

# Pagoda



Luminaire to be suspended from the ceiling. Consists of an external aluminium housing with a second reflector and the electronic equipment inside. Tempered glass is used to close the set. Suspended by a metal wire.

Available in:

Led food

SPECIAL COLOUR  
TEMPERATURE  
FOR FOOD INDUSTRY



60000 h.  
L70B10

CRI  
>80-95

94°

Efficiency (%)  
89,2

Photobiological safety

RG1\* **1** Low risk

\*Time under 3h.

Go to page 443 to learn more

Suspended ceiling mounted



## Pagoda

Installation	Suspended ceiling mounted
Diffuser	☉
Light source	LED
Photobiological safety	1
UGR	22
CRI	>80-95
MacAdam ellipse	3
Beam angle range	94
Power range (W)	17,4-35,2
Colour temperature (°K)	2700   3000   4000   5000
Light range	1760-6100
Power factor	0,95
Efficiency (%)	89,2
Expectancy	60000 h L70B10
DALI Option	✓
Continuous operation 24h	✓
IP	20
Class	I
Energy efficiency	B   C   D   E   G

☉ Concentric diffuser



For other CRI values,  
please contact us.

# Pagoda

Suspended ceiling mounted

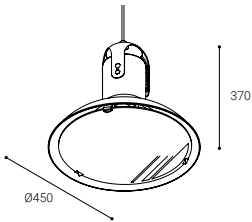

60000 h. L70B10 | CRI >80-95 | 94° | Efficiency (%) 89,2

Photobiological safety

RG1\* 1 Low risk

\*Time under 3h.

Go to page 443 to learn more



## CONCENTRIC DIFFUSER

	K	REF.	W	LUMEN			REF. DALI
IP 20	3000	VG33G	17,4 W	2650 lm	60°	3,9	VG33DG
		VG43G	25,1 W	3580 lm	60°	3,9	VG43DG
		VG63G	35,2 W	5800 lm	60°	3,9	VG63DG
UGR 22	4000	VG34G	17,4 W	2850 lm	60°	3,9	VG34DG
		VG44G	25,1 W	3780 lm	60°	3,9	VG44DG
		VG64G	35,2 W	6100 lm	60°	3,9	VG64DG

● RAL7001

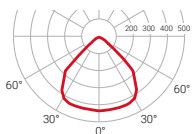

— C0-C180  
— C90-C270  $\eta=89\%$

**DALI** Compatible with **NormaLINK**

## Led food

### SPECIAL COLOUR TEMPERATURE FOR FOOD INDUSTRY

Led Bread	Led Meat	Led Fish
VG BG 3000K 2540 lm CRI 85	VG MG 4000K 1760 lm CRI 82	VG FG 5000K 3250 lm CRI 90

K	REF.		W	LUMEN		
2700	VG BG		24,5 W	2365 lm	60°	3,9
4000	VG MG		25,5 W	1760 lm	60°	3,9
5000	VG FG		25,5 W	3250 lm	60°	3,9

# Pagoda

ACCESSORIES

Suspension accessory

	L (m)	COLOUR
<b>1027VPG</b>	4	●
<b>1028VPG</b>	2	●
<b>1029L2VP</b>	2	●
<b>1029L4VP</b>	4	●

1027VPG  
1028VPG

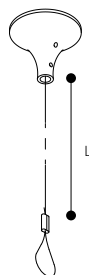

1029L2VP  
1029L4VP

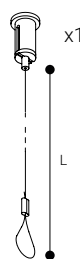

The suspension accessory does not include the power cable.



# LED Panels





Nassel Avant  
**176**

Available in S&LUZ\*



Nassel  
**182**



Nassel S  
**190**



Luzerna Avant  
**194**

Available in S&LUZ\*



SeaLED  
**206**

Available in S&LUZ\*

# Nassel Avant



NASSEL AVANT is a LED panel with a metallic frame and a multi-reflector plastic system that provides uniform and comfortable lighting in the workplace environment.

Available in:

**SALUZ**<sup>®</sup>

Two sizes



594x594 mm



1194x294 mm

Ceiling recessed mounted





## Nassel Avant

Installation	Ceiling recessed mounted
Diffuser	☉
Light source	LED
Photobiological safety	0
UGR	16
CRI	>80
MacAdam ellipse	3
Beam angle range	77
Power range (W)	25,9-27
Colour temperature (°K)	2700   3000   4000   5600   6500
Light range	3345-5000
Power factor	0,95
Efficiency (%)	73
Expectancy	72000 h L70B10
DALI Option	✓
Continuous operation 24h	✓
IP	44
Class	II
Ideal cut out (mm)	600x600   1200x300
Energy efficiency	A   B   D

☉ Without diffuser



Version  
**saluz**<sup>®</sup>  
 page 180

**CRI 360** | For other CRI values,  
 please contact us.

NUMBER OF FITTINGS NEEDED IN A  
 STANDARD INSTALLATION

### NX34

	200 lx	300 lx	500 lx
50 m <sup>2</sup>	3	5	10
100 m <sup>2</sup>	7	11	18
150 m <sup>2</sup>	10	16	26
200 m <sup>2</sup>	14	22	36

Height used for the calculation: 2,8 m

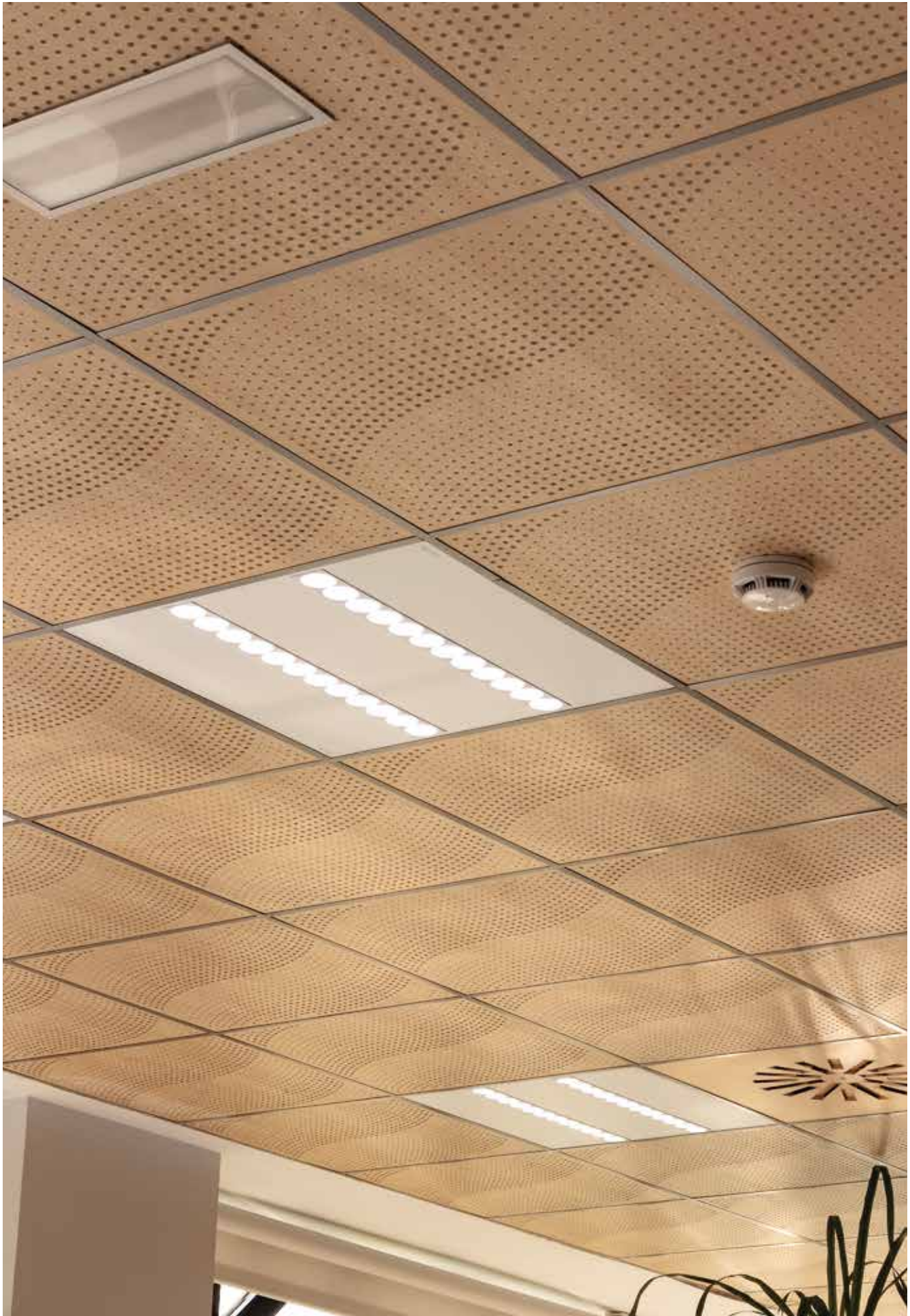

# Nassel Avant

Ceiling recessed mounted

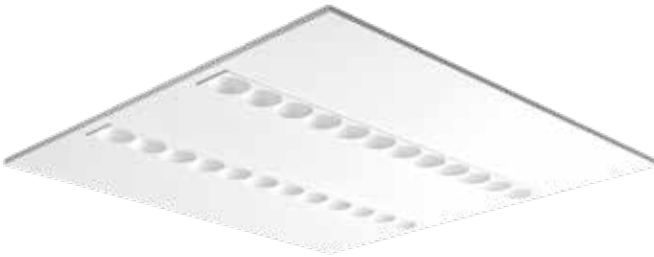

72000 h.  
L70B10

CRI  
>80

77°

Efficiency (%)  
73

Photobiological safety

RG0 **0** Risk free

\*Time under 3 h.

Go to page 443 to learn more

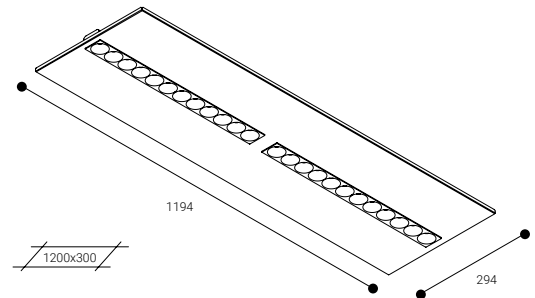
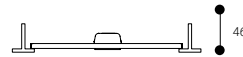
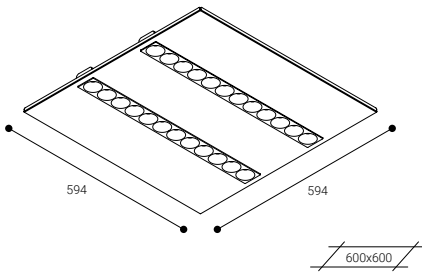

## WITHOUT DIFFUSER

	K	REF.	W	LUMEN				REF DALI
IP 44	3000	<b>NX33B</b>	27 W	4800 lm	○	2,9	4	<b>NX33DB</b>
UGR 16	4000	<b>NX34B</b>	27 W	5000 lm	○	2,9	4	<b>NX34DB</b>

	K	REF.	W	LUMEN				REF DALI
IP 44	3000	<b>NX43B</b>	27 W	4800 lm	○	2,9	5	<b>NX43DB</b>
UGR 16	4000	<b>NX44B</b>	27 W	5000 lm	○	2,9	5	<b>NX44DB</b>

RAL9016

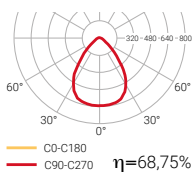

Compatible with **NormaLINK**

RAL9016

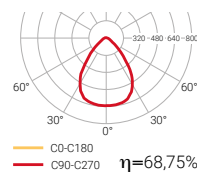

Compatible with **NormaLINK**

# Nassel Avant **saLuz**<sup>®</sup>

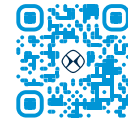

SaLuz<sup>®</sup> Video  
and more information

Ceiling recessed mounted

LED CE RoHS

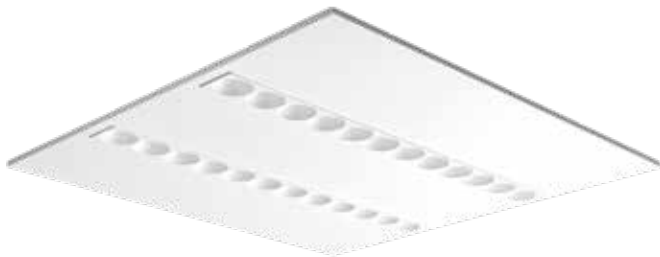

72000 h.  
L70B10

CRI  
>80

77°

Efficiency (%)  
73

Photobiological safety

RG0 **0** Risk free

\*Time under 3h.

Go to page 443 to learn more

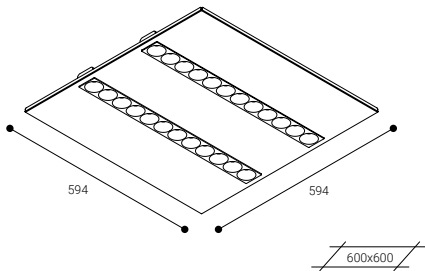

saLuz<sup>®</sup>

WITHOUT DIFFUSER

	K	REF.	W	LUMEN			
IP 44	2700-5600	NX3ZB	25,9 W	3345 lm	○	2,9	1
		NX3ZSB	25,9 W	3345 lm	○	2,9	1
UGR 16	2700-6500	NX3TWB	25,9 W	3345 lm	○	2,9	1

○ RAL9016

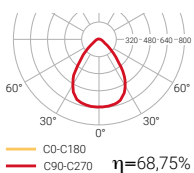

## ● saLuz<sup>®</sup> Self-contained

Once the luminaire has been connected to mains, it automatically modifies the intensity and the tone of the light all over the day.

## ● saLuz<sup>®</sup> Self-contained+

+ LIGHT SENSOR

Same features as the self-contained version but additionally including a sensor which makes it possible to regulate the amount of light.

## ● saLuz<sup>®</sup> Tunable white

COMPATIBLE WITH NORMALINK

This version makes it possible to modify circadian cycles from Normalink in remote, and also to adapt them to the specific needs of the project.

# Nassel Avant

## ACCESSORIES

Suspension kit (all models)

**NXKS**

 EACH KIT INCLUDES 4 UNITS OF NXKS FOR THE INSTALLATION OF ONE UNIT

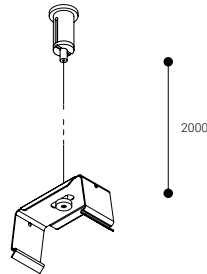

Normagrup  
**360**

## Customize your finish

Personalized luminaires according to different finishings, installations and configurations. [Request information](#).



Main customizable features:

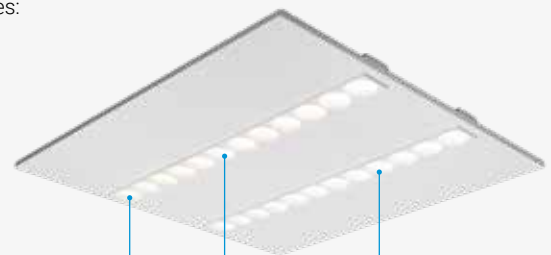

Lm

Lumen output

K

Colour temperature

CRI

Color rendering index

**Customized solutions**

# Nassel



IDEPA prize  
"Best innovative project"

Nassel is an innovative LED luminaire model particularly suitable for modular ceilings. Achieves direct and comfortable light thanks to the combination of two diffusers (a microprismatic diffuser and an opal diffuser) and a highly reflective thermoplastic reflector.

NASSEL S is the version of this fitting for surface ceiling mounting.



**60000 h.**  
L70B10

CRI  
**>80**

$\Delta$   
**73°**

Efficiency (%)  
**80,3**

Photobiological safety

RG0 **0** Risk free

\*Time under 3 h.

**Go to page 443 to learn more**

Ceiling recessed mounted



NUMBER OF FITTINGS NEEDED IN A  
STANDARD INSTALLATION

**NS34B**

	200 lx	300 lx	500 lx
50 m <sup>2</sup>	3	4	6
100 m <sup>2</sup>	4	8	10
150 m <sup>2</sup>	6	10	15
200 m <sup>2</sup>	6	12	20

Height used for the calculation: 2,8 m

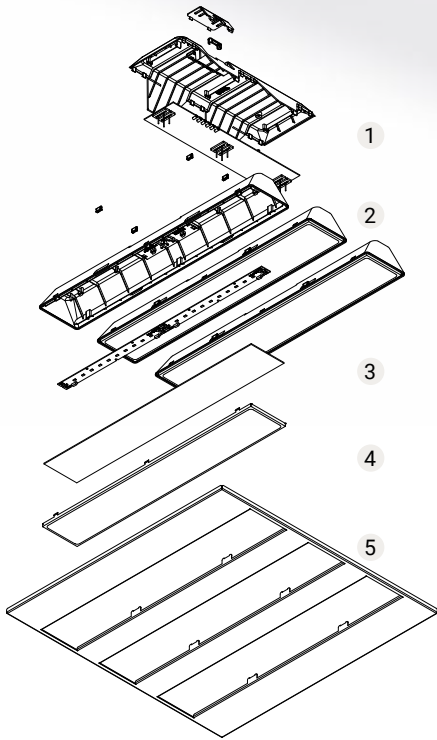

- 1 Terminal board
- 2 Heat sink
- 3 Intermediate diffuser
- 4 Microprismatic diffuser
- 5 Housing

## Nassel

Ceiling recessed mounted

## Nassel S

Surface ceiling mounted  
Suspended ceiling mounted

Installation	Ceiling recessed mounted	Surface ceiling mounted Suspended ceiling mounted
Diffuser	⊙	⊙
Light source	LED	LED
Photobiological safety	0	0
UGR	16	16
CRI	>80	>80
MacAdam ellipse	3	3
Beam angle range	73	73
Power range (W)	24-48	24-48
Colour temperature (°K)	3000   4000	3000   4000
Light range	3400-7400	3400-7400
Power factor	0,95	0,95
Efficiency (%)	80,3	80,3
Expectancy	60000 h L70B10	60000 h L70B10
DALI Option	✓	✓
Continuous operation 24h	✓	✓
IP	20-44	20-30
Class	II	II
Ideal cut out (mm)	600x600   1200x300   1200x600	
Energy efficiency	C	C

⊙ Microprismatic diffuser

**CRI 360** | For other CRI values, please contact us.



Please request technical specifications of all the luminaires or visit our website.

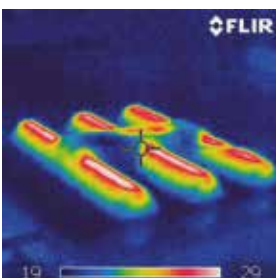





### Nassel

Modular ceiling mounted

594x594 mm 

1194x294 mm 

1194x594 mm 

Ceiling recessed mounted



Plasterboard ceiling mounted

635x635 mm 

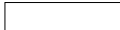
1220x360 mm 

Ceiling recessed mounted



### Nassel S

610x460 mm 

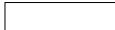
1220x300 mm 

Surface ceiling mounted



610x460 mm 

1220x300 mm 

Suspended ceiling mounted

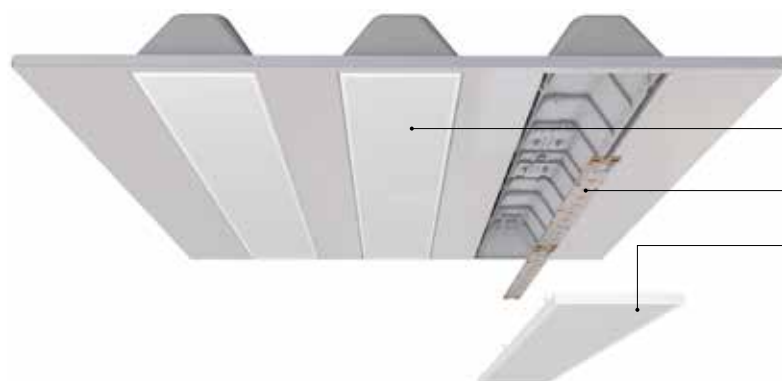

- 1 Light structure and less weight
- 2 Interchangeable LED plate, Zhaga standard
- 3 Microprismatic diffuser for a better performance of the light output (UGR<19)

# Nassel

Ceiling recessed mounted

LED CE RoHS

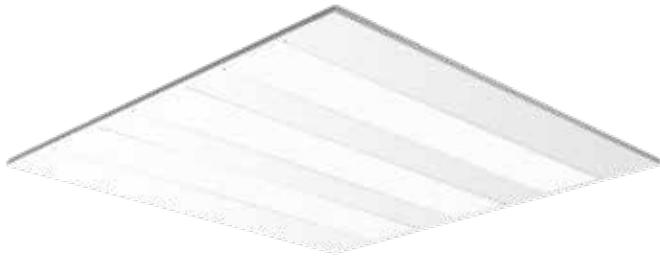

60000 h. L70B10 | CRI >80 | 73° | Efficiency (%) 80,3

Photobiological safety

RG0 Risk free

\*Time under 3h.

Go to page 443 to learn more

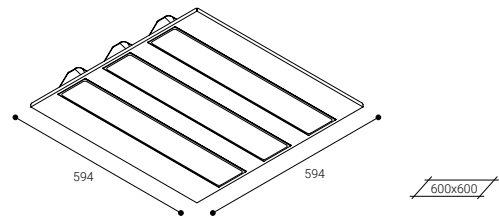
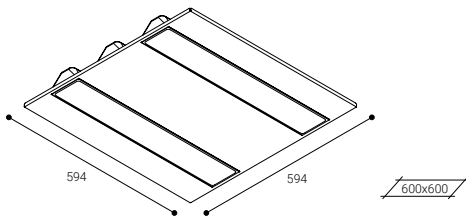
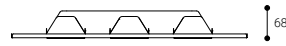
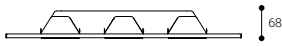

## Modular ceiling mounted

### © MICROPRISMATIC DIFFUSER

	K	REF.	W	LUMEN			REF. DALI
IP 20-44	3000	<b>NS23B</b>	24 W	3400 lm	○	2,9	<b>NS23DB</b>
UGR 16	4000	<b>NS24B</b>	24 W	3700 lm	○	2,9	<b>NS24DB</b>

	K	REF.	W	LUMEN			REF. DALI
IP 20-44	3000	<b>NS33B</b>	36 W	5100 lm	○	2,9	<b>NS33DB</b>
UGR 16	4000	<b>NS34B</b>	36 W	5550 lm	○	2,9	<b>NS34DB</b>

○ RAL9016

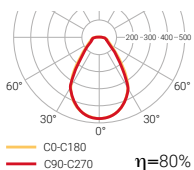

DALI Compatible with NormaLINK

360 Customization options available

# Nassel

Modular ceiling mounted

Ceiling recessed mounted



60000 h.  
L70B10

CRI  
>80

73°

Efficiency (%)  
80,3

Photobiological safety

RG0 **0** Risk free

\*Time under 3 h.

Go to page 443 to learn more

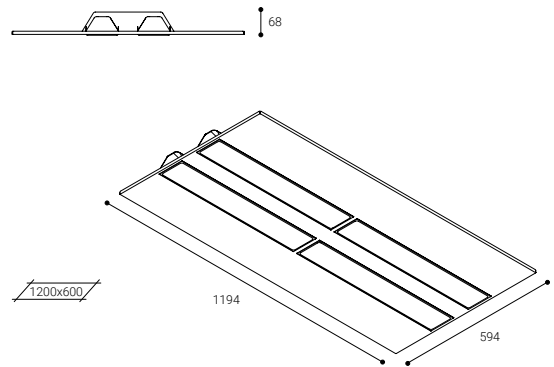
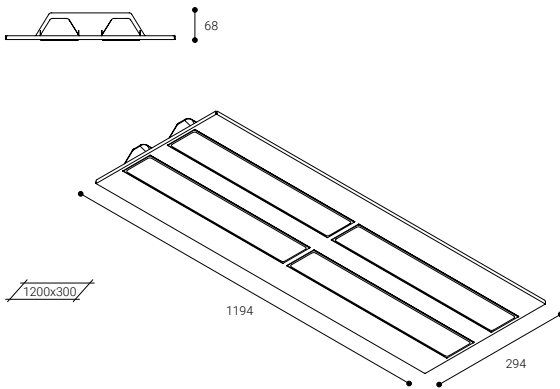

	K	REF.	W	LUMEN			REF. DALI
IP <b>20-44</b>	3000	<b>NS43B</b>	48 W	6800 lm	○	2,9	<b>NS43DB</b>
UGR <b>16</b>	4000	<b>NS44B</b>	48 W	7400 lm	○	2,9	<b>NS44DB</b>

	K	REF.	W	LUMEN			REF. DALI
IP <b>20-44</b>	3000	<b>NS53B</b>	48 W	6800 lm	○	7,0	<b>NS53DB</b>
UGR <b>16</b>	4000	<b>NS54B</b>	48 W	7400 lm	○	7,0	<b>NS54DB</b>

# Nassel Plasterboard ceilings

Ceiling recessed mounted

LED CE RoHS

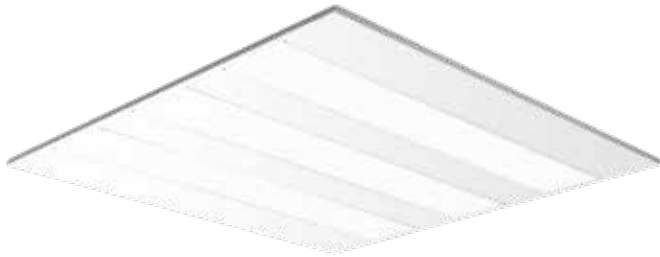

60000 h. L70B10 | CRI >80 | 73° | Efficiency (%) 80,3

Photobiological safety

RG0 Risk free

\*Time under 3h.

Go to page 443 to learn more

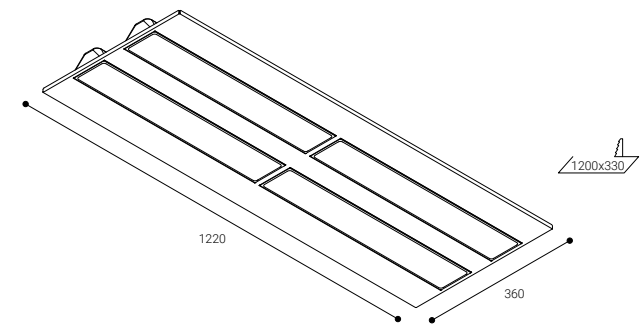
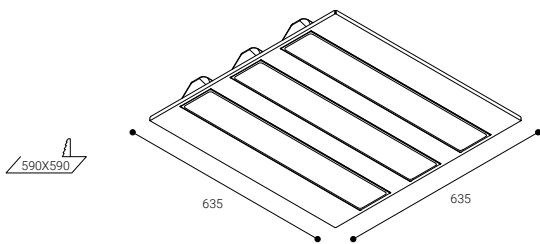
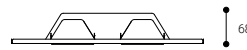
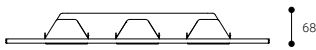

## Plasterboard ceiling mounted

### © MICROPRISMATIC DIFFUSER

	K	REF.	W	LUMEN			REF. DALI
IP 20-44	3000	NM33B	36 W	5100 lm	○	2,9	NM33DB
UGR 16	4000	NM34B	36 W	5550 lm	○	2,9	NM34DB

	K	REF.	W	LUMEN			REF. DALI
IP 20-44	3000	NM43B	48 W	6800 lm	○	2,9	NM43DB
UGR 16	4000	NM44B	48 W	7400 lm	○	2,9	NM44DB

○ RAL9016

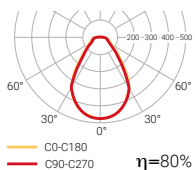

DALI Compatible with NormaLINK

360 Customization options available



# Nassel S

Surface ceiling mounted



60000 h. L70B10 | CRI >80 | 73° | Efficiency (%) 80,3

Photobiological safety

RG0 Risk free

\*Time under 3h.

Go to page 443 to learn more

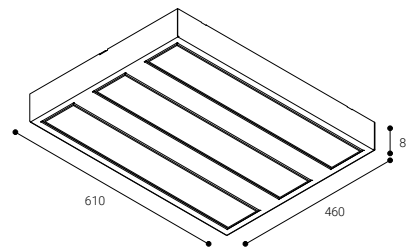
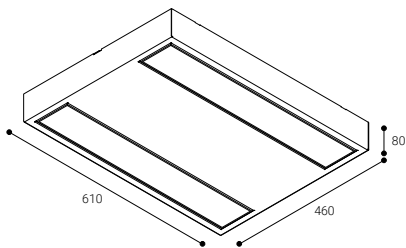

## © MICROPRISMATIC DIFFUSER

	K	REF.	W	LUMEN			REF. DALI
IP 30	3000	<b>NA23B</b>	24 W	3400 lm		4,8	<b>NA23DB</b>
UGR 16	4000	<b>NA24B</b>	24 W	3700 lm		4,8	<b>NA24DB</b>

	K	REF.	W	LUMEN			REF. DALI
IP 30	3000	<b>NA33B</b>	36 W	5100 lm		4,8	<b>NA33DB</b>
UGR 16	4000	<b>NA34B</b>	36 W	5550 lm		4,8	<b>NA34DB</b>

○ RAL9016

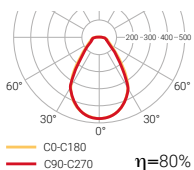

Compatible with NormaliNK

Customization options available

# Nassel S

Surface ceiling mounted



60000 h.  
L70B10

CRI  
>80

73°

Efficiency (%)  
80,3

Photobiological safety

RG0 **0** Risk free

\*Time under 3 h.

Go to page 443 to learn more

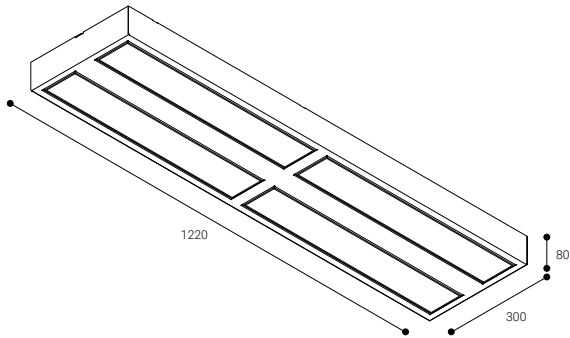

	K	REF.	W	LUMEN			REF. DALI
IP <b>30</b>	3000	<b>NA43B</b>	48 W	6800 lm		4,8	<b>NA43DB</b>
UGR <b>16</b>	4000	<b>NA44B</b>	48 W	7400 lm		4,8	<b>NA44DB</b>

# Nassel S

Suspended ceiling mounted



60000 h. L70B10 | CRI >80 | 73° | Efficiency (%) 80,3

Photobiological safety

RG0 Risk free

\*Time under 3h.

Go to page 443 to learn more

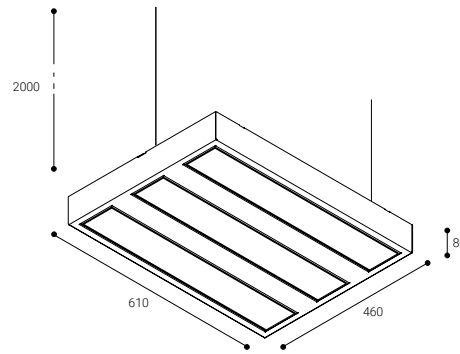
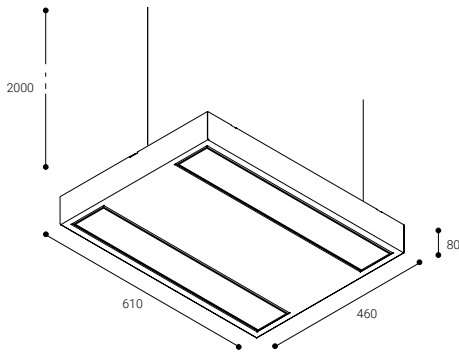

## © MICROPRISMATIC DIFFUSER

	K	REF.	W	LUMEN			REF. DALI
IP 20	3000	<b>NAS23B</b>	24 W	3400 lm	○	4,8	<b>NAS23DB</b>
UGR 16	4000	<b>NAS24B</b>	24 W	3700 lm	○	4,8	<b>NAS24DB</b>

	K	REF.	W	LUMEN			REF. DALI
IP 20	3000	<b>NAS33B</b>	36 W	5100 lm	○	4,8	<b>NAS33DB</b>
UGR 16	4000	<b>NAS34B</b>	36 W	5550 lm	○	4,8	<b>NAS34DB</b>

○ RAL9016

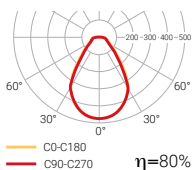

**DALI** Compatible with **NormaLINK**

**360** Customization options available



# Nassel S

Suspended ceiling mounted



60000 h.  
L70B10

CRI  
>80

73°

Efficiency (%)  
80,3

Photobiological safety

RG0 **0** Risk free

\*Time under 3 h.

Go to page 443 to learn more

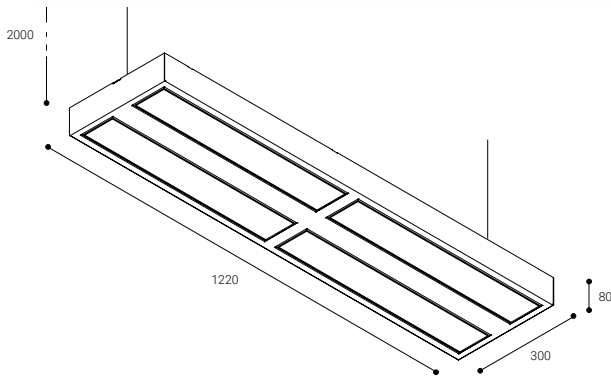

	K	REF.	W	LUMEN			REF. DALI
IP <b>20</b>	3000	<b>NAS43B</b>	48 W	6800 lm	○	4,8	<b>NAS43DB</b>
UGR <b>16</b>	4000	<b>NAS44B</b>	48 W	7400 lm	○	4,8	<b>NAS44DB</b>

# Luzerna Avant

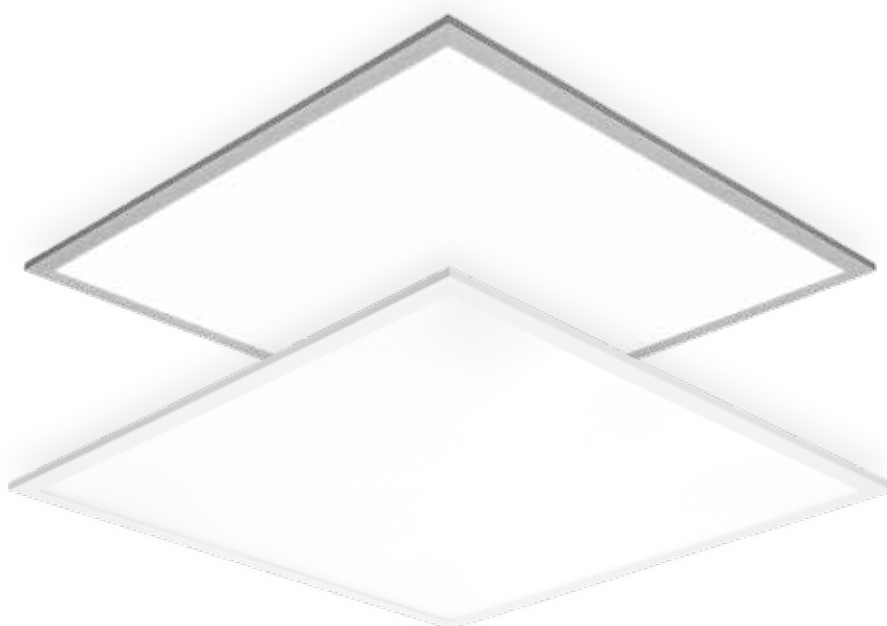

New Normalit luminaire for modular ceilings, available in three different sizes: 600x600, 1200x300 and 1200x600.

To be installed in plasterboard ceilings, suspended or surface mounted with accessories.

Available in:

**SALUZ**<sup>®</sup>

## Two versions

UGR  
**19**

Diffuser with  
Technical PS

UGR  
**16**

PMMA  
microprismatic diffuser

Ceiling recessed mounted



# Luzerna Avant range, customized to fit your needs

## Special decorative executions

Personalize Luzerna luminaires by customizing LED Diffusers with high-quality printed images, without any limitations in design. Get a perfect finish and transform the space with an original and impressive line of decorative lighting, with all the technical features of the Luzerna Avant range. [Request information.](#)





## Luzerna Avant

Installation	Recessed in modular ceiling
	Recessed in plasterboard ceiling with accessories
	Surface mounted with accessories
	Suspended with accessories

Diffuser	⊙ ⊙
----------	-----

Light source	LED
--------------	-----

Photobiological safety	0
------------------------	---

UGR	16   19
-----	---------

CRI	>80
-----	-----

MacAdam ellipse	3
-----------------	---

Beam angle range	91   114
------------------	----------

Power range (W)	32-64
-----------------	-------

Colour temperature (°K)	2700   3000   4000   5000   6500
-------------------------	----------------------------------

Light range	4320-10280
-------------	------------

Power factor	0,96
--------------	------

Efficiency (%)	70,9   77,74
----------------	--------------

Expectancy	50000 h L70B10
------------	----------------

DALI Option	✓
-------------	---

Continuous operation 24h	✓
--------------------------	---

IP	20-54
----	-------

Class	II
-------	----

Ideal cut out (mm)	600x600   1200x300   1200x600
--------------------	-------------------------------

Energy efficiency	B   C   D
-------------------	-----------

⊙ Technical PS diffuser

⊙ PMMA microprismatic diffuser

**CRI 360** | For other CRI values, please contact us.



Please request technical specifications of all the luminaires or visit our website.

NUMBER OF FITTINGS NEEDED IN A STANDARD INSTALLATION

### LX34

	200 lx	300 lx	500 lx
50 m <sup>2</sup>	3	4	6
100 m <sup>2</sup>	5	8	14
150 m <sup>2</sup>	7	12	20
200 m <sup>2</sup>	10	16	26

Height used for the calculation: 2,8 m

# Luzerna Avant

Ceiling recessed mounted

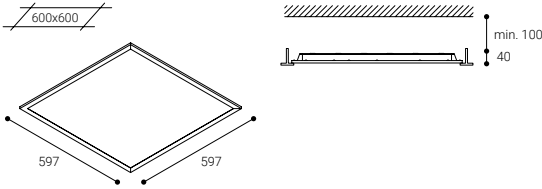

50000 h.  
L70B10

CRI  
>80

91-114°

Efficiency (%)  
77,74 Diffuser PS  
70,9 Diffuser PMMA

Photobiological safety

RG0 **0** Risk free

\*Time under 3 h.

Go to page 443 to learn more



## TECHNICAL PS DIFFUSER

	K	REF.	W	LUMEN				REF. DALI
IP 20-54	3000	LX33B	32 W	4320 lm	○	2,9	6	LX33DB
UGR 19	4000	LX34B	32 W	5140 lm	○	2,1	6	LX34DB
	5000	LX35B	32 W	5140 lm	○	2,9	6	LX35DB

## PMMA MICROPRISMATIC DIFFUSER

	K	REF.	W	LUMEN				REF. DALI
IP 20-54	3000	LX33GB	32 W	4320 lm	○	2,2	6	LX33DGB
UGR 16	4000	LX34GB	32 W	5140 lm	○	2,2	6	LX34DGB
	5000	LX35GB	32 W	5140 lm	○	2,2	6	LX35DGB

○ RAL9016

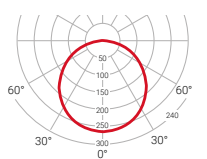

— C0-C180  
— C90-C270  $\eta=77,74\%$

Compatible with

○ RAL9016

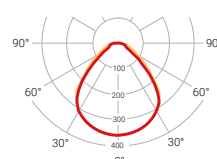

— C0-C180  
— C90-C270  $\eta=70,9\%$

Compatible with

# Luzerna Avant

Ceiling recessed mounted

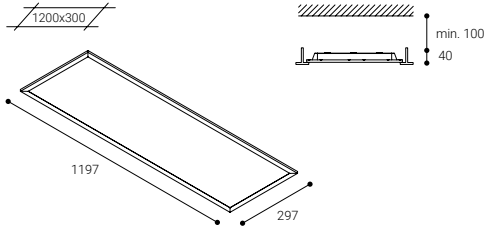

50000 h.  
L70B10

CRI  
>80

91-114°

Efficiency (%)  
77,74 PS diffuser  
70,9 PMMA diffuser

Photobiological safety

RG0 Risk free

\*Time under 3 h.

Go to page 443 to learn more



## TECHNICAL PS DIFFUSER

	K	REF.	W	LUMEN			REF. DALI
IP 20-54	3000	LX43B	32 W	4320 lm		2,9	6 LX43DB
UGR 19	4000	LX44B	32 W	5140 lm		2,9	6 LX44DB
	5000	LX45B	32 W	5140 lm		2,9	6 LX45DB

## PMMA MICROPRISMATIC DIFFUSER

	K	REF.	W	LUMEN			REF. DALI
IP 20-54	3000	LX43GB	32 W	4320 lm		2,2	6 LX43DGB
UGR 16	4000	LX44GB	32 W	5140 lm		2,2	6 LX44DGB
	5000	LX45GB	32 W	5140 lm		2,2	6 LX45DGB

RAL9016

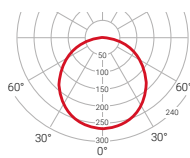

— C0-C180  
— C90-C270  $\eta=77,74\%$

Compatible with **NormaLINK**

RAL9016

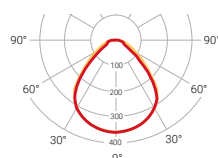

— C0-C180  
— C90-C270  $\eta=70,9\%$

Compatible with **NormaLINK**

# Luzerna Avant

Ceiling recessed mounted

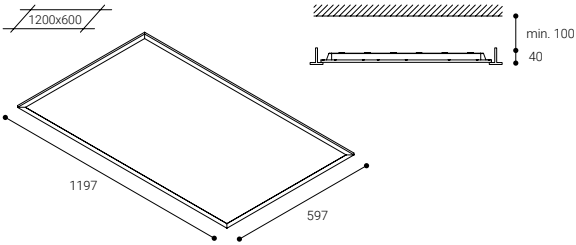

50000 h.  
L70B10

CRI  
>80

91-114°

Efficiency (%)  
77,74 PS diffuser  
70,9 PMMA diffuser

Photobiological safety

RG0 **0** Risk free

Go to page 443 to learn more



## © TECHNICAL PS DIFFUSER

	K	REF.	W	LUMEN				REF. DALI
IP 20-54	3000	LX53B	64 W	8640 lm	○	5,8	3	LX53DB
UGR 19	4000	LX54B	64 W	10280 lm	○	5,8	3	LX54DB
	5000	LX55B	64 W	10280 lm	○	5,8	3	LX55DB

## © PMMA MICROPRISMATIC DIFFUSER

	K	REF.	W	LUMEN				REF. DALI
IP 20-54	3000	LX53GB	64 W	8640 lm	○	2,2	3	LX53DGB
UGR 16	4000	LX54GB	64 W	10280 lm	○	2,2	3	LX54DGB
	5000	LX55GB	64 W	10280 lm	○	2,2	3	LX55DGB

○ RAL9016

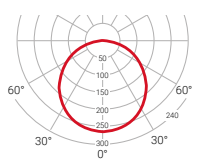

— C0-C180  
— C90-C270  $\eta=77,74\%$

Compatible with

○ RAL9016

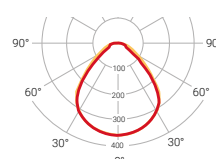

— C0-C180  
— C90-C270  $\eta=70,9\%$

Compatible with



# Luzerna Avant

---

ACCESSORIES

<b>LX3M</b>	Kit for plasterboard recessed installation 600x600
<b>LX4M</b>	Kit for plasterboard recessed installation 1200x300
<b>LX5M</b>	Kit for plasterboard recessed installation 1200x600
<b>LXKS</b>	Kit for suspended installation (all models)
<b>LXS3B</b>	Kit for surface mounted 600x600
<b>LXS4B</b>	Kit for surface mounted 1200x300
<b>LXS5B</b>	Kit for surface mounted 1200x600





SaLuz® is the technology from Normalit that creates healthy, comfortable and efficient environments

SaLuz® luminaires have been inspired by the sun to adapt to the biological cycles.

**No network or external device connection is required.**

Versions:

SaLuz® **Self-contained**

Once the luminaire has been connected to mains, it automatically modifies the intensity and the tone of the light all over the day.

SaLuz® **Tunable white**

COMPATIBLE WITH NORMALINK

This version makes it possible to modify circadian cycles from Normalink in remote, and also to adapt them to the specific needs of the project.



SaLuz® Video  
and more information

SaLuz® is a registered Trademark. SaLuz® technology has been protected by utility model number 201931533.

# Luzerna Avant saLuz®

Ceiling recessed mounted

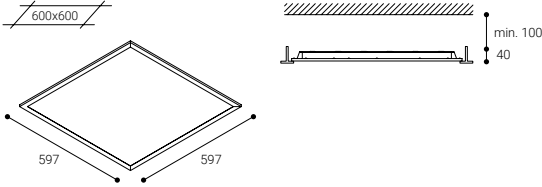

50000 h.  
L70B10

CRI  
>80

91-114°

Efficiency (%)  
77,74 PS diffuser  
70,9 PMMA diffuser

Photobiological safety

RG0 0 Risk free

\*Time under 3 h.

Go to page 443 to learn more



saLuz®

TECHNICAL PS DIFFUSER

	K	REF.		W	LUMEN		
IP	2700-6500	LX3ZB	●	32 W	4725 lm	○	2,2
20-54		LX3TWB	●	32 W	4725 lm	○	2,2
UGR							19

saLuz®

PMMA MICROPRISMATIC DIFFUSER

	K	REF.		W	LUMEN		
IP	2700-6500	LX3ZGB	●	32 W	4725 lm	○	2,2
20-54		LX3TWGB	●	32 W	4725 lm	○	2,2
UGR							16

○ RAL9016

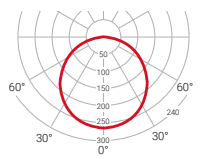

— C0-C180  
— C90-C270  
 $\eta=77,74\%$

● saLuz® coolwhite  
● saLuz® warmwhite  
COMPATIBLE WITH NORMALINK

○ RAL9016

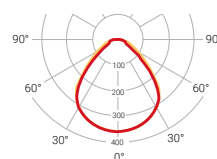

— C0-C180  
— C90-C270  
 $\eta=70,9\%$

● saLuz® coolwhite  
● saLuz® warmwhite  
COMPATIBLE WITH NORMALINK

# Luzerna Avant **salUZ**®

Ceiling recessed mounted

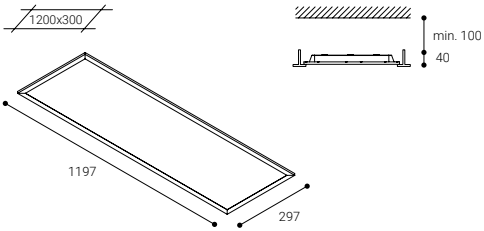

50000 h.  
L70B10

CRI  
>80

91-114°

Efficiency (%)  
77,74 PS diffuser  
70,9 PMMA diffuser

Photobiological safety

RG0 **0** Risk free

\*Time under 3 h.

Go to page 443 to learn more



## © TECHNICAL PS DIFFUSER

	K	REF.		W	LUMEN		
IP 20-54	2700-6500	LX4ZB	●	32 W	4725 lm	○	2,2
		LX4TWB	●	32 W	4725 lm	○	2,2
UGR 19							

## © PMMA MICROPRISMATIC DIFFUSER

	K	REF.		W	LUMEN		
IP 20-54	2700-6500	LX4ZGB	●	32 W	4725 lm	○	2,2
		LX4TWGB	●	32 W	4725 lm	○	2,2
UGR 16							

○ RAL9016

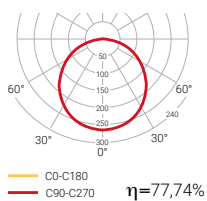

● salUZ\* self-contained  
● salUZ\* compatible with NORMALINK

○ RAL9016

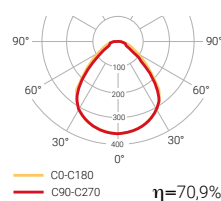

● salUZ\* self-contained  
● salUZ\* compatible with NORMALINK

# Luzerna Avant saLuz®

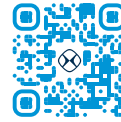

SaLuz® Video and more information

Ceiling recessed mounted

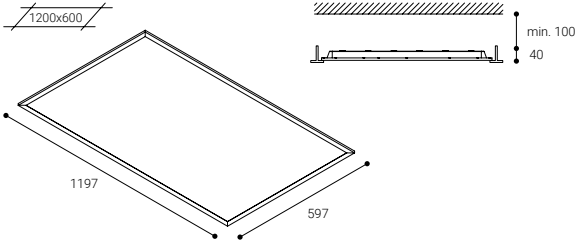

50000 h.  
L70B10

CRI  
>80

91-114°

Efficiency (%)  
77,74 PS diffuser  
70,9 PMMA diffuser

Photobiological safety

RG0 Risk free

\*Time under 3 h.

Go to page 443 to learn more



## © TECHNICAL PS DIFFUSER

	K	REF.		W	LUMEN		
IP	2700-6500	LX5ZB	●	64 W	9450 lm	○	2,2
20-54		LX5TWB	●	64 W	9450 lm	○	2,2
UGR							19

## © PMMA MICROPRISMATIC DIFFUSER

	K	REF.		W	LUMEN		
IP	2700-6500	LX5ZGB	●	64 W	9450 lm	○	4,4
20-54		LX5TWGB	●	64 W	9450 lm	○	4,4
UGR							16

○ RAL9016

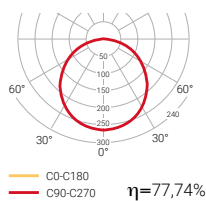

○ RAL9016

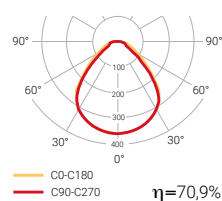

# SeaLED

IP65 

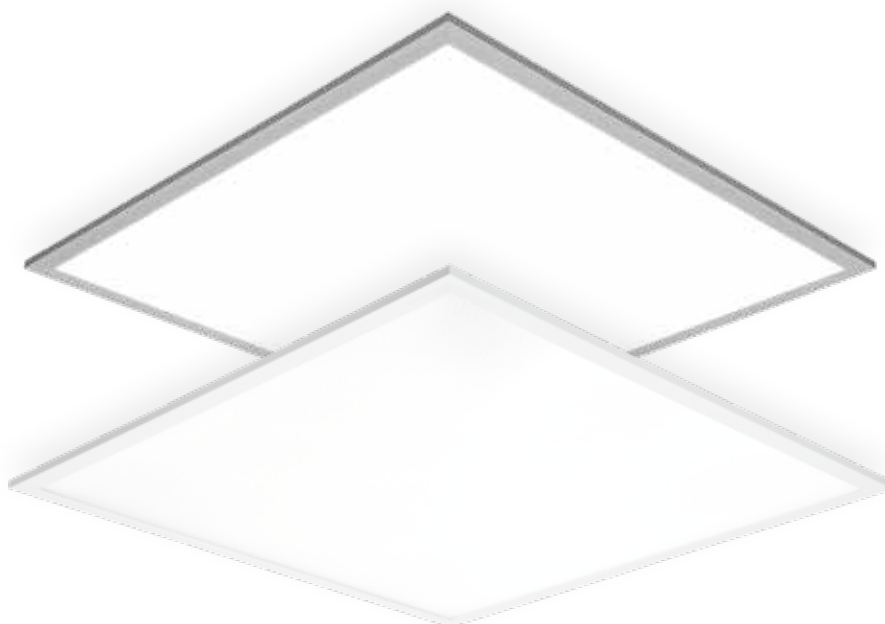

New LED lighting IP65 by Normalit. Three versions available:  
600x600, 1200x300 and 1200x600.

Its IP65 allows its use in clean rooms.

Specifically designed to be used in technical ceilings.

Available in:

**SALUZ**<sup>®</sup>

Two versions:

UGR  
**19**

Diffuser with  
technical PS

UGR  
**16**

PMMA  
microprismatic diffuser

Ceiling recessed mounted





## SeaLED

Installation	Recessed in modular ceiling
	Recessed in plasterboard ceiling with accessories
	Surface mounted with accessories
	Suspended with accessories

Diffuser	☉ ☉
Light source	LED
Photobiological safety	0
UGR	16   19
CRI	>80
MacAdam ellipse	3
Beam angle range	91-114
Power range (W)	32-64
Colour temperature (°K)	2700   3000   4000   6500
Light range	4320-10280
Power factor	0,96
Efficiency (%)	70,9   77,74
Expectancy	50000 h L70B10
DALI Option	✓
Continuous operation 24h	✓
IP	20-65
Class	II
Ideal cut out (mm)	600x600   1200x300   1200x600
Energy efficiency	B   C   D

☉ Technical PS diffuser

☉ PMMA microprismatic diffuser

Version  
**saLuz**<sup>®</sup>  
 page 213



Please request technical specifications of all the luminaires or visit our website.

**+** ANTIBACTERIAL FINISHING AVAILABLE

# SeaLED

Ceiling recessed mounted

LED CE RoHS

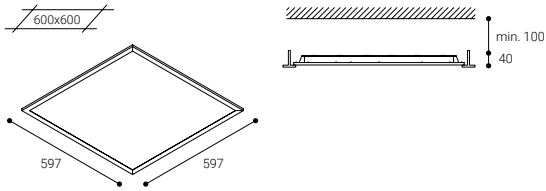

50000 h.  
L70B10

CRI  
>80

114° PS diffuser  
91° PMMA diffuser

Efficiency (%)  
77,74 PS diffuser  
70,90 PMMA diffuser

Photobiological safety

RG0 0 Risk free

\*Time under 3h

Go to page 443 to learn more



## TECHNICAL PS DIFFUSER

	K	REF.	W	LUMEN			REF. DALI
IP 20-65	3000	LXI33B	32 W	4320 lm	○	2,2	LXI33DB
UGR 19	4000	LXI34B	32 W	5140 lm	○	2,2	LXI34DB

## PMMA MICROPRISMATIC DIFFUSER

	K	REF.	W	LUMEN			REF. DALI
IP 20-65	3000	LXI33GB	32 W	4320 lm	○	2,2	LXI33DGB
UGR 16	4000	LXI34GB	32 W	5140 lm	○	2,2	LXI34DGB

○ RAL9016

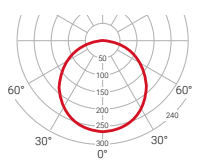

— C0-C180  
— C90-C270  $\eta=77,74\%$

Compatible with

○ RAL9016

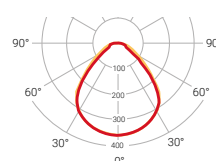

— C0-C180  
— C90-C270  $\eta=70,9\%$

Compatible with



# SeaLED

Ceiling recessed mounted

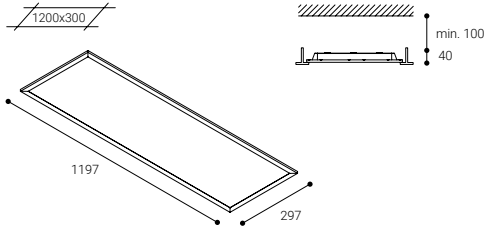

50000 h.  
L70B10

CRI  
>80

114° PS diffuser  
91° PMMA diffuser

Efficiency (%)  
77,74 PS diffuser  
70,90 PMMA diffuser

Photobiological safety

RG0 **0** Risk free

\*Time under 3 h.

Go to page 443 to learn more



## © TECHNICAL PS DIFFUSER

	K	REF.	W	LUMEN			REF. DALI
IP 20-65	3000	LXI43B	32 W	4320 lm		2,2	LXI43DB
UGR 19	4000	LXI44B	32 W	5140 lm		2,2	LXI44DB

## © PMMA MICROPRISMATIC DIFFUSER

	K	REF.	W	LUMEN			REF. DALI
IP 20-65	3000	LXI43GB	32 W	4320 lm		2,2	LXI43DGB
UGR 16	4000	LXI44GB	32 W	5140 lm		2,2	LXI44DGB

RAL9016

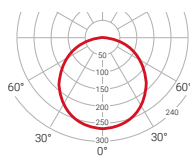

— C0-C180  
— C90-C270  $\eta=77,74\%$



RAL9016

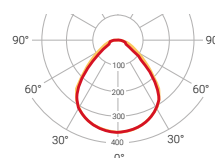

— C0-C180  
— C90-C270  $\eta=70,9\%$



# SeaLED

Ceiling recessed mounted

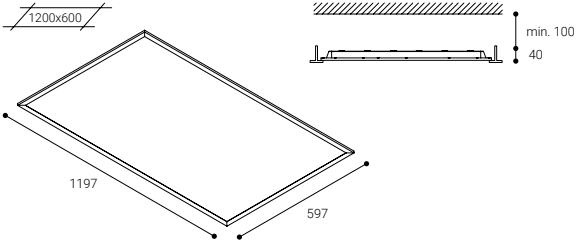
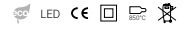

50000 h.  
L70B10

CRI  
>80

114° PS diffuser  
91° PMMA diffuser

Efficiency (%)  
77,74 PS diffuser  
70,90 PMMA diffuser

Photobiological safety

RG0 0 Risk free

\*Time under 3h

Go to page 443 to learn more



## TECHNICAL PS DIFFUSER

	K	REF.	W	LUMEN			REF. DALI
IP 20-65	3000	LXI53B	64 W	8640 lm	○	4,4	LXI53DB
UGR 19	4000	LXI54B	64 W	10280 lm	○	4,4	LXI54DB

## PMMA MICROPRISMATIC DIFFUSER

	K	REF.	W	LUMEN			REF. DALI
IP 20-65	3000	LXI53GB	64 W	8640 lm	○	4,4	LXI53DGB
UGR 16	4000	LXI54GB	64 W	10280 lm	○	4,4	LXI54DGB

○ RAL9016

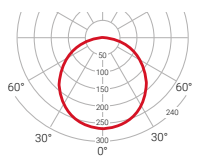

— C0-C180  
— C90-C270  $\eta=77,74\%$



○ RAL9016

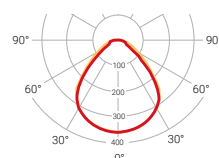

— C0-C180  
— C90-C270  $\eta=70,9\%$



---

ACCESSORIES

<b>LX3M</b>	Kit for plasterboard recessed installation 600x600
<b>LX4M</b>	Kit for plasterboard recessed installation 1200x300
<b>LX5M</b>	Kit for plasterboard recessed installation 1200x600
<b>LXKS</b>	Kit for suspended installation (all models)
<b>LXS3B</b>	Kit for surface mounted 600x600
<b>LXS4B</b>	Kit for surface mounted 1200x300
<b>LXS5B</b>	Kit for surface mounted 1200x600



# SaLUZ®

Technology inspired by the sun

SaLuz® is the technology from Normalit that creates healthy, comfortable and efficient environments

SaLuz® luminaires have been inspired by the sun to adapt to the biological cycles.

**No network or external device connection is required.**

Versions:

SaLUZ® Self-contained

Once the luminaire has been connected to mains, it automatically modifies the intensity and the tone of the light all over the day.

SaLUZ® Tunable white

COMPATIBLE WITH NORMALINK

This version makes it possible to modify circadian cycles from Normalink in remote, and also to adapt them to the specific needs of the project.



SaLuz® Video  
and more information

SaLuz® is a registered Trademark. SaLuz® technology has been protected by utility model number 201931533.

# SeaLED saLUZ®

Ceiling recessed mounted

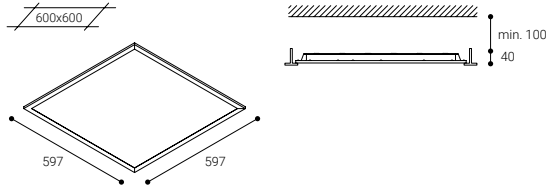

50000 h.  
L70B10

CRI  
>80

114° PS diffuser  
91° PMMA diffuser

Efficiency (%)  
77,74 PS diffuser  
70,90 PMMA diffuser

Photobiological safety

RG0 **0** Risk free

\*Time under 3 h.

Go to page 443 to learn more



## saLUZ® TECHNICAL PS DIFFUSER

	K	REF.		W	LUMEN		
IP 20-65	2700-6500	LX13ZB	●	32 W	4725 lm	○	2,2
		LX13TWB	●	32 W	4725 lm	○	2,2
UGR 19							

## saLUZ® PMMA MICROPRISMATIC DIFFUSER

	K	REF.		W	LUMEN		
IP 20-65	2700-6500	LX13ZGB	●	32 W	4725 lm	○	2,2
		LX13TWGB	●	32 W	4725 lm	○	2,2
UGR 16							

○ RAL9016

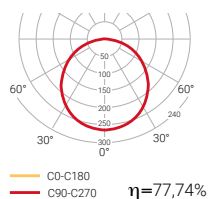

● saLUZ® cool-white  
● saLUZ® warm-white  
COMPATIBLE WITH NORMALINK

○ RAL9016

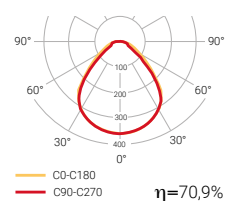

● saLUZ® cool-white  
● saLUZ® warm-white  
COMPATIBLE WITH NORMALINK

# SeaLED salUZ®

Ceiling recessed mounted

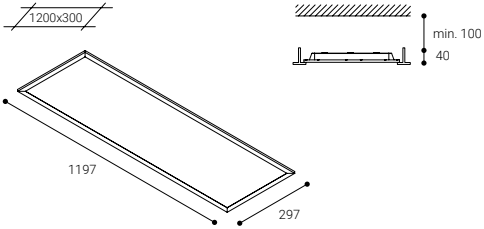
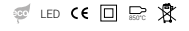

50000 h.  
L70B10

CRI  
>80

114° PS diffuser  
91° PMMA diffuser

Efficiency (%)  
77,74 PS diffuser  
70,90 PMMA diffuser

Photobiological safety

RG0 0 Risk free

\*Time under 3h

Go to page 443 to learn more



## TECHNICAL PS DIFFUSER

	K	REF.		W	LUMEN		
IP 20-54	2700-6500	LX14ZB	●	32 W	4725 lm	○	2,2
		LX14TWB	●	32 W	4725 lm	○	2,2
UGR 19							

## PMMA MICROPRISMATIC DIFFUSER

	K	REF.		W	LUMEN		
IP 20-54	2700-6500	LX14ZGB	●	32 W	4725 lm	○	2,2
		LX14TWGB	●	32 W	4725 lm	○	2,2
UGR 16							

○ RAL9016

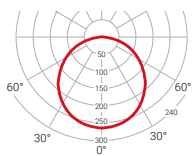

— C0-C180  
— C90-C270  $\eta=77,74\%$

● salUZ® self-contained  
● salUZ® compatible with NORMALiK

○ RAL9016

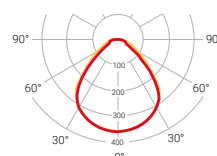

— C0-C180  
— C90-C270  $\eta=70,9\%$

● salUZ® self-contained  
● salUZ® compatible with NORMALiK

# SeaLED saLUZ®

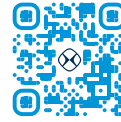

SaLuz® Video  
and more information

Ceiling recessed mounted

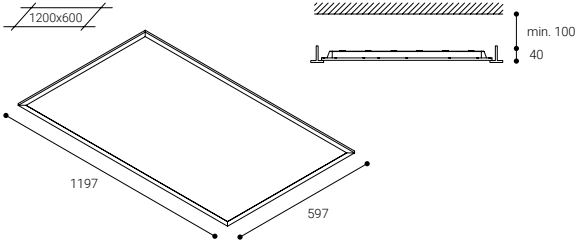

50000 h.  
L70B10

CRI  
>80

114° PS diffuser  
91° PMMA diffuser

Efficiency (%)  
77,74 PS diffuser  
70,90 PMMA diffuser

Photobiological safety

RG0 **0** Risk free

\*Time under 3 h.

Go to page 443 to learn more



## © TECHNICAL PS DIFFUSER

	K	REF.		W	LUMEN		
IP	2700-6500	LXI5ZB	●	64 W	9450 lm	○	4,4
20-54		LXI5TWB	●	64 W	9450 lm	○	4,4
UGR							19

## © PMMA MICROPRISMATIC DIFFUSER

	K	REF.		W	LUMEN		
IP	2700-6500	LXI5ZGB	●	64 W	9450 lm	○	4,4
20-54		LXI5TWGB	●	64 W	9450 lm	○	4,4
UGR							16

○ RAL9016

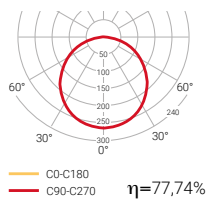

● saLUZ® coolwhite  
● saLUZ® warmwhite  
COMPATIBLE WITH NORMALINK

○ RAL9016

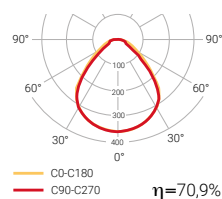

● saLUZ® coolwhite  
● saLUZ® warmwhite  
COMPATIBLE WITH NORMALINK

# Clean rooms







Alba  
**218**

# Alba



Normalit's new tight fit LED lighting has been specifically designed for healthcare, food, aerospace, microelectronics facilities, etc., and ideal for clean rooms and high-tech environments.

Designed for recessed installation in plasterboard ceilings.

The full LuzernaAvant and Nassel lighting ranges can be supplied using the ALBA system.

---

Two versions:

**SBNX System**  
Alba/Nassel Avant

**SBLX System**  
Alba/Luzerna Avant

Ceiling recessed mounted



Photography: Natalia Michelena Photo. Architecture: Verónica Durán Sela

## Alba SBNX

## Alba SBLX

Installation	Recessed to plasterboard ceiling	Recessed to plasterboard ceiling
Diffuser	⊙	⊙ ⊙
Light source	LED	LED
Photobiological safety	0	0
UGR	16	16   19
CRI	>80	>80
MacAdam ellipse	3	3
Beam angle range	77	91   114
Power range (W)	27	32
Colour temperature (°K)	3000   4000	3000   4000
Light range	4800-5000	4320-5140
Power factor	0,95	0,96
Efficiency (%)	70,5	75,2
Expectancy	72000 h L70B10	50000 h L70B10
DALI Option	✓	✓
Continuous operation 24h	✓	✓
IP	66	66
Class	I	I
Frame and body	Aluminium extrusion	Aluminium extrusion
Energy efficiency	A   B	B   D

⊙ Without diffuser   ⊙ PMMA microprismatic diffuser   ⊙ Technical PS diffuser

**CRI 360** | For other CRI values, please contact us.



Please request technical specifications of all the luminaires or visit our website.

**+** ANTIBACTERIAL FINISHING AVAILABLE

# Alba / SBNX

Ceiling recessed mounted

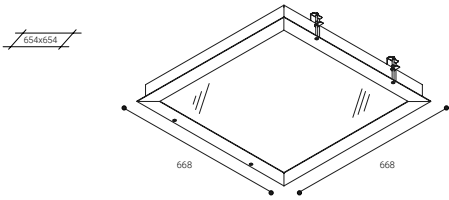
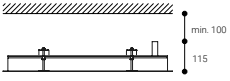

72000 h.  
L70B10

CRI  
>80

77°

Efficiency (%)  
70,5

Photobiological safety

RG0 0 Risk free

\*Time under 3h

Go to page 443 to learn more



## WITHOUT DIFFUSER

	K	REF.	W	LUMEN			REF. DALI
IP 66	3000	<b>SBNX33B</b>	27 W	4800 lm	○	14,4	<b>SBNX33DB</b>
UGR 16	4000	<b>SBNX34B</b>	27 W	5000 lm	○	14,4	<b>SBNX34DB</b>

○ RAL9016

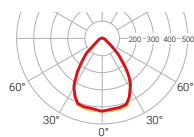

— CO-C180  
— C90-C270  $\eta=66\%$

**DALI** Compatible with **NormaLINK**

# Alba / SBNX

Ceiling recessed mounted

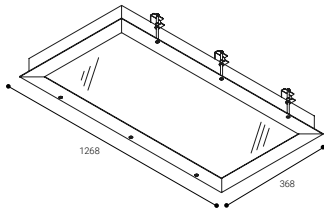
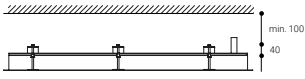

72000 h.  
L70B10

CRI  
>80

77°

Efficiency (%)  
70,5

Photobiological safety

RG0 **0** Risk free

\*Time under 3 h.

Go to page 443 to learn more

## © WITHOUT DIFFUSER

	K	REF.	W	LUMEN			REF. DALI
IP 66	3000	<b>SBNX43B</b>	27 W	4800 lm	○	13	<b>SBNX43DB</b>
UGR 16	4000	<b>SBNX44B</b>	27 W	5000 lm	○	13	<b>SBNX44DB</b>

## ○ RAL9016

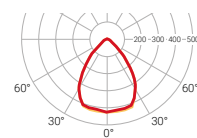

— C0-C180  
— C90-C270  $\eta=66\%$

**DALI** Compatible with **NormaLINK**

# Alba / SBLX

Ceiling recessed mounted

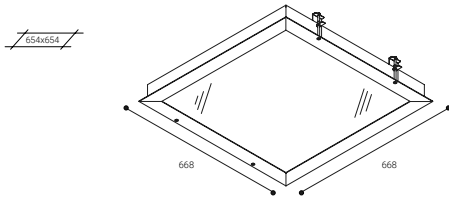
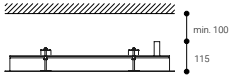

50000 h. L70B10 | CRI >80 | 91-114° | Efficiency (%) 75,2

Photobiological safety

RG0 Risk free

\*Time under 3h

Go to page 443 to learn more



## TECHNICAL PS DIFFUSER

	K	REF.	W	LUMEN			REF. DALI
IP 66	3000	<b>SBLX33B</b>	32 W	4320 lm	○	13,7	<b>SBLX33DB</b>
UGR 19	4000	<b>SBLX34B</b>	32 W	5140 lm	○	13,7	<b>SBLX34DB</b>

○ RAL9016

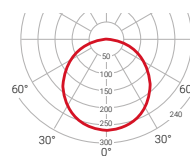

— C0-C180  
— C90-C270  $\eta=75\%$



# Alba / SBLX

Ceiling recessed mounted

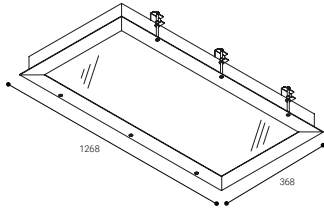
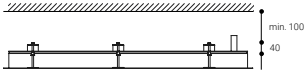

50000 h.  
L70B10

CRI  
>80

91-114°

Efficiency (%)  
75,2

Photobiological safety

RG0 **0** Risk free

\*Time under 3 h.

Go to page 443 to learn more

## © TECHNICAL PS DIFFUSER

	K	REF.	W	LUMEN			REF. DALI
IP <b>66</b>	3000	<b>SBLX43B</b>	32 W	4320 lm	○	12,3	<b>SBLX43DB</b>
UGR <b>19</b>	4000	<b>SBLX44B</b>	32 W	5140 lm	○	12,3	<b>SBLX44DB</b>

○ RAL9016

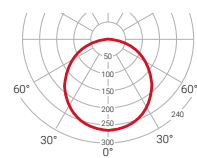

— CD-C180  
— C90-C270  $\eta=75\%$

**DALI** Compatible with **NormaLINK**

# Alba / SBLX

Ceiling recessed mounted

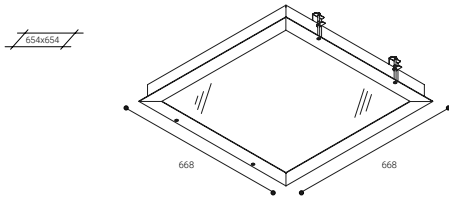
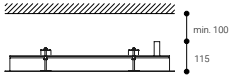
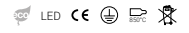

50000 h.  
L70B10

CRI  
>80

91-114°

Efficiency (%)  
75,2

Photobiological safety

RG0 0 Risk free

\*Time under 3h

Go to page 443 to learn more



## © PMMA MICROPRISMATIC DIFFUSER

	K	REF.	W	LUMEN			REF. DALI
IP <b>66</b>	3000	<b>SBLX33GB</b>	32 W	4320 lm	○	13,7	<b>SBLX33DGB</b>
UGR <b>16</b>	4000	<b>SBLX34GB</b>	32 W	5140 lm	○	13,7	<b>SBLX34DGB</b>

○ RAL9016

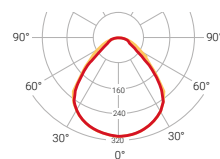

— C0-C180

— C90-C270

$\eta=69\%$

Compatible with



# Alba / SBLX

Ceiling recessed mounted

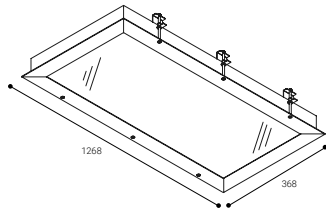
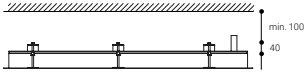

50000 h.  
L70B10

CRI  
>80

91-114°

Efficiency (%)  
75,2

Photobiological safety

RG0 **0** Risk free

\*Time under 3 h.

Go to page 443 to learn more



## © PMMA MICROPRISMATIC DIFFUSER

	K	REF.	W	LUMEN			REF. DALI
IP <b>66</b>	3000	<b>SBLX43GB</b>	32 W	4320 lm	○	12,3	<b>SBLX43DGB</b>
UGR <b>16</b>	4000	<b>SBLX44GB</b>	32 W	5140 lm	○	12,3	<b>SBLX44DGB</b>

○ RAL9016

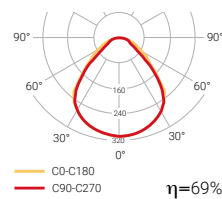

**DALI** Compatible with **NormaLINK**

# Industrial





Mark  
228



Blok Avant  
234



Blok  
240



Blok R  
244



Hermetic Avant  
246



Hermetic Line  
252



Hermetic XL  
258

# Markt



Markt is a linear lighting system for supermarkets and malls.

## Four optics

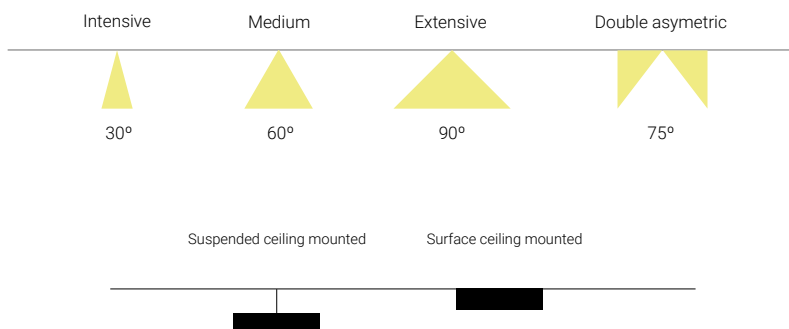

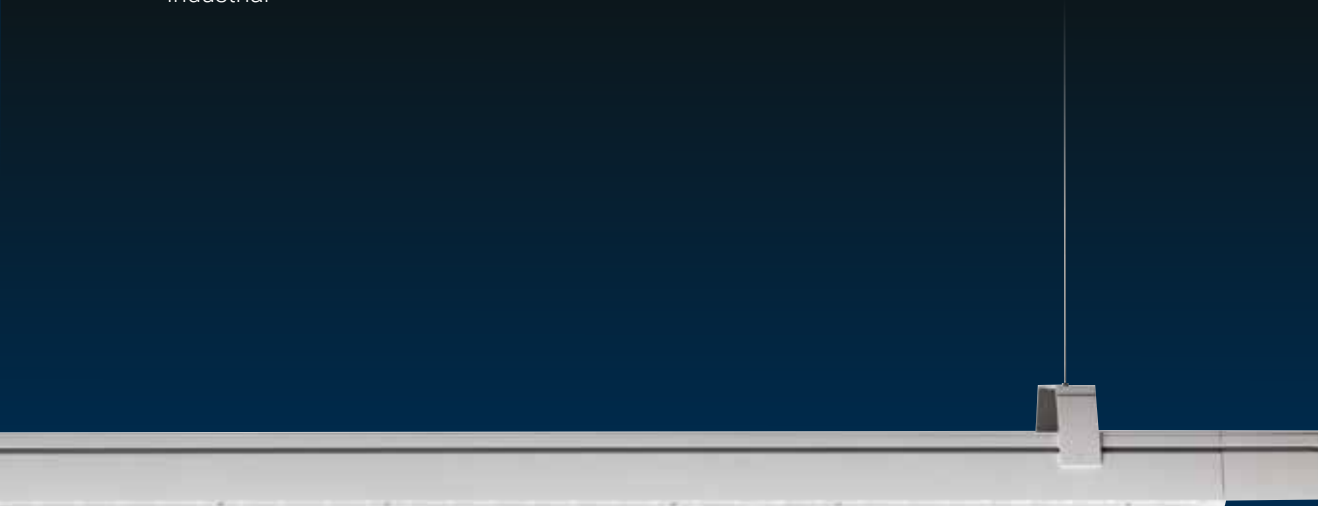

## Markt

Installation	Suspended ceiling mounted Surface ceiling mounted
Diffuser	⊕
Light source	LED
Photobiological safety	1
UGR	19
CRI	>80
MacAdam ellipse	3
Beam angle range	30-90
Power range (W)	76,44-112,7
Colour temperature (°K)	3000   4000
Light range	12320-18410
Power factor	0,95
Efficiency (%)	96,3
Expectancy	60000 h L70B10
DALI Option	✓
Continuous operation 24h	✓
IP	40
Class	I
Energy efficiency	B   C

⊕ PMMA lens

It has a connection system that allows continuous lighting line of pieces of two meters.

There are four different optics available that allows to direct the light wherever it is more convenient: Intensive (30°), medium (60°), extensive (90°) and double asymmetric (75°).



For other CRI values, please contact us.

# Markt

Suspended ceiling mounted

Surface ceiling mounted

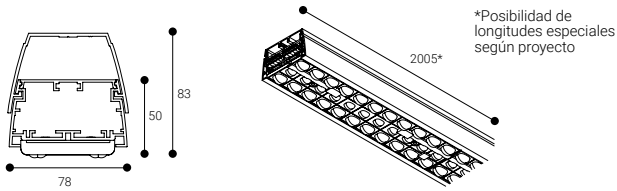
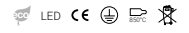

<b>60000 h.</b> L70B10	CRI <b>&gt;80</b>	<b>30-90°</b>	Efficiency (%) <b>96,3</b>	IK <b>04-06-08</b>
---------------------------	----------------------	---------------	-------------------------------	-----------------------

Photobiological safety

**RG1\*** **1** Low risk

\*Time under 3 h.

Go to page 443 to learn more



## INTENSIVE OPTICS



30°

	K	REF.	W	LUMEN			REF. DALI
IP 40	3000	<b>MK7L3SB</b>	76,44 W	12320 lm			<b>MK7L3DSB</b>
		<b>MK7H3SB</b>	112,7 W	17115 lm			<b>MK7H3DSB</b>
UGR 19	4000	<b>MK7L4SB</b>	76,44 W	13230 lm			<b>MK7L4DSB</b>
		<b>MK7H4SB</b>	112,7 W	18410 lm			<b>MK7H4DSB</b>

## MEDIUM OPTICS

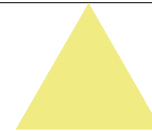

60°

	K	REF.	W	LUMEN			REF. DALI
IP 40	3000	<b>MK7L3MB</b>	76,44 W	12320 lm			<b>MK7L3DMB</b>
		<b>MK7H3MB</b>	112,7 W	17115 lm			<b>MK7H3DMB</b>
UGR 19	4000	<b>MK7L4MB</b>	76,44 W	13230 lm			<b>MK7L4DMB</b>
		<b>MK7H4MB</b>	112,7 W	18410 lm			<b>MK7H4DMB</b>

- RAL9016
- RAL9005 Replace "B" by "N" in the reference

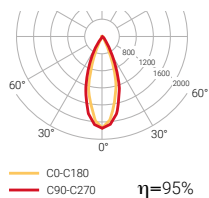

- RAL9016
- RAL9005 Replace "B" by "N" in the reference

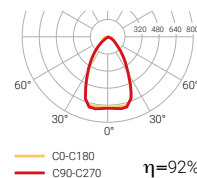

# Markt

Suspended ceiling mounted

Surface ceiling mounted

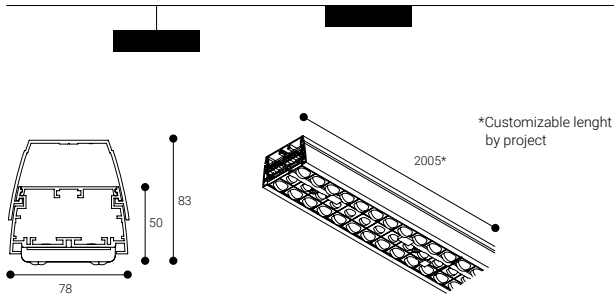

60000 h.  
L70B10

CRI  
>80

30-90°

Efficiency (%)  
96,3

IK  
04-06-08

Photobiological safety

RG1\* **1** Low risk

\*Time under 3 h.

Go to page 443 to learn more

## EXTENSIVE OPTICS



90°

	K	REF.	W	LUMEN			REF. DALI
IP 40	3000	MK7L3FB	76,44 W	12320 lm		5,1	MK7L3DFB
		MK7H3FB	112,7 W	17115 lm		5,1	MK7H3DFB
UGR 19	4000	MK7L4FB	76,44 W	13230 lm		5,1	MK7L4DFB
		MK7H4FB	112,7 W	18410 lm		5,1	MK7H4DFB

## DOUBLE OPTICS



75°

	K	REF.	W	LUMEN			REF. DALI
IP 40	3000	MK7L3YB	76,44 W	12320 lm		5,1	MK7L3DYB
		MK7H3YB	112,7 W	17115 lm		5,1	MK7H3DYB
UGR 19	4000	MK7L4YB	76,44 W	13230 lm		5,1	MK7L4DYB
		MK7H4YB	112,7 W	18410 lm		5,1	MK7H4DYB

RAL9016

RAL9005 Replace "B" by "N" in the reference

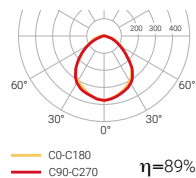

Compatible with **NormaLINK**

RAL9016

RAL9005 Replace "B" by "N" in the reference

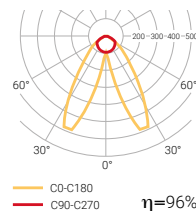

Compatible with **NormaLINK**







# Markt

ACCESSORIES

Power supply

		COLOUR
	<b>MKIB</b>	○
	<b>MKIN</b>	●
	<b>MKIDB</b>	○
	<b>MKIDN</b>	●

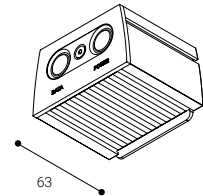

End cover

		COLOUR
	<b>MKFB</b>	○
	<b>MKFN</b>	●

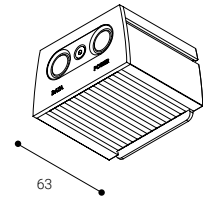

Suspension accessory

		L (m)
	<b>1029L2</b>	2
	<b>1029L4</b>	4

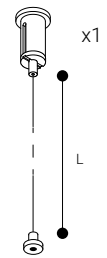

Connection box and power supply cable

		POWER SUPPLY CABLE LENGTH	COLOUR
	<b>ETC1029B</b>	2	○
	<b>ETC1029N</b>	2	●
	<b>ETC10294MB</b>	4	○
	<b>ETC10294MN</b>	4	●
	<b>ETC10295PB</b>	2	○
	<b>ETC10295PN</b>	2	●
	<b>ETC10295P4MB</b>	4	○
	<b>ETC10295P4MN</b>	4	●

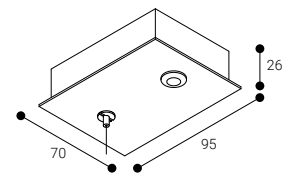

# Blok Avant



BLOK AVANT is an industrial fitting designed to light open areas. It has different illuminate to achieve a maximum save in number of luminaires needed and power consumption.

Includes analogic 1-10V regulation.

A system of interchangeable lenses and an alluminium reflector are available as accessories.

---

## Three optics

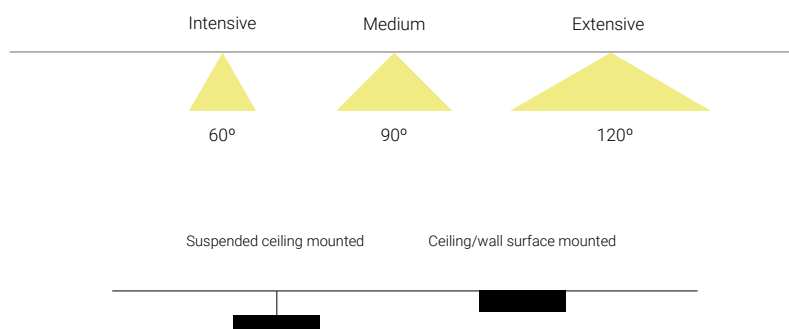

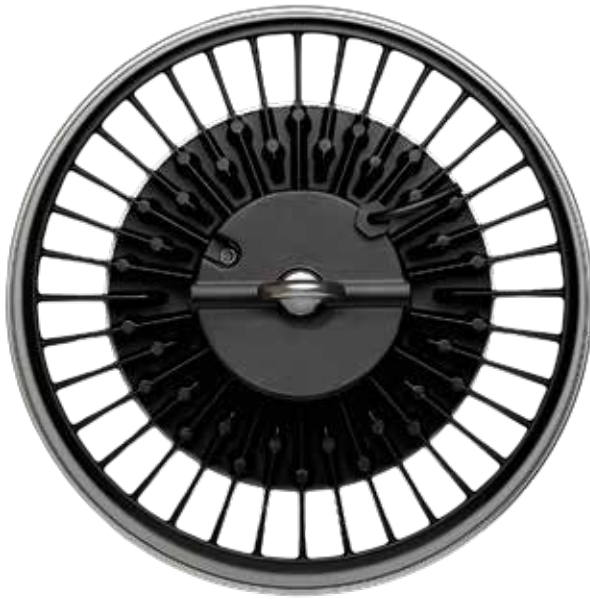

IP68



Includes an IP68 waterproof linear 3 pole connector

*IP68 two pole connector for 1-10V regulation not provided.*

## Blok Avant

**Luminaire protected against overvoltage (up to 4kV)**

Installation	Ceiling suspended (eyebolt included) Ceiling/Wall mounted (BKLN accessory for surface mounting is necessary)
Diffuser	⊙
Light source	LED
Photobiological safety	1
UGR	22
CRI	>80
MacAdam ellipse	3
Beam angle range	60-120
Power range (W)	90,9-181,8
Colour temperature (°K)	4000   5700
Light range	15000-30070
Power factor	0,95
Efficiency (%)	94,54
Expectancy	50000 h L70B10
DALI Option	—
Continuous operation 24h	✓
IP	67
Class	I
Energy efficiency	B

⊙ PMMA lens



For other CRI values, please contact us.



**ANALOG 1-10V REGULATION INCLUDED BY DEFAULT**

# Blok Avant

Suspended ceiling mounted

Ceiling/wall surface mounted

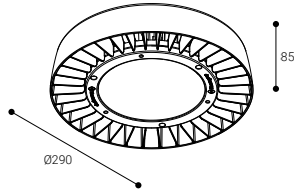

50000 h.  
L70B10

CRI  
>80

60-120°

IK  
07-08

4 kV

Photobiological safety

RG1\* **1** Low risk

\*Time under 3h.

Go to page 443 to learn more



## INTENSIVE OPTICS

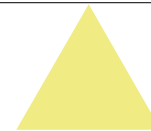

60°

	K	REF.	W	LUMEN		
IP 67	4000	BK100-4SN	90,9 W	15000 lm	●	4,1
		BK150-4SN	136,4 W	22500 lm	●	4,1
UGR 22	5700	BK200-4SN	181,8 W	30000 lm	●	4,1
		BK100-5SN	90,9 W	15030 lm	●	4,1
		BK150-5SN	136,4 W	22550 lm	●	4,1
		BK200-5SN	181,8 W	30070 lm	●	4,1

INCLUDES AN IP68 WATERPROOF LINEAR 3 POLE CONNECTOR

● RAL9011 TEXTURIZED

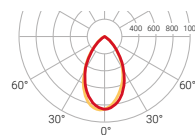

CO-C180  
C90-C270  $\eta=94\%$

# Blok Avant

Suspended ceiling mounted

Ceiling/wall surface mounted

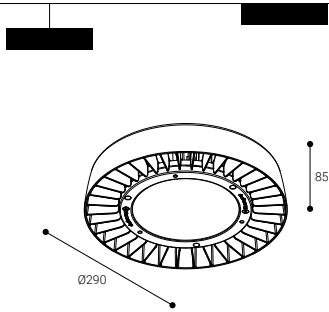

50000 h.  
L70B10

CRI  
>80

60-120°

IK  
07-08

4 kV

Photobiological safety

RG1\* **1** Low risk

\*Time under 3 h.

Go to page 443 to learn more

## MEDIUM OPTICS

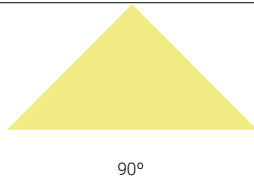

90°

	K	REF.	W	LUMEN		
IP 67	4000	BK100-4MN	90,9 W	15000 lm	●	4,1
		BK150-4MN	136,4 W	22500 lm	●	4,1
UGR 22	5700	BK200-4MN	181,8 W	30000 lm	●	4,1
		BK100-5MN	90,9 W	15030 lm	●	4,1
		BK150-5MN	136,4 W	22550 lm	●	4,1
		BK200-5MN	181,8 W	30070 lm	●	4,1

● RAL9011 TEXTURIZED

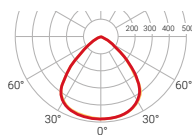

— C0-C180  
— C90-C270  $\eta=94\%$

## EXTENSIVE OPTICS



120°

	K	REF.	W	LUMEN		
IP 67	4000	BK100-4FN	90,9 W	15000 lm	●	4,1
		BK150-4FN	136,4 W	22500 lm	●	4,1
UGR 22	5700	BK200-4FN	181,8 W	30000 lm	●	4,1
		BK100-5FN	90,9 W	15030 lm	●	4,1
		BK150-5FN	136,4 W	22550 lm	●	4,1
		BK200-5FN	181,8 W	30070 lm	●	4,1

● RAL9011 TEXTURIZED

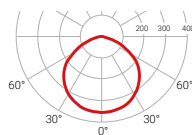

— C0-C180  
— C90-C270  $\eta=95\%$

# Blok Avant

ACCESSORIES

		COLOUR
<b>BK060L</b>	Opening angle lens 60°	
<b>BK090L</b>	Opening angle lens 90°	
<b>BK120L</b>	Transparent glass 120° opening angle	
<b>BK060R</b>	Opening angle reflector 60°	Ⓐ
<b>BK090R</b>	Opening angle reflector 90°	Ⓐ
<b>BKLN</b>	Accessory for surface mounting	●
<b>1029L2VP</b>	2 metres long suspension accessory	
<b>1029L4VP</b>	4 metres long suspension accessory	
<b>REGBORTEK2UI</b>	2 pole linear waterproof connector	

OPENING ANGLE



GLASS

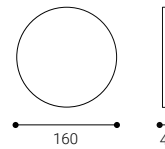

REFLECTOR

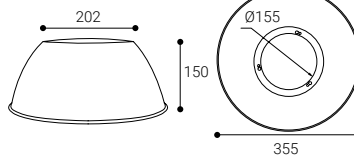

BKLN

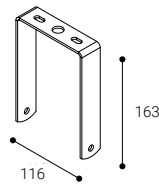

1029L2VP

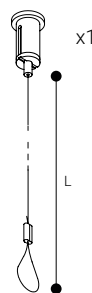

Industrial

Blok Avant + BKLN



Blok Avant + reflector



# Blok



BLOK is an industrial luminaire for use in high open spaces. Its different optics optimize the savings in the number of luminaires and the total consumption in the installation.

There are two different shapes available: square (Blok) and round (Blok R).

---

## Three optics

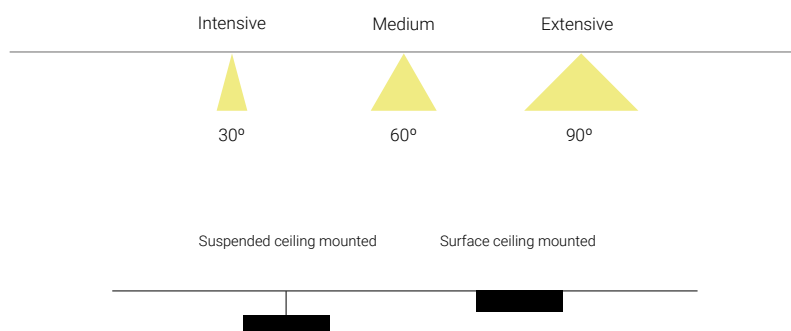





## Blok

Suspended ceiling mounted  
Surface ceiling mounted

## Blok R

Suspended ceiling mounted

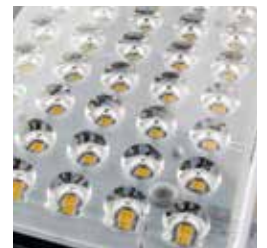

Installation		
Diffuser	⊗	⊗
Light source	LED	LED
Photobiological safety	1	1
UGR	22	22
CRI	>80	>80
MacAdam ellipse	3	3
Beam angle range	30-90	30-90
Power range (W)	154	154
Colour temperature (°K)	5000	5000
Light range	21000	21000
Power factor	0,95	0,95
Efficiency (%)	89,4	89,4
Expectancy	60000 h L70B10	60000 h L70B10
DALI Option	✓	✓
Continuous operation 24h	✓	✓
IP	67	67
IK	07	07
Class	I	I
Energy efficiency	C	C

⊗ PMMA lens

**CRI 360** | For other CRI values,  
please contact us.

# Blok

Suspended ceiling mounted

Surface ceiling mounted

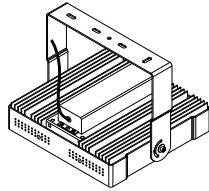
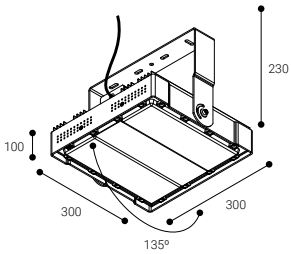

60000 h.  
L70B10

CRI  
>80

30-90°

Efficiency (%)  
89,4

IK  
07

Photobiological safety

RG1\* **1** Low risk

\*Time under 3 h.

Go to page 443 to learn more



## INTENSIVE OPTICS



30°

	K	REF. DALI	W	LUMEN		
IP	5000	<b>BKA205DSN</b>	154 W	21000 lm	●	5,6
UGR	22					

● RAL9005

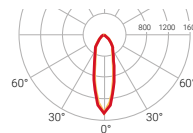

— C0-C180  
— C90-C270  $\eta=89\%$

**DALI** Compatible with **NormaLINK**

# Blok

Suspended ceiling mounted

Surface ceiling mounted

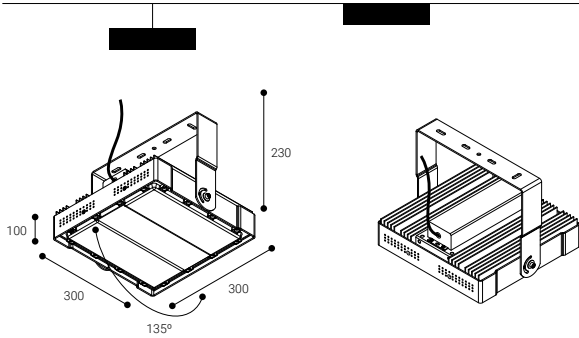

<b>60000 h.</b> L70B10	CRI <b>&gt;80</b>	<b>30-90°</b>	Efficiency (%) <b>89,4</b>	IK <b>07</b>
---------------------------	----------------------	---------------	-------------------------------	-----------------

Photobiological safety

**RG1\*** **1** Low risk

\*Time under 3 h.

Go to page 443 to learn more

## MEDIUM OPTICS

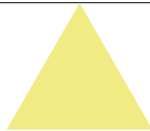

60°

	K	REF. DALI	W	LUMEN		
IP <b>67</b>	5000	<b>BKA205DMN</b>	154 W	21000 lm	●	5,6
UGR <b>22</b>						

## EXTENSIVE OPTICS

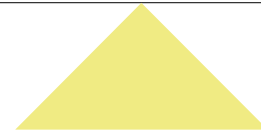

90°

	K	REF. DALI	W	LUMEN		
IP <b>67</b>	5000	<b>BKA205DFN</b>	154 W	21000 lm	●	5,6
UGR <b>22</b>						

● RAL9005

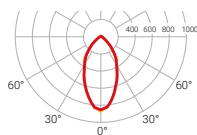

— C0-C180  
— C90-C270  $\eta=88\%$

Compatible with **NormaLINK**

● RAL9005

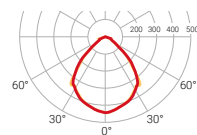

— C0-C180  
— C90-C270  $\eta=85\%$

Compatible with **NormaLINK**

# Blok R

Suspended ceiling mounted

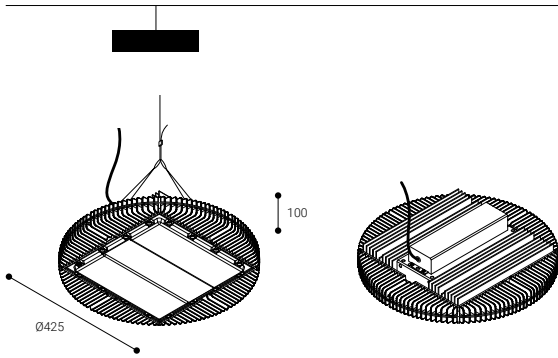

<b>60000 h.</b> L70B10	CRI <b>&gt;80</b>	<b>30-90°</b>	Efficiency (%) <b>89,4</b>	IK <b>07</b>
---------------------------	----------------------	---------------	-------------------------------	-----------------

Photobiological safety

**RG1\*** **1** Low risk

\*Time under 3h.

**Go to page 443 to learn more**



## INTENSIVE OPTICS



30°

	K	REF. DALI	W	LUMEN		
IP <b>67</b>	5000	<b>BRS205DSN</b>	154 W	21000 lm		5,6
UGR <b>22</b>						

**RAL9005**

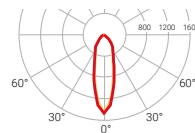

C0-C180  
C90-C270 **η=89%**

Compatible with **NormaLINK**

# Blok R

Suspended ceiling mounted

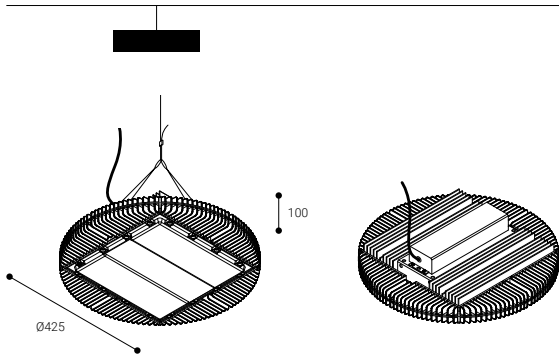

<b>60000 h.</b> L70B10	CRI <b>&gt;80</b>	<b>30-90°</b>	Efficiency (%) <b>89,4</b>	IK <b>07</b>
---------------------------	-------------------	---------------	----------------------------	--------------

Photobiological safety

**RG1\*** **1** Low risk

\*Time under 3 h.

Go to page 443 to learn more

## MEDIUM OPTICS

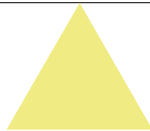

60°

	K	REF. DALI	W	LUMEN		
IP <b>67</b>	5000	<b>BRS205DMN</b>	154 W	21000 lm	●	5,6
UGR <b>22</b>						

## EXTENSIVE OPTICS

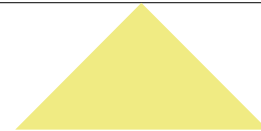

90°

	K	REF. DALI	W	LUMEN		
IP <b>67</b>	5000	<b>BRS205DFN</b>	154 W	21000 lm	●	5,6
UGR <b>22</b>						

● RAL9005

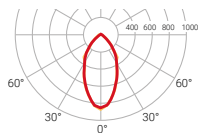

— C0-C180  
— C90-C270  $\eta=88\%$

Compatible with **NormaLINK**

● RAL9005

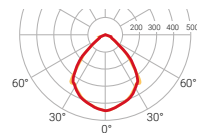

— C0-C180  
— C90-C270  $\eta=85\%$

Compatible with **NormaLINK**

# Hermetic Avant

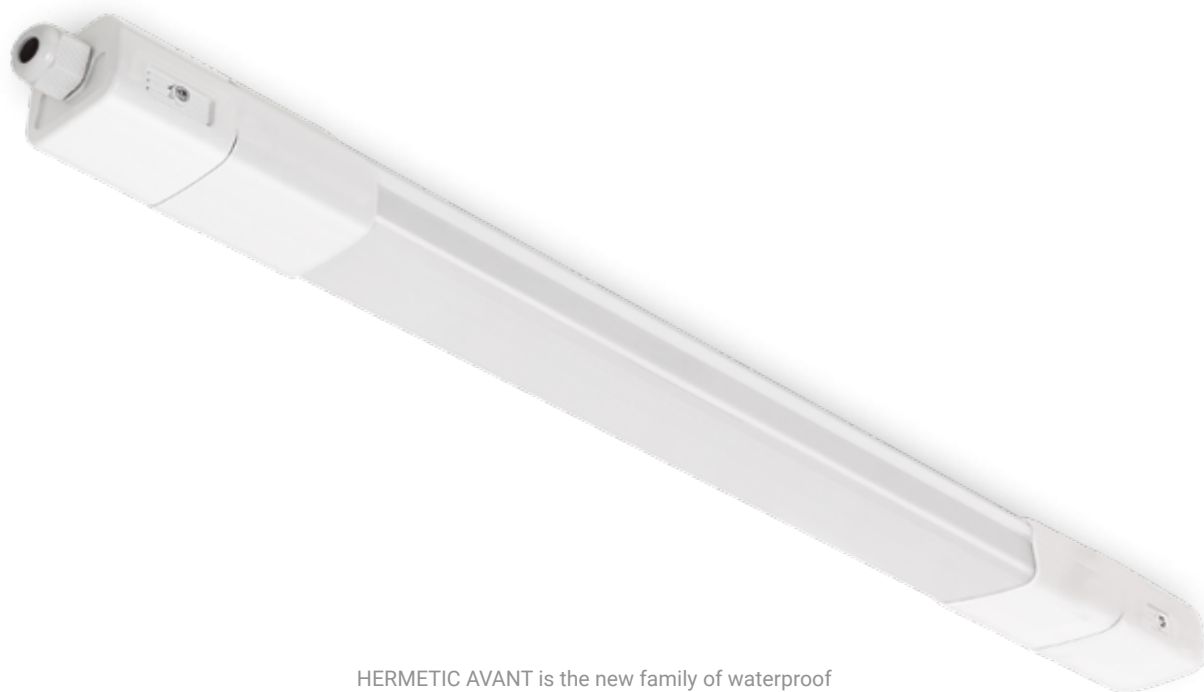

HERMETIC AVANT is the new family of waterproof fittings from Normalit, a versatile solution designed to adapt to all types of industrial spaces thanks to its wide versatility and high resistance.

## Three sizes

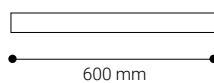
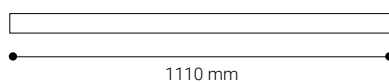
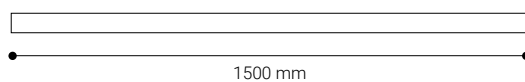

Wall surface mounted

Surface ceiling mounted



## Hermetic Avant

Installation	Surface ceiling mounted Wall surface mounted
Diffuser	☉
Light source	LED
Photobiological safety	0
UGR	22
CRI	>80
MacAdam ellipse	3
Beam angle range	135
Power range (W)	17,8-54
Colour temperature (°K)	4000
Light range	2250-7500
Power factor	0,95
Efficiency (%)	80
Expectancy	54000 h L70B10
DALI Option	–
Continuous operation 24h	✓
IP	66
IK	08
Class	II
Energy efficiency	C   D

☉ Opal diffuser



Occupancy sensor  
(-S references only)



### Version with occupancy sensor

HERMETIC AVANT product range includes a version with an occupancy sensor built-in, which is configurable with Dip-Switch technology and includes different options of range, time to switch-on and sensitivity in order to optimize the energetic efficiency of the luminaires and achieve an ideal adaptation to each location.



## Designed for industrial spaces

The HERMETIC AVANT range has been specially designed for spaces with special requirements regarding IP, impact resistance and extreme environmental conditions, such as industrial installations, car parks, warehouses or areas of high humidity or high dirt.

### 24 hour continuous operation

Enjoy optimal performance of the fittings throughout the day.





**Maximum protection**

With an IP66 degree of protection, the housing is dust-tight and protects the luminaire from potential impacts and environmental conditions such as high humidity

IP66 

The strength and versatility of the Hermetic Avant range allows an ideal adaptation to the most demanding spaces.



**An installation three times easier**

Hermetic Avant incorporates a combination of special features unique in the market to simplify, speed up and optimize the installation process, as well as the maintenance of the luminaire.

**Mobile fastening system**

An innovative mechanism with metal cramps that slide along the base of the luminaire to achieve greater speed and comfort in assembly, increasing installation possibilities.

**Quick connection without disassembly**

The hermetic covers of the HERMETIC AVANT range can be unscrewed, facilitating this way the work of the installer and offering a direct access to the terminal blocks from the bottom of the luminaire without needing to disassemble the fitting.

**Double power connection**

A double connection system for in-line assembly that allows an optimal adaptability to the space and including an aesthetic sensitivity thanks to the option of transforming the ends into blind covers.

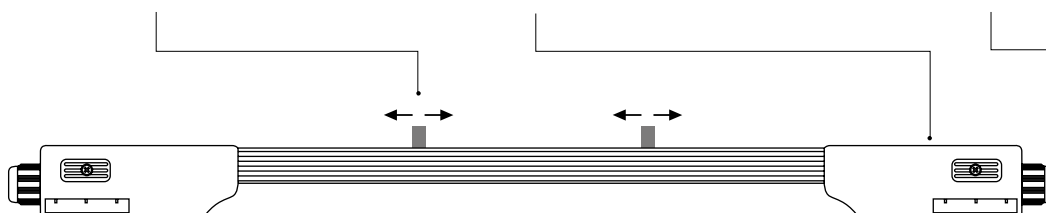

# Hermetic Avant

Surface ceiling mounted

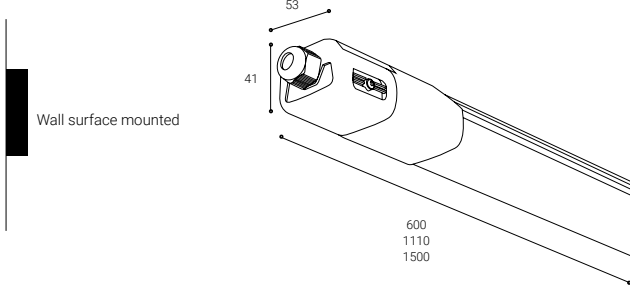

Wall surface mounted

<b>54000 h.</b> L70B10	CRI <b>&gt;80</b>	<b>135°</b>	Efficiency (%) <b>80</b>	IK <b>08</b>
---------------------------	----------------------	-------------	-----------------------------	-----------------

Photobiological safety

**RG0** Risk free

\*Time under 3h

**Go to page 443 to learn more**



## OPAL DIFFUSER

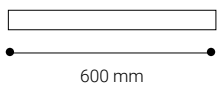

	K	REF.	W	LUMEN			REF. DALI
IP <b>66</b>	4000	<b>DV18</b>	17,8 W	2250 lm		0,3	—
		<b>DV18S</b>	17,8 W	2250 lm		0,3	—
UGR <b>22</b>							

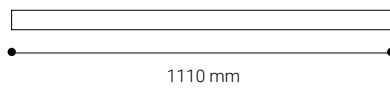
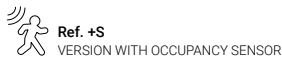

	K	REF.	W	LUMEN			REF. DALI
IP <b>66</b>	4000	<b>DV36</b>	32,4 W	4500 lm		0,5	—
		<b>DV36S</b>	32,4 W	4500 lm		0,5	—
UGR <b>22</b>							

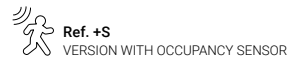

## RAL9016

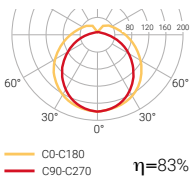

# Hermetic Avant

Surface ceiling mounted

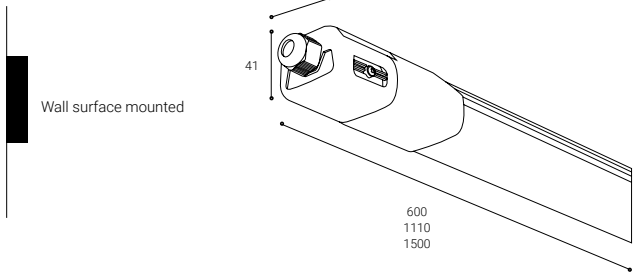

<b>54000 h.</b> L70B10	CRI <b>&gt;80</b>	<b>135°</b>	Efficiency (%) <b>80</b>	IK <b>08</b>
---------------------------	-------------------	-------------	--------------------------	--------------

Photobiological safety  
**RG0** Risk free  
\*Time under 3h.  
**Go to page 443 to learn more**

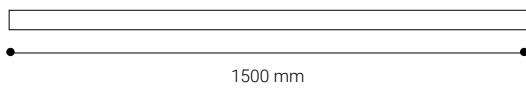

	K	REF.	W	LUMEN			REF. DALI
IP <b>66</b>	4000	<b>DV60</b>	54 W	7500 lm		0,6	—
		<b>DV60S</b>	54 W	7500 lm		0,6	—
UGR <b>22</b>							

**Ref. +S**  
VERSION WITH OCCUPANCY SENSOR

Maximum number of luminaires according to model

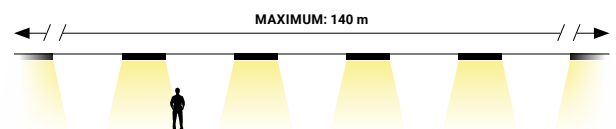

	MAXIMUM UNITS	TOTAL MAXIMUM POWER
<b>DV18 / DV18S</b>	22	396 W
<b>DV36 / DV36</b>	11	396 W
<b>DV60 / DV60S</b>	7	420 W

**140 meters** of maximum line connection length, for a cable with a 1.5 mm section.

# Hermetic Line



HERMETIC LINE is a watertight IP66 luminaire.  
It is ideal for basements, garages or any  
industrial activity.

The extruded polycarbonate body can be  
adjusted to any length.

## Four sizes

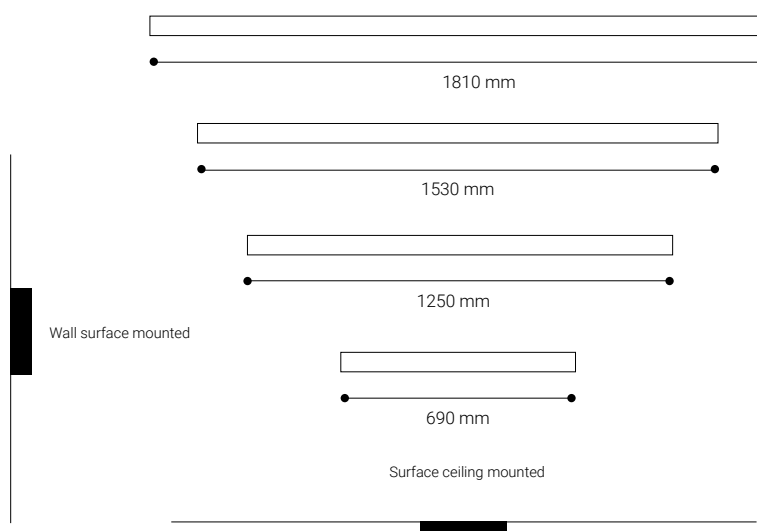



## Hermetic Line

Installation	Surface ceiling mounted Wall surface mounted
Diffuser	☉
Light source	LED
Photobiological safety	0
UGR	22
CRI	>80
MacAdam ellipse	3
Beam angle range	110
Power range (W)	13,4-57
Colour temperature (°K)	4000
Light range	1680-7740
Power factor	0,95
Efficiency (%)	78,44
Expectancy	72000 h L70B10
DALI Option	✓
Continuous operation 24h	✓
IP	66
IK	09
Class	I
Energy efficiency	C   D

☉ Opal diffuser

### Two types of connection

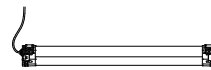

CONNECTION IN ONE SIDE

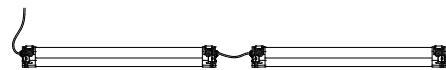

CONNECTION ON BOTH SIDES

### Cable entry in both ends, possibility of linear mounting

(except ref. DLN that only has one cable entry).

IP66  in interiors

 For other CRI values, please contact us.

# Hermetic Line

Surface ceiling mounted

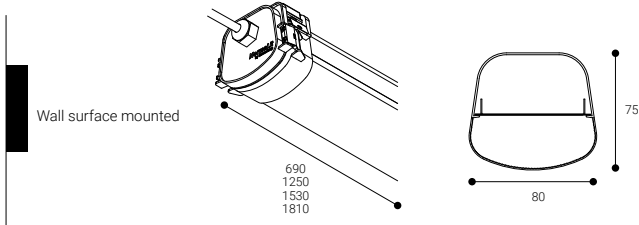

<b>72000 h.</b> L70B10	CRI <b>&gt;80</b>	<b>110°</b>	Efficiency (%) <b>78,44</b>	IK <b>09</b>
---------------------------	----------------------	-------------	--------------------------------	-----------------

Photobiological safety

**RG0** Risk free

\*Time under 3 h

**Go to page 443 to learn more**

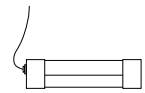

## CONNECTION ON ONE SIDE



	K	REF.	W	LUMEN			REF. DALI
IP <b>66</b>	4000	<b>DLN2L</b>	13,4 W	1680 lm		1,3	—
		<b>DLN2H</b>	19 W	2580 lm		1,3	—
UGR <b>22</b>							

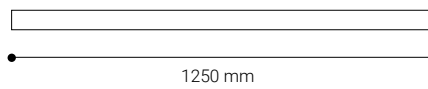

	K	REF.	W	LUMEN			REF. DALI
IP <b>66</b>	4000	<b>DLN4L</b>	26,8 W	3360 lm		2,5	—
		<b>DLN4H</b>	38 W	5160 lm		2,5	—
UGR <b>22</b>							

**RAL7001**

Opal diffuser

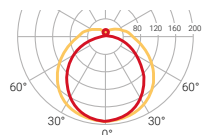

C0-C180  
 C90-C270 **η=78%**

# Hermetic Line

Surface ceiling mounted

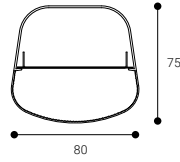
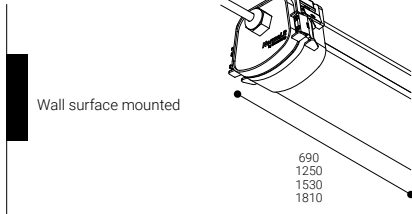

72000 h.  
L70B10

CRI  
>80

△  
110°

Efficiency (%)  
78,44

IK  
09

Photobiological safety

RG0 **0** Risk free

\*Time under 3 h.

Go to page 443 to learn more

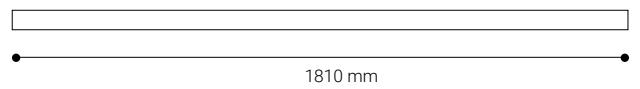
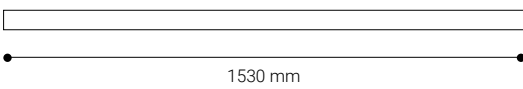

	K	REF.	W	LUMEN			REF. DALI
IP <b>66</b>	4000	<b>DLN5L</b>	33,5 W	4200 lm			—
		<b>DLN5H</b>	47,5 W	6450 lm			—
UGR <b>22</b>							

	K	REF.	W	LUMEN			REF. DALI
IP <b>66</b>	4000	<b>DLN6L</b>	40,2 W	5040 lm			—
		<b>DLN6H</b>	57 W	7740 lm			—
UGR <b>22</b>							

# Hermetic Line

Surface ceiling mounted

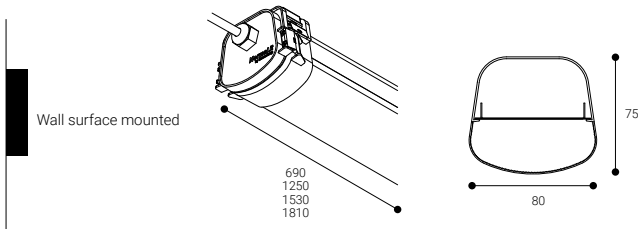
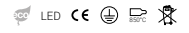

<b>72000 h.</b> L70B10	CRI <b>&gt;80</b>	<b>110°</b>	Efficiency (%) <b>78,44</b>	IK <b>09</b>
---------------------------	----------------------	-------------	--------------------------------	-----------------

Photobiological safety

**RG0** Risk free

\*Time under 3 h

**Go to page 443 to learn more**

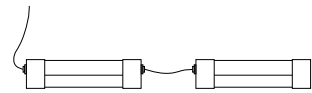

## CONNECTION ON BOTH SIDES (LINEAR INSTALLATION)

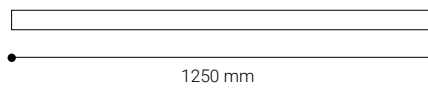
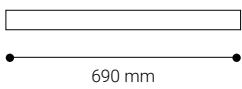

	K	REF.	W	LUMEN			REF. DALI
IP <b>66</b>		<b>DL2L</b>	13,4 W	1680 lm		1,3	<b>DL2LD</b>
		<b>DL2H</b>	19 W	2580 lm		1,3	<b>DL2HD</b>
UGR <b>22</b>							

	K	REF.	W	LUMEN			REF. DALI
IP <b>66</b>		<b>DL4L</b>	26,8 W	3360 lm		2,5	<b>DL4LD</b>
		<b>DL4H</b>	37 W	5160 lm		2,5	<b>DL4HD</b>
UGR <b>22</b>							

**RAL7001**

Opal diffuser

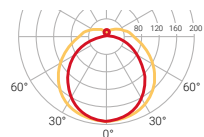

C0-C180  
 C90-C270     **η=78%**

Compatible with **NormaLINK**



# Hermetic Line

Surface ceiling mounted

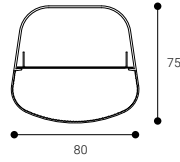
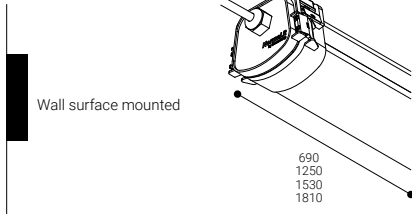

72000 h.  
L70B10

CRI  
>80

△  
110°

Efficiency (%)  
78,44

IK  
09

Photobiological safety

RG0 **0** Risk free

\*Time under 3 h.

Go to page 443 to learn more

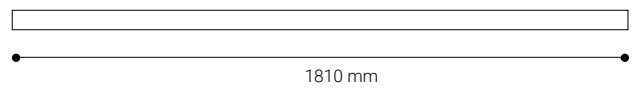
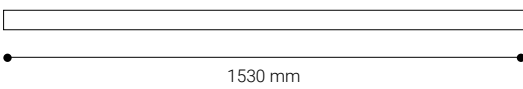

	K	REF.	W	LUMEN			REF. DALI
IP <b>66</b>	4000	<b>DL5L</b>	33,5 W	4200 lm		3,1	<b>DL5LD</b>
		<b>DL5H</b>	47,5 W	6450 lm		3,1	<b>DL5HD</b>
UGR <b>22</b>							

	K	REF.	W	LUMEN			REF. DALI
IP <b>66</b>	4000	<b>DL6L</b>	40,2 W	5040 lm		3,7	—
		<b>DL6H</b>	57 W	7740 lm		3,7	—
UGR <b>22</b>							

# Hermetic XL



HERMETIC XL is a watertight (IP66) luminaire which is ideal for basements, garages or any industrial activity. Specifically designed with LED technology, it incorporates the new and revolutionary quick installation system which improves installation time and optimises maintenance work.

## Two sizes

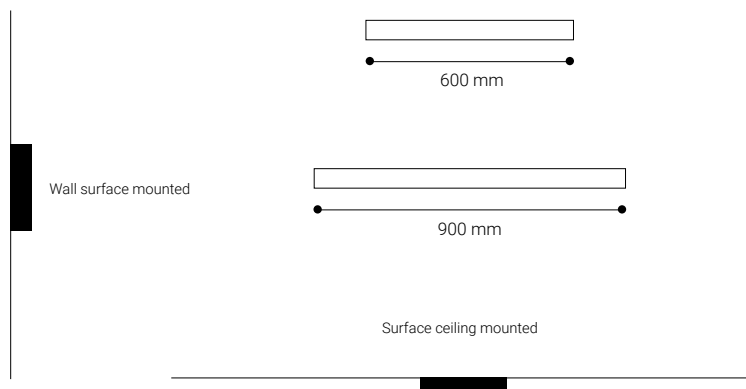

Low temperatures unit version. On request.



## Hermetic XL

Installation	Surface ceiling mounted Wall surface mounted
Diffuser	☉
Light source	LED
Photobiological safety	0
UGR	22
CRI	>80
MacAdam ellipse	3
Beam angle range	110
Power range (W)	13,4-28,5
Colour temperature (°K)	4000
Light range	1680-3870
Power factor	0,95
Efficiency (%)	80,1
Expectancy	72000 h L70B10
DALI Option	–
Continuous operation 24h	✓
IP	66
IK	09
Class	II
Energy efficiency	D

☉ Opal diffuser

### Quick installation



CRI 360 | For other CRI values, please contact us.

# Hermetic XL

Surface ceiling mounted

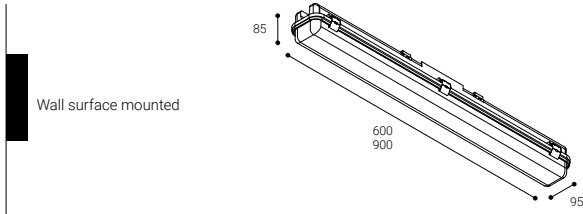

<b>72000 h.</b> L70B10	CRI <b>&gt;80</b>	<b>110°</b>	Efficiency (%) <b>80,1</b>	IK <b>09</b>
---------------------------	----------------------	-------------	-------------------------------	-----------------

Photobiological safety

**RG0** Risk free

\*Time under 3h

**Go to page 443 to learn more**



## OPAL DIFFUSER

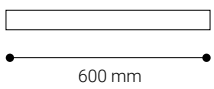

	K	REF.	W	LUMEN			REF. DALI
IP <b>66</b>	4000	<b>DE2L</b>	13,4 W	1680 lm		1,2	—
		<b>DE2H</b>	19 W	2580 lm		1,2	—
UGR <b>22</b>							

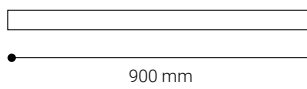

	K	REF.	W	LUMEN			REF. DALI
IP <b>66</b>	4000	<b>DE3L</b>	20,1 W	2520 lm		1,8	—
		<b>DE3H</b>	28,5 W	3870 lm		1,8	—
UGR <b>22</b>							

## RAL7001

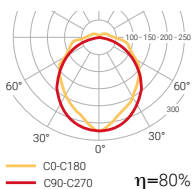

**DALI REGULATION AVAILABLE**

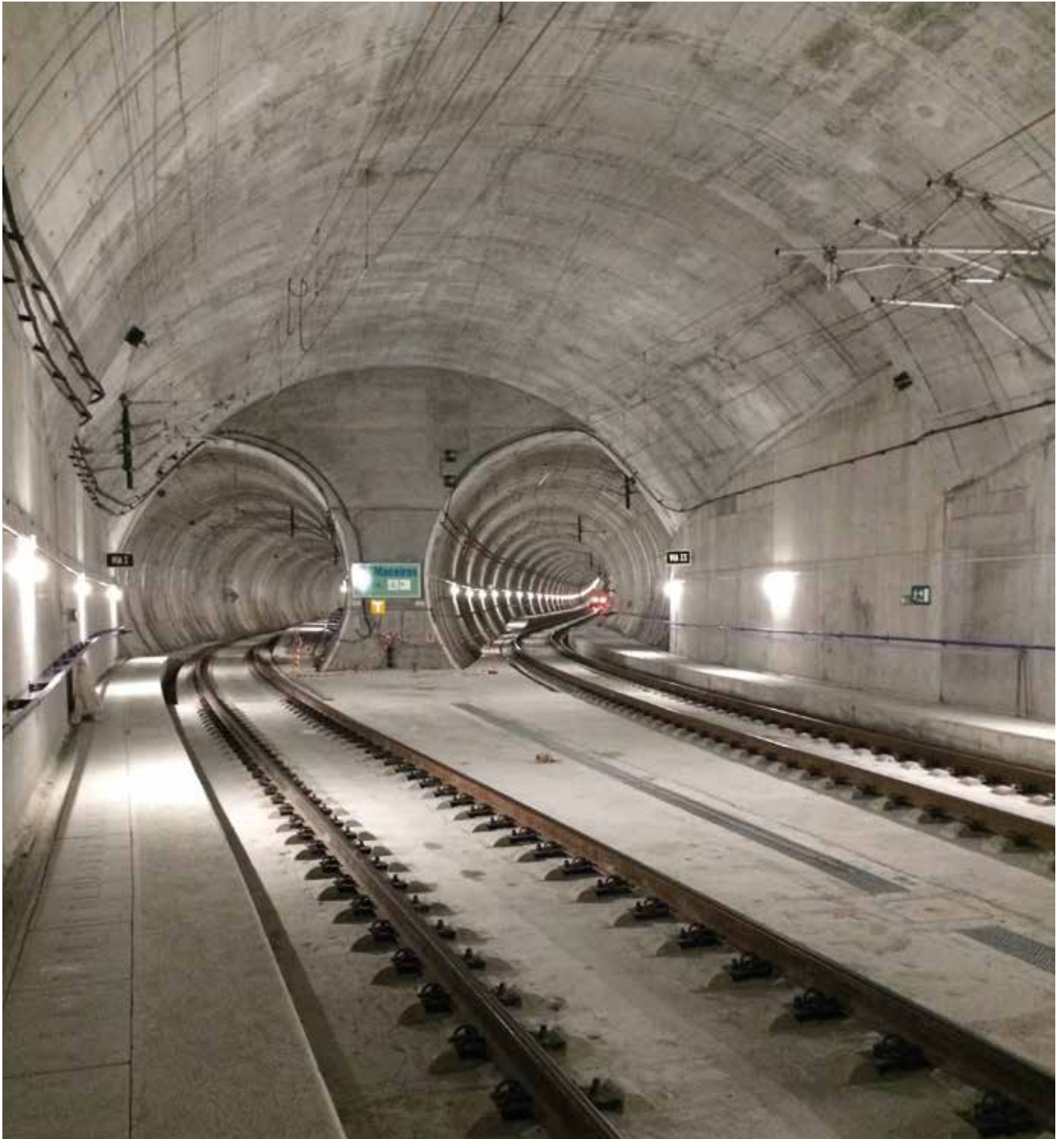

# Linear luminaires





U-Line  
264



Linnea  
270



Linnea Mixto  
276



Eyre  
278



Trazzo Avant  
286

Available in SALUZ



Trazzo 70  
305



Trazzo Mixto  
319



Cosmos  
326



Sycom  
332



Coral  
338

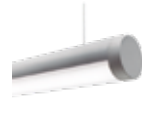

Zafiro  
342



LED strips  
347

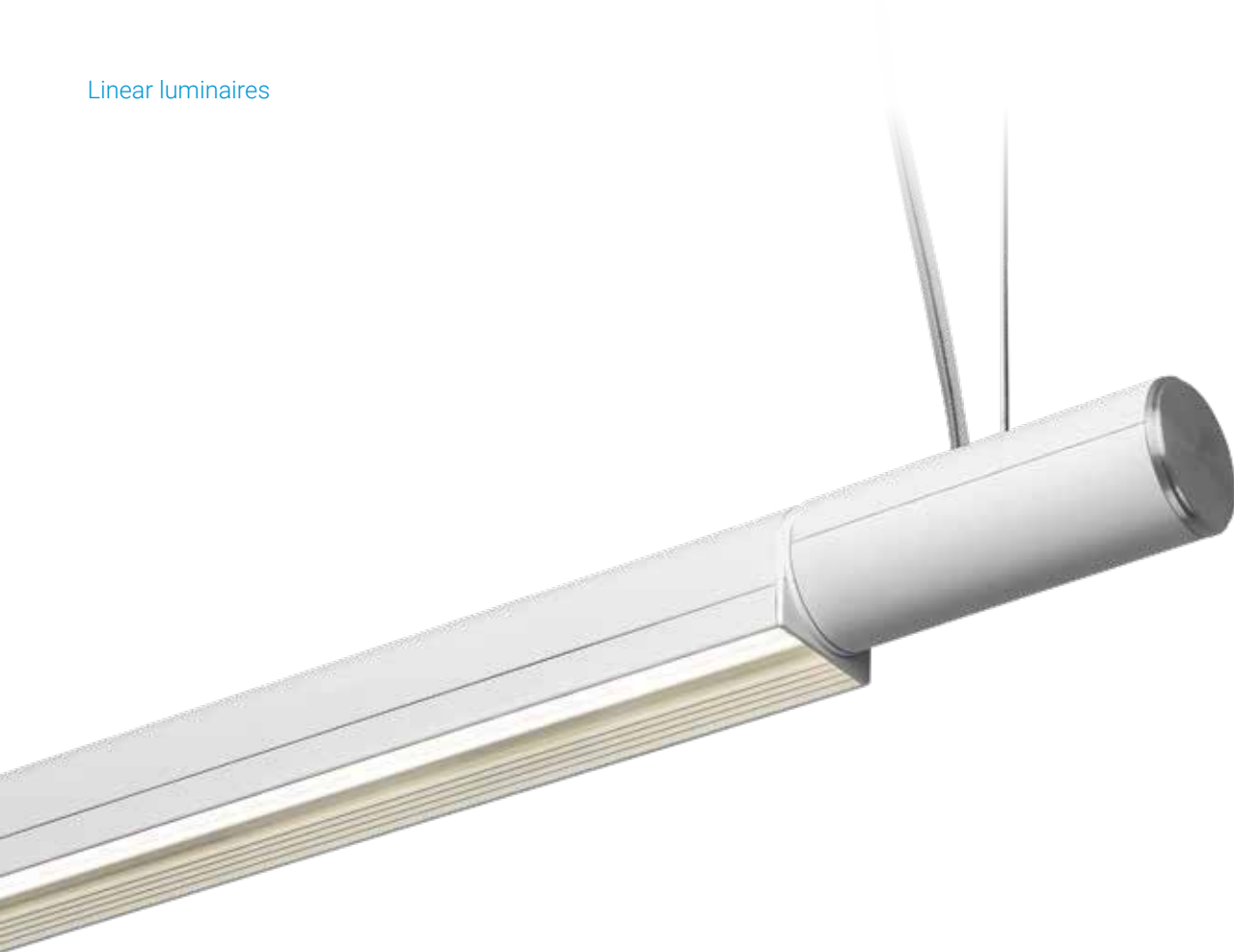

# U-Line

U-LINE is a minimalist linear system for suspended installation which can be integrated into any space surprisingly easily.

The luminaire consists of the power supply connection (available in different power and colors) and the light source itself (available in different powers and temperature colors).

Two sizes

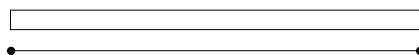

1200 mm

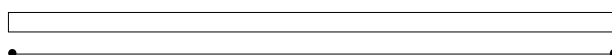

1760 mm

Suspended ceiling mounted







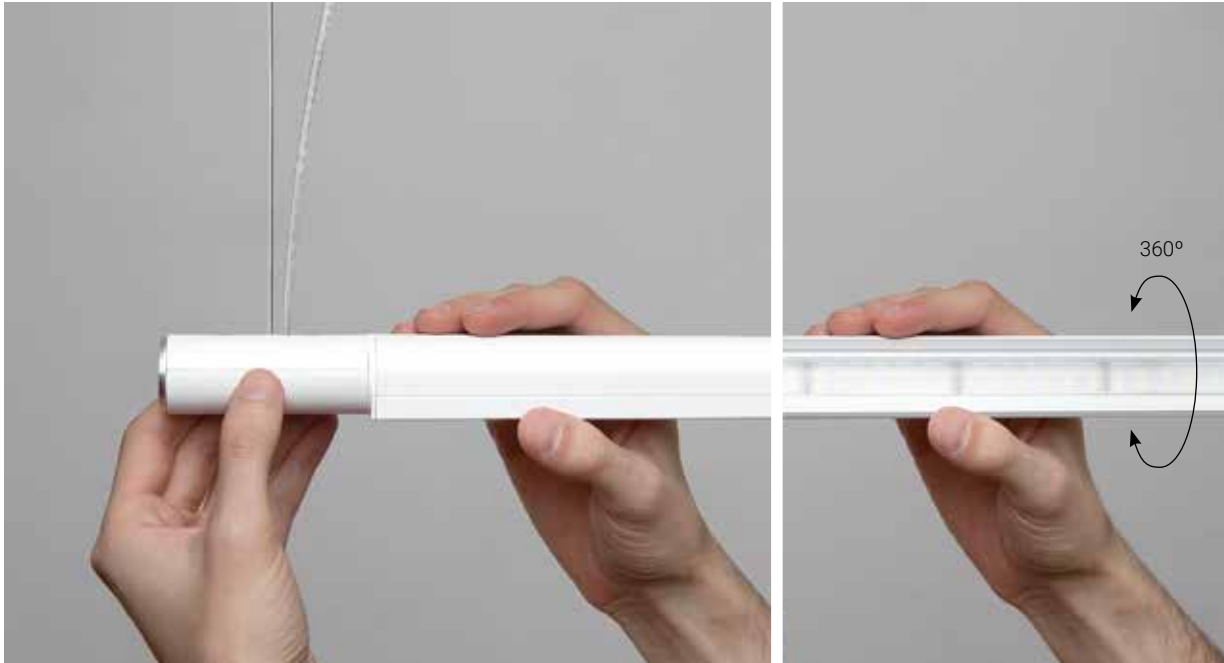

### Rotation 360°

It has a 360° light rotation system that makes it an extremely versatile luminaire.

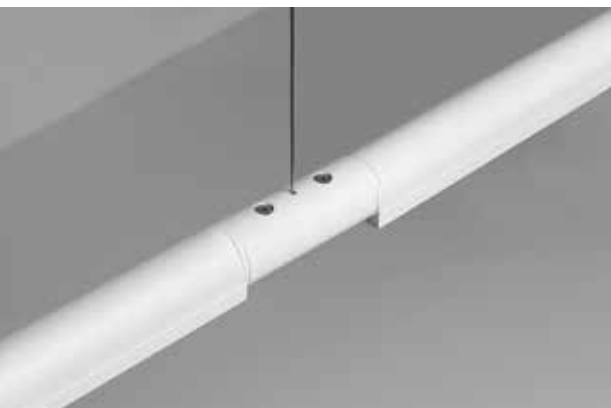

U-LINE can be installed in continuous lines by means of an installation accessory.



## U-Line

Installation	Suspended ceiling mounted
Diffuser	☉
Light source	LED
Photobiological safety	0
UGR	19
CRI	>80
MacAdam ellipse	3
Beam angle range	55
Power range (W)	23-34,6
Colour temperature (°K)	3000   4000
Light range	2480-3960
Power factor	0,95
Efficiency (%)	72
Expectancy	72000 h L70B10
DALI Option	–
Continuous operation 24h	✓
IP	30
Class	II
Energy efficiency	E



For other CRI values,  
please contact us.

☉ Anti glare prismatic polycarbonate diffuser



RAL9016



RAL9005

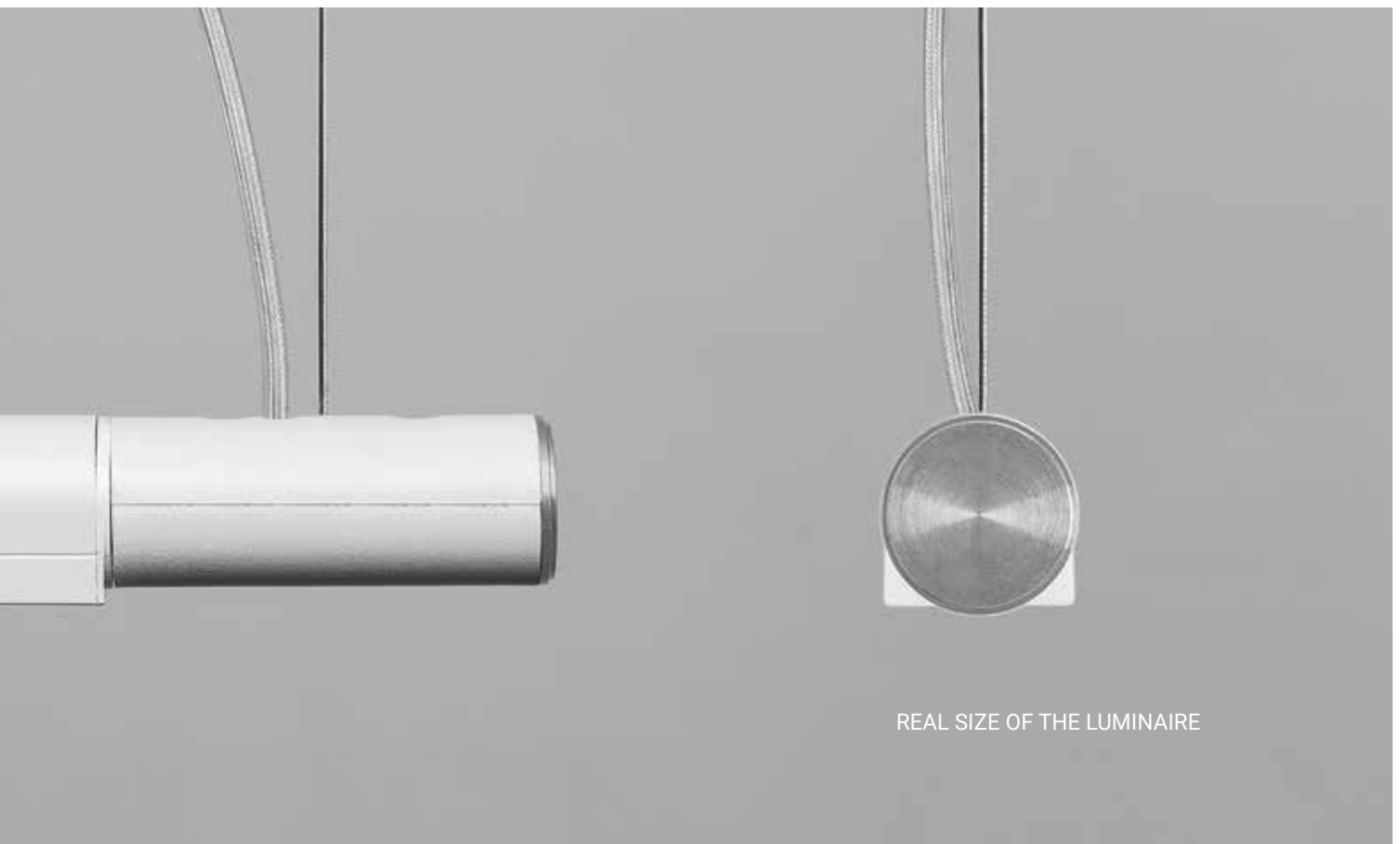

REAL SIZE OF THE LUMINAIRE

# U-Line

Suspended ceiling mounted

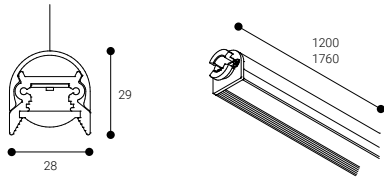

72000 h. L70B10 | CRI >80 | 55° | Efficiency (%) 72

Photobiological safety

RG0 0 Risk free

\*Time under 3 h

Go to page 443 to learn more

360 For other lengths and powers, please contact us



## OPAL DIFFUSER

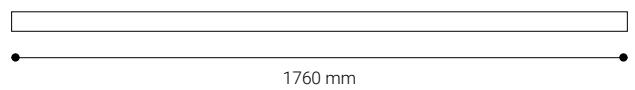
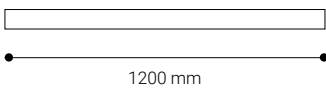

	K	REF.	W	LUMEN			REF. DALI
IP 30	3000	<b>UL43B</b>	23 W	2480 lm	○	1,4	—
UGR 19	4000	<b>UL44B</b>	23 W	2640 lm	○	1,4	—

	K	REF.	W	LUMEN			REF. DALI
IP 30	3000	<b>UL63B</b>	34,6 W	3720 lm	○	2,0	—
UGR 19	4000	<b>UL64B</b>	34,6 W	3960 lm	○	2,0	—

- RAL9016
- RAL9005 Replace "B" by "N" in the reference

ULA POWER SUPPLY ACCESSORY NOT INCLUDED

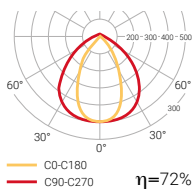

# U-Line

ACCESSORIES

Power supply

	W	L	COLOUR
<b>ULA06B</b>	35	70	○
<b>ULA06N</b>	35	70	●
<b>ULA10B</b>	60	70	○
<b>ULA10N</b>	60	70	●
<b>ULA16B</b>	96	70	○
<b>ULA16N</b>	96	70	●

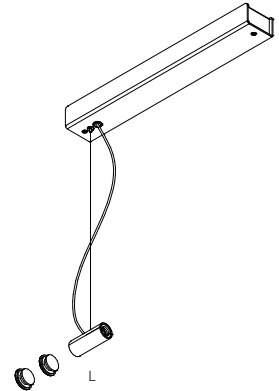

Power supply

Compatible with **NormaLINK**



	W	L	COLOUR
<b>ULA06DB</b>	35	70	○
<b>ULA06DN</b>	35	70	●
<b>ULA10DB</b>	60	70	○
<b>ULA10DN</b>	60	70	●
<b>ULA16DB</b>	100	70	○
<b>ULA16DN</b>	100	70	●

The number of power connections depends on the W in the installation.

Basic installation example: **ULA06N+UL43N**

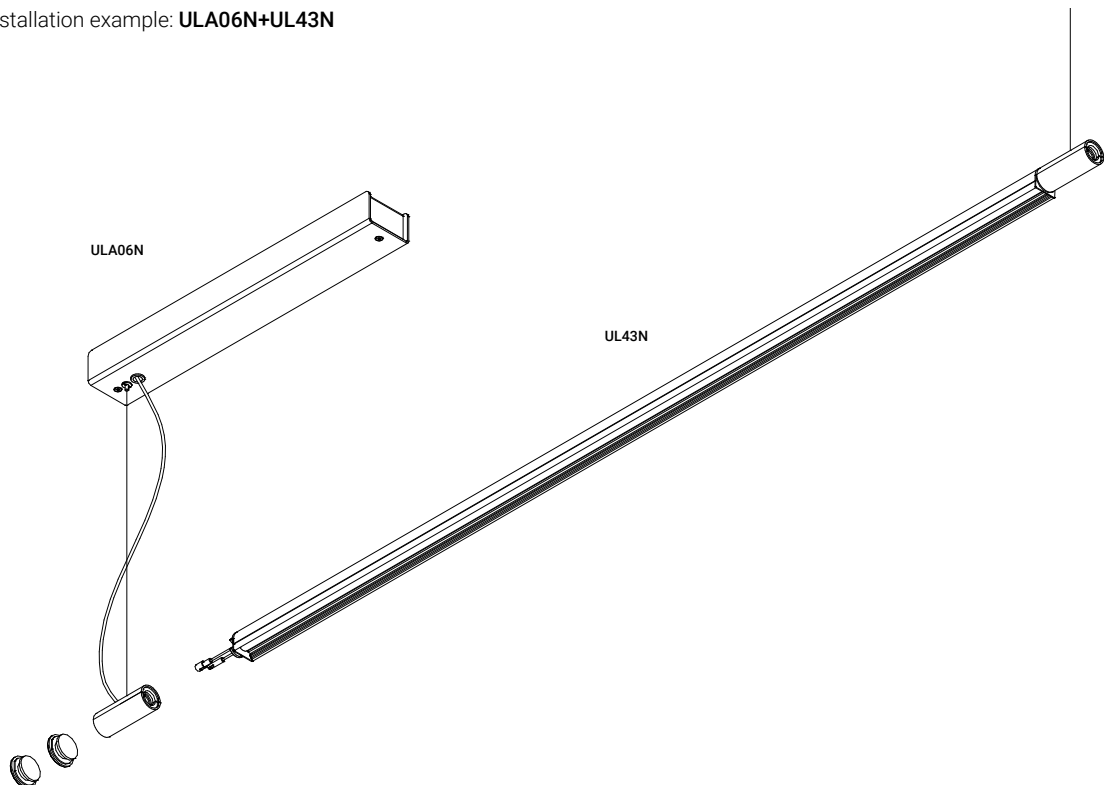



# Linnea

LINNEA is a linear luminaire built with an extruded aluminium profile for suspended installation, ceiling mounted installation or recessed installation.

It stands out thanks to its minimal design and its microprismatic diffuser which generates very homogeneous lighting with optimal visual comfort.

## Two versions

Linnea



direct lighting

Linnea Mixto



direct/indirect lighting

Ceiling recessed mounted

Suspended ceiling mounted

Surface ceiling mounted





as03



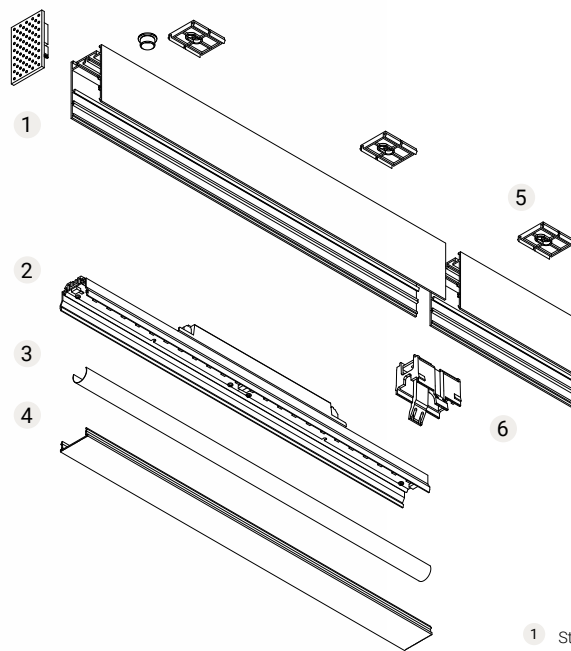

- 1 Structure
- 2 LED holder heat sink
- 3 Opal intermediate diffuser
- 4 Microprismatic diffuser
- 5 Fixation accessories
- 6 Joint accessories

## Linnea

## Linnea Mixto

Installation

Surface ceiling mounted  
Suspended ceiling mounted  
Ceiling recessed mounted

Suspended ceiling mounted

Diffuser



Light source

LED

LED

Photobiological safety

0

0

UGR

19

19

CRI

>80

>80

MacAdam ellipse

3

3

Beam angle range

87

87

Power range (W)

26,8-57

46,9-104,5

Colour temperature (°K)

3000 | 4000

3000 | 4000

Light range

3720-9000

6510-16500

Power factor

0,95

0,95

Efficiency (%)

61,1

64,6

Expectancy

60000 h L70B10

60000 h L70B10

DALI Option



Continuous operation 24h



IP

30 | 20-44

30

Class

I

I

Energy efficiency

B | C

D

⊙ Microprismatic diffuser



For other CRI values,  
please contact us.



RAL9016

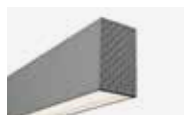

RAL7001





- 1 Quick installation support for suspension or surface mounting
- 2 Integrated heat sink, increases the useful life



Please request technical specifications of all the luminaires or visit our website.

# Linnea

Suspended ceiling mounted

Surface ceiling mounted

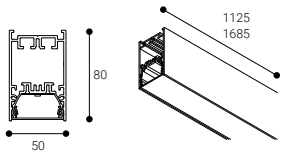

60000 h. L70B10 | CRI >80 | 87° | Efficiency (%) 61,1

Photobiological safety

RG0 0 Risk free

\*Time under 3h

Go to page 443 to learn more



## ☉ MICROPRISMATIC DIFFUSER / DIRECT LIGHTING

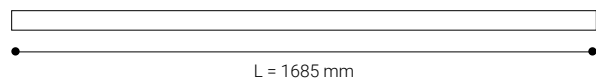
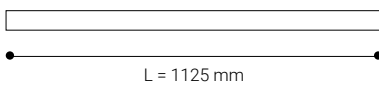

	K	REF.	W	LUMEN			REF. DALI
IP 30	3000	LI4L30B	26,8 W	3720 lm	○	2,8	LI4L3DOB
		LI4H30B	38 W	5600 lm	○	2,8	LI4H3DOB
UGR 19	4000	LI4L40B	26,8 W	4000 lm	○	2,8	LI4L4DOB
		LI4H40B	38 W	6000 lm	○	2,8	LI4H4DOB

	K	REF.	W	LUMEN			REF. DALI
IP 30	3000	LI6L30B	40,2 W	5580 lm	○	4,1	LI6L3DOB
		LI6H30B	57 W	8400 lm	○	4,1	LI6H3DOB
UGR 19	4000	LI6L40B	40,2 W	6000 lm	○	4,1	LI6L4DOB
		LI6H40B	57 W	9000 lm	○	4,1	LI6H4DOB

- RAL9016
- RAL7001 Replace "B" by "G" in the reference

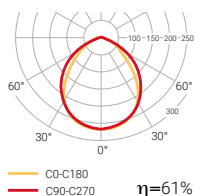

# Linnea

Ceiling recessed mounted

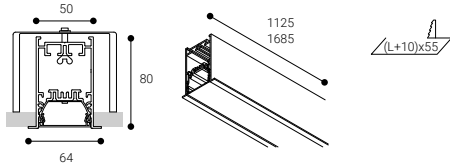

60000 h. L70B10 | CRI >80 | 87° | Efficiency (%) 61,1

Photobiological safety

RG0 0 Risk free

\*Time under 3 h.

Go to page 443 to learn more



## © MICROPRISMATIC DIFFUSER / DIRECT LIGHTING

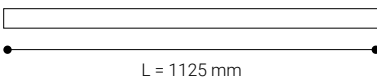

L = 1125 mm

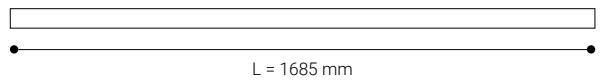

L = 1685 mm

	K	REF.	W	LUMEN			REF. DALI
IP 20-44	3000	LE4L3OB	26,8 W	3720 lm	○	2,9	LE4L3DOB
		LE4H3OB	38 W	5600 lm	○	2,9	LE4H3DOB
UGR 19	4000	LE4L4OB	26,8 W	4000 lm	○	2,9	LE4L4DOB
		LE4H4OB	38 W	6000 lm	○	2,9	LE4H4DOB

	K	REF.	W	LUMEN			REF. DALI
IP 20-44	3000	LE6L3OB	40,2 W	5580 lm	○	4,3	LE6L3DOB
		LE6H3OB	57 W	8400 lm	○	4,3	LE6H3DOB
UGR 19	4000	LE6L4OB	40,2 W	6000 lm	○	4,3	LE6L4DOB
		LE6H4OB	57 W	9000 lm	○	4,3	LE6H4DOB

- RAL9016
- RAL7001 Replace "B" by "G" in the reference

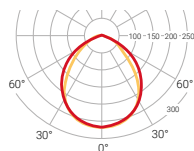

C0-C180  
C90-C270  $\eta=61\%$

Compatible with NormaLINK

# Linnea Mixto

Suspended ceiling mounted

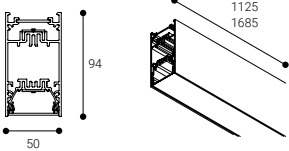

60000 h. L70B10 | CRI >80 | 87° | Efficiency (%) 64,6

Photobiological safety

RG0 0 Risk free

\*Time under 3 h.

Go to page 443 to learn more

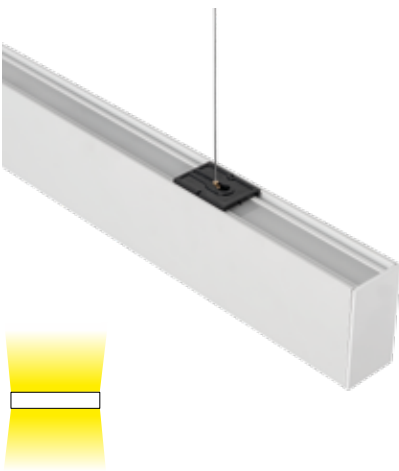

## © MICROPRISMATIC DIFFUSER / DIRECT/INDIRECT LIGHTING

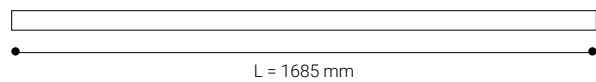
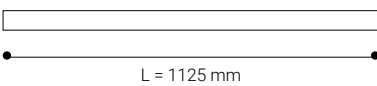

	K	REF.	W	LUMEN			REF. DALI
IP 30	3000	LM4L3OB	46,9 W	6510 lm	○	3,3	LM4L3DOB
		LM4H3OB	66,5 W	9800 lm	○	3,3	LM4H3DOB
UGR 19	4000	LM4L4OB	46,9 W	7000 lm	○	3,3	LM4L4DOB
		LM4H4OB	66,5 W	10500 lm	○	3,3	LM4H4DOB

	K	REF.	W	LUMEN			REF. DALI
IP 30	3000	LM6L3OB	73,7 W	10230 lm	○	4,9	LM6L3DOB
		LM6H3OB	104,5 W	15400 lm	○	4,9	LM6H3DOB
UGR 19	4000	LM6L4OB	73,7 W	11000 lm	○	4,9	LM6L4DOB
		LM6H4OB	104,5 W	16500 lm	○	4,9	LM6H4DOB

- RAL9016
- RAL7001 Replace "B" by "G" in the reference

Direct lighting

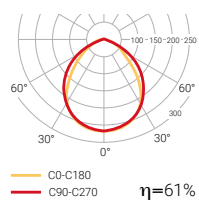

Indirect lighting

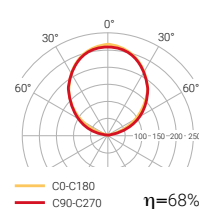

# Linnea and Linnea Mixto

ACCESSORIES

Suspension accessory

	L (m)
<b>1029L2</b>	2
<b>1029L4</b>	4

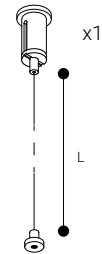

Connection box and power supply cable

	POWER SUPPLY CABLE LENGTH	COLOUR
<b>ETC1029B</b>	2	○
<b>ETC1029G</b>	2	●
<b>ETC10294MB</b>	4	○
<b>ETC10294MG</b>	4	●
 <b>ETC10295PB</b>	2	○
<b>ETC10295PG</b>	2	●
<b>ETC10295P4MB</b>	4	○
<b>ETC10295P4MG</b>	4	●

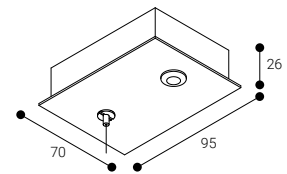

Joining accessory

	COLOUR
<b>LI014</b>	○
 <b>LI0145P</b>	○

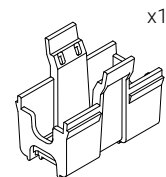

End cover Linnea

	COLOUR
<b>LI015B</b>	○
<b>LI015G</b>	●
<b>LI016B</b>	○
<b>LI016G</b>	●

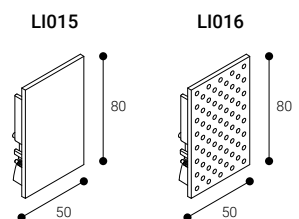

End cover Linnea Mixto

	COLOUR
<b>LM015B</b>	○
<b>LM015G</b>	●
<b>LM016B</b>	○
<b>LM016G</b>	●

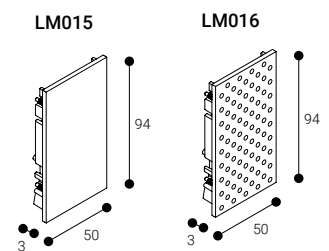

End cover recessed model

	COLOUR
<b>LE016B</b>	○
<b>LE016G</b>	●

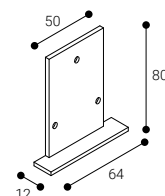

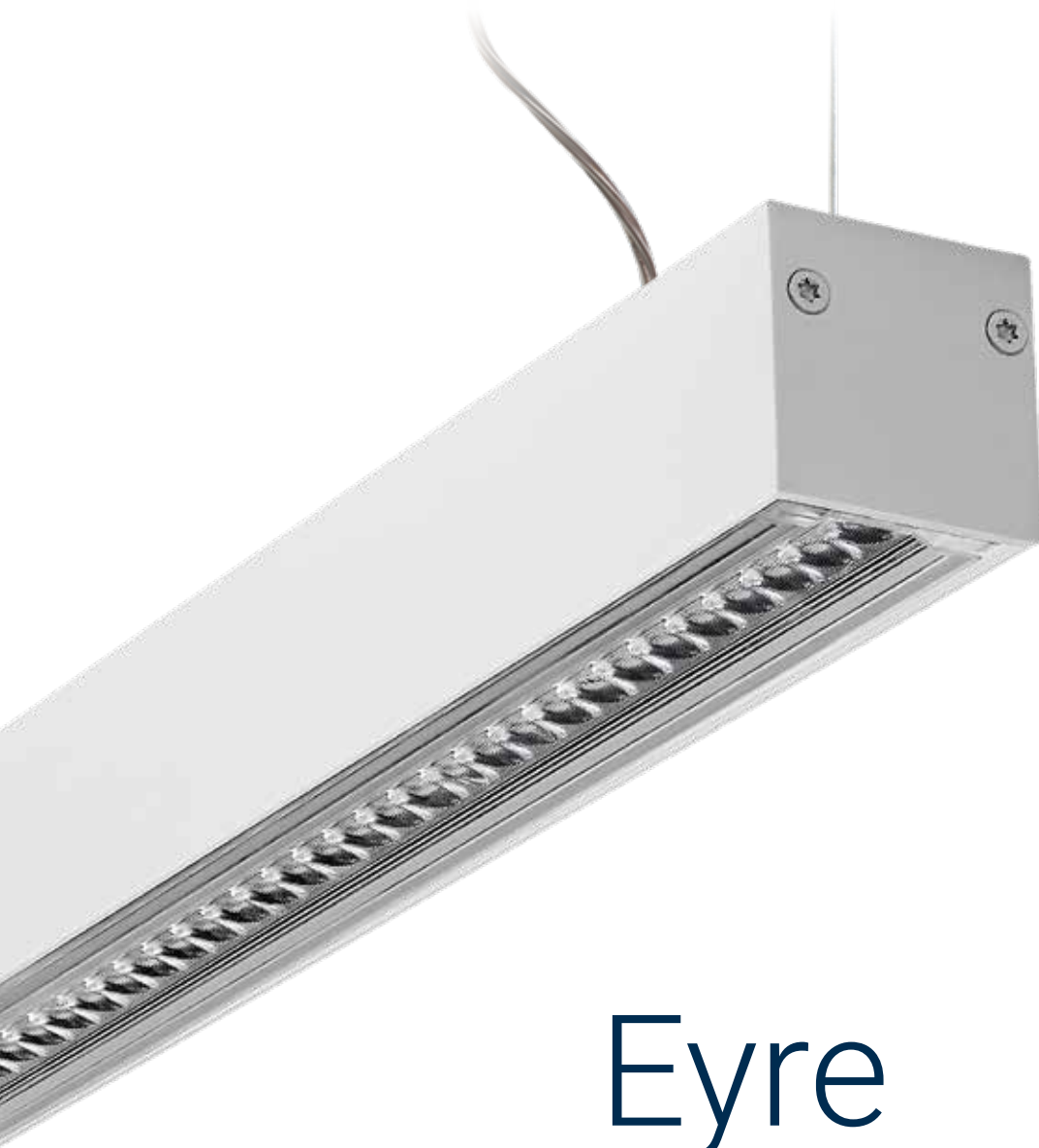

# Eyre

Innovative linear system for linked or suspended installation. Manufactured in extruded aluminium, and available in 1,127 y 1,686mm sections.

It features a lens system for lighting that enhances visual comfort.

## Four optics

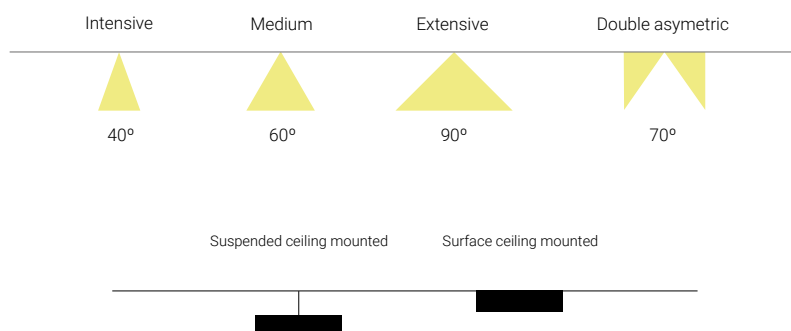



Easy-to-adjust  
suspended  
mounting



Please request technical specifications of all the luminaires or visit our website.



For other CRI values, please contact us.

## Eye

Installation  
Suspended ceiling mounted  
Surface ceiling mounted

Diffuser	⊗
Light source	LED
Photobiological safety	0
UGR	19
CRI	>80
MacAdam ellipse	3
Beam angle range	40-90
Power range (W)	26,8-57
Colour temperature (°K)	3000   4000
Light range	3720-9000
Power factor	0,95
Efficiency (%)	93
Expectancy	60000 h L70B10
DALI Option	✓
Continuous operation 24h	✓
IP	30
Class	I
Energy efficiency	B   C
⊗ PMMA lens	



RAL9016



RAL9005

PMMA lens



# Eyre

Suspended ceiling mounted

Surface ceiling mounted

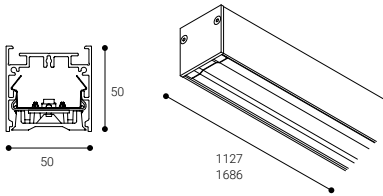

60000 h. L70B10 | CRI >80 | 40-90° | Efficiency (%) 96

Photobiological safety

RG0 0 Risk free

\*Time under 3 h.

Go to page 443 to learn more



## INTENSIVE OPTICS



40°

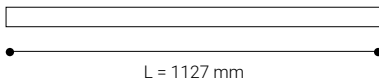

L = 1127 mm

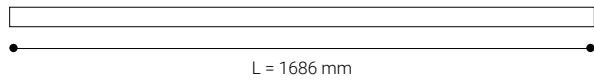

L = 1686 mm

	K	REF.	W	LUMEN			REF. DALI
IP 30	3000	LY4L3SB	26,8 W	3720 lm		2,8	LY4L3DSB
		LY4H3SB	38 W	5600 lm		2,8	LY4H3DSB
UGR 19	4000	LY4L4SB	26,8 W	4000 lm		2,8	LY4L4DSB
		LY4H4SB	38 W	6000 lm		2,8	LY4H4DSB

	K	REF.	W	LUMEN			REF. DALI
IP 30	3000	LY6L3SB	40,2 W	5580 lm		4,1	LY6L3DSB
		LY6H3SB	57 W	8400 lm		4,1	LY6H3DSB
UGR 19	4000	LY6L4SB	40,2 W	6000 lm		4,1	LY6L4DSB
		LY6H4SB	57 W	9000 lm		4,1	LY6H4DSB

- RAL9016
- RAL9005 Replace "B" by "N" in the reference

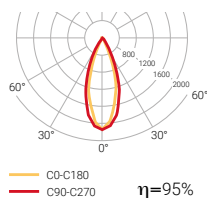



# Eyre

Suspended ceiling mounted

Surface ceiling mounted

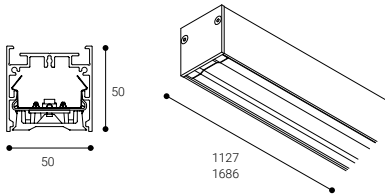

60000 h. L70B10 | CRI >80 |  $\Delta$  40-90° | Efficiency (%) 96

Photobiological safety

RG0 **0** Risk free

\*Time under 3 h.

Go to page 443 to learn more

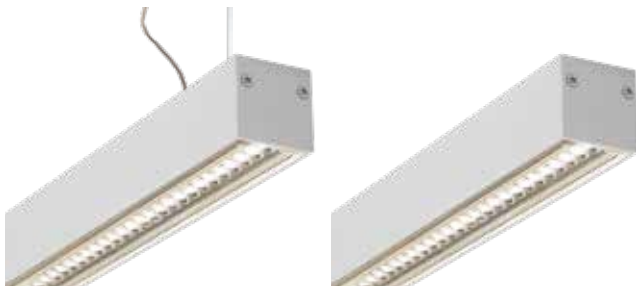

## MEDIUM OPTICS

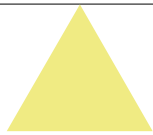

60°

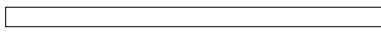

L = 1127 mm

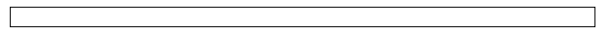

L = 1686 mm

	K	REF.	W	LUMEN			REF. DALI
IP 30	3000	LY4L3MB	26,8 W	3720 lm		2,8	LY4L3DMB
		LY4H3MB	38 W	5600 lm		2,8	LY4H3DMB
UGR 19	4000	LY4L4MB	26,8 W	4000 lm		2,8	LY4L4DMB
		LY4H4MB	38 W	6000 lm		2,8	LY4H4DMB

	K	REF.	W	LUMEN			REF. DALI
IP 30	3000	LY6L3MB	40,2 W	5580 lm		4,1	LY6L3DMB
		LY6H3MB	57 W	8400 lm		4,1	LY6H3DMB
UGR 19	4000	LY6L4MB	40,2 W	6000 lm		4,1	LY6L4DMB
		LY6H4MB	57 W	9000 lm		4,1	LY6H4DMB

RAL9016

RAL9005 Replace "B" by "N" in the reference

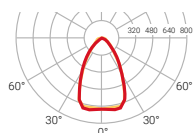

C0-C180  $\eta=92\%$   
 C90-C270



# Eyre

Suspended ceiling mounted

Surface ceiling mounted

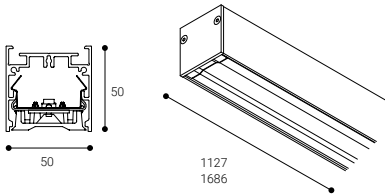

60000 h. L70B10 | CRI >80 | 40-90° | Efficiency (%) 96

Photobiological safety

RG0 0 Risk free

\*Time under 3 h.

Go to page 443 to learn more

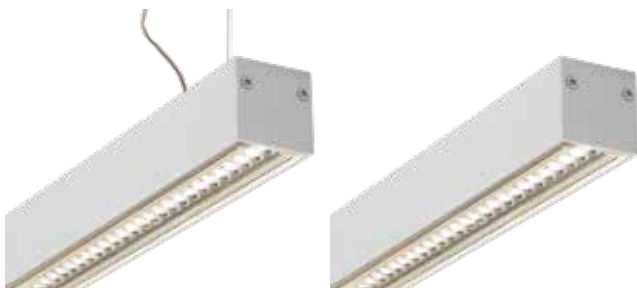

## EXTENSIVE OPTICS

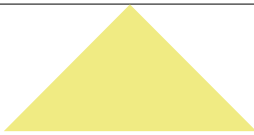

90°

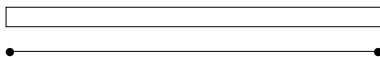

L = 1127 mm

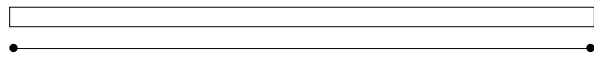

L = 1686 mm

	K	REF.	W	LUMEN			REF. DALI
IP 30	3000	LY4L3FB	26,8 W	3720 lm		2,8	LY4L3DFB
		LY4H3FB	38 W	5600 lm		2,8	LY4H3DFB
UGR 19	4000	LY4L4FB	26,8 W	4000 lm		2,8	LY4L4DFB
		LY4H4FB	38 W	6000 lm		2,8	LY4H4DFB

	K	REF.	W	LUMEN			REF. DALI
IP 30	3000	LY6L3FB	40,2 W	5580 lm		4,1	LY6L3DFB
		LY6H3FB	57 W	8400 lm		4,1	LY6H3DFB
UGR 19	4000	LY6L4FB	40,2 W	6000 lm		4,1	LY6L4DFB
		LY6H4FB	57 W	9000 lm		4,1	LY6H4DFB

- RAL9016
- RAL9005 Replace "B" by "N" in the reference

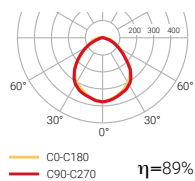

# Eyre

Suspended ceiling mounted

Surface ceiling mounted

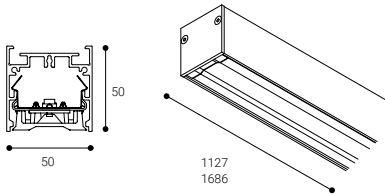

60000 h. L70B10 | CRI >80 |  $\Delta$  40-90° | Efficiency (%) 96

Photobiological safety

RG0 **0** Risk free

\*Time under 3 h.

Go to page 443 to learn more

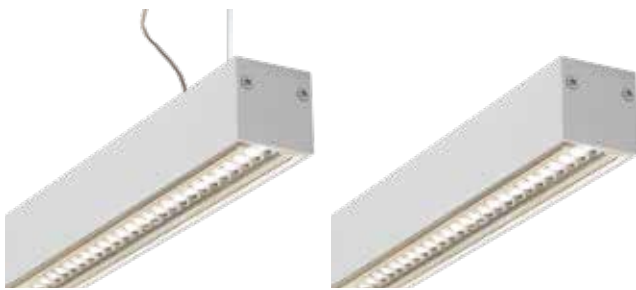

## DOUBLE OPTICS



70°

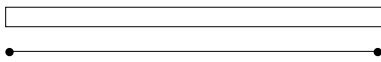

L = 1127 mm

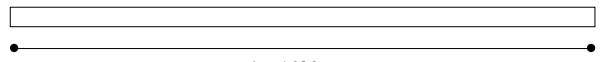

L = 1686 mm

	K	REF.	W	LUMEN			REF. DALI
IP 30	3000	LY4L3YB	26,8 W	3720 lm		2,8	LY4L3DYB
		LY4H3YB	38 W	5600 lm		2,8	LY4H3DYB
UGR 19	4000	LY4L4YB	26,8 W	4000 lm		2,8	LY4L4DYB
		LY4H4YB	38 W	6000 lm		2,8	LY4H4DYB

	K	REF.	W	LUMEN			REF. DALI
IP 30	3000	LY6L3YB	40,2 W	5580 lm		4,1	LY6L3DYB
		LY6H3YB	57 W	8400 lm		4,1	LY6H3DYB
UGR 19	4000	LY6L4YB	40,2 W	6000 lm		4,1	LY6L4DYB
		LY6H4YB	57 W	9000 lm		4,1	LY6H4DYB

RAL9016

RAL9005 Replace "B" by "N" in the reference

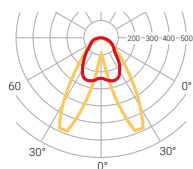

CG-C180  
C90-C270  $\eta=96\%$

Compatible with NormaLINK

# Eyre

Suspended ceiling mounted

Surface ceiling mounted

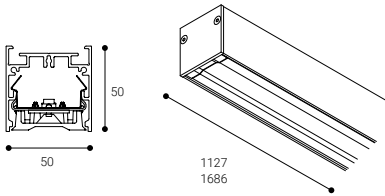

60000 h.  
L70B10

CRI  
>80

Efficiency (%)  
93

Photobiological safety

RG0 **0** Risk free

\*Time under 3 h.

Go to page 443 to learn more

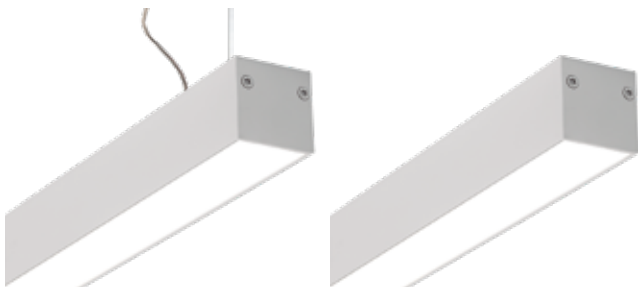

## WALLWASHER DIFFUSER

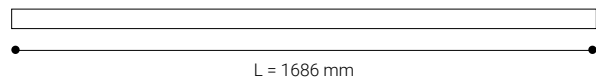
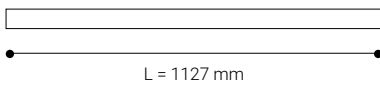

	K	REF.	W	LUMEN			REF. DALI
IP 30	3000	LY4L3AB	26,8 W	3720 lm	○	2,8	LY4L3DAB
		LY4H3AB	38 W	5600 lm	○	2,8	LY4H3DAB
UGR 19	4000	LY4L4AB	26,8 W	4000 lm	○	2,8	LY4L4DAB
		LY4H4AB	38 W	6000 lm	○	2,8	LY4H4DAB

	K	REF.	W	LUMEN			REF. DALI
IP 30	3000	LY6L3AB	40,2 W	5580 lm	○	4,1	LY6L3DAB
		LY6H3AB	57 W	8400 lm	○	4,1	LY6H3DAB
UGR 19	4000	LY6L4AB	40,2 W	6000 lm	○	4,1	LY6L4DAB
		LY6H4AB	57 W	9000 lm	○	4,1	LY6H4DAB

- RAL9016
- RAL7001 Replace "B" by "G" in the reference

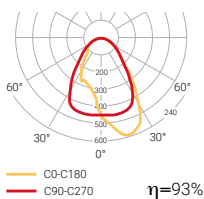

Compatible with NormaLINK

# Eyre

ACCESSORIES

Suspension accessory

	L (m)
<b>1029L2</b>	2
<b>1029L4</b>	4

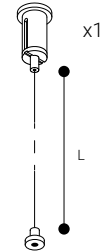

Connection box and power supply cable

	POWER SUPPLY CABLE LENGTH	COLOUR
<b>ETC1029B</b>	2	○
<b>ETC1029N</b>	2	●
<b>ETC10294MB</b>	4	○
<b>ETC10294MN</b>	4	●
<b>ETC10295PB</b>	2	○
<b>ETC10295PN</b>	2	●

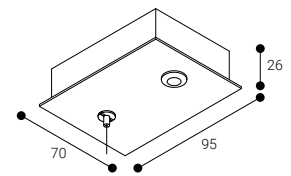

Joining accessory

	COLOUR
<b>LY014</b>	○
 <b>LY0145P</b>	○

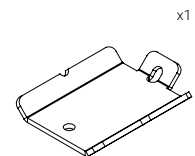

End cover

	COLOUR
<b>LY016B</b>	○
<b>LY016N</b>	●

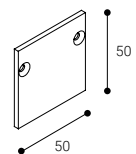



# Trazzo Avant

TRAZZO AVANT is a linear system for surface or suspended installation. Made of extruded aluminium, it is available in pieces of 1125 and 1685 mm long.

The new LED multi reflector system improves the visual confort of the luminaire.

IT IS AVAILABLE IN VERSION

salUZ®

Lighting that takes care of people



Suspended ceiling mounted

Surface ceiling mounted

Ceiling recessed mounted







RAL9016



RAL9005

Ceiling suspended, surface and recessed mounted

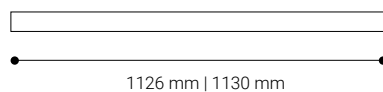

### Three executions, two lengths

A versatile, contemporary architectural solution with the flexibility to transform spaces, shaping atmospheres that require ample, visually attractive lighting which forms part of the whole.





## Trazzo Avant

Installation	Suspended ceiling mounted Surface ceiling mounted Ceiling recessed mounted
Diffuser	⊙ ⊙
Light source	LED
Photobiological safety	0
UGR	16   22
CRI	>80
MacAdam ellipse	3
Beam angle range	74   101
Power range (W)	25,9-57
Colour temperature (°K)	2700   3000   4000   5600   6500
Light range	3345-9000
Power factor	0,95
Efficiency (%)	73
Expectancy	50000 h L70B10   60000 h L70B10
DALI Option	✓
Continuous operation 24h	✓
IP	30   20-44
Class	I
Energy efficiency	B   C   D

⊙ Without diffuser   ⊙ Opal diffuser

Version  
**salUZ®**  
pages 291 and 297

**CRI 360** | For other CRI values,  
please contact us.



Please request technical  
specifications of all the luminaires  
or visit our website.



Without diffuser



Opal diffuser

# Trazzo Avant

Suspended ceiling mounted

Surface ceiling mounted

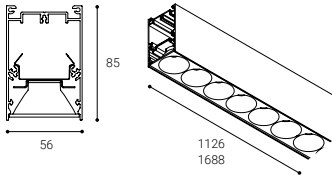

50000 h. L70B10 | CRI >80 | 77° | Efficiency (%) 73

Photobiological safety

RG0 0 Risk free

\*Time under 3 h.

Go to page 443 to learn more



## WITHOUT DIFFUSER

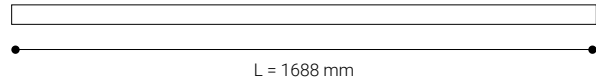
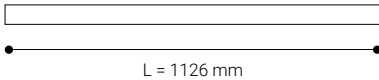

	K	REF.	W	LUMEN			REF. DALI
IP 30	3000	TX4L3RB	26,8 W	3720 lm		2,5	TX4L3DRB
		TX4H3RB	38,0 W	5600 lm		2,5	TX4H3DRB
UGR 16	4000	TX4L4RB	26,8 W	4000 lm		2,5	TX4L4DRB
		TX4H4RB	38,0 W	6000 lm		2,5	TX4H4DRB

	K	REF.	W	LUMEN			REF. DALI
IP 30	3000	TX6L3RB	40,2 W	5580 lm		2,5	TX6L3DRB
		TX6H3RB	57,0 W	8400 lm		2,5	TX6H3DRB
UGR 16	4000	TX6L4RB	40,2 W	6000 lm		2,5	TX6L4DRB
		TX6H4RB	57,0 W	9000 lm		2,5	TX6H4DRB

RAL9016

RAL9005 Replace "B" by "N" in the reference

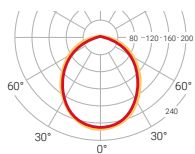

— C0-C180  $\eta=82\%$   
— C90-C270

Compatible with NormaLINK

# Trazzo Avant saLuz®

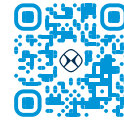

SaLuz® Video  
and more information

Suspended ceiling mounted

Surface ceiling mounted

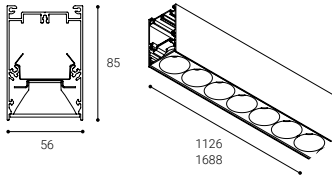

50000 h.  
L70B10

CRI  
>80

77°

Efficiency (%)  
73

Photobiological safety

RG0 **0** Risk free

\*Time under 3 h.

Go to page 443 to learn more



saLuz®

WITHOUT DIFFUSER

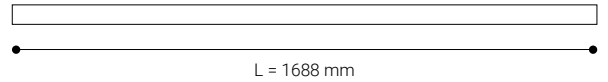
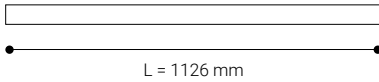

	K	REF.		W	LUMEN		
IP 30	2700-5600	TX4ZRB	●	25,9 W	3345 lm	○	2,5
UGR 16	2700-6500	TX4TWRB	●	25,9 W	3345 lm	○	2,5

	K	REF.		W	LUMEN		
IP 30	2700-6500	TX6TWRB	●	38,9 W	5020 lm	○	2,5
UGR 16							

○ RAL9016

● RAL9005 Replace "B" by "N" in the reference

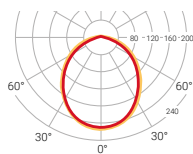

— C0-C180  
— C90-C270  
 $\eta=82\%$

● saLuz® Self-contained

Once the luminaire has been connected to mains, it automatically modifies the intensity and the tone of the light all over the day.

● saLuz® Tunable white

COMPATIBLE WITH NORMALINK

This version makes it possible to modify circadian cycles from Normalink in remote, and also to adapt them to the specific needs of the project.

# Trazzo Avant

Suspended ceiling mounted

Surface ceiling mounted

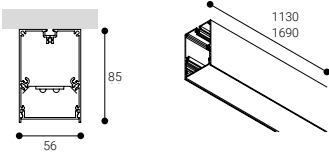

60000 h. L70B10 | CRI >80 | 101° | Efficiency (%) 54,2

Photobiological safety

RG0 0 Risk free

\*Time under 3 h.

Go to page 443 to learn more



## OPAL DIFFUSER

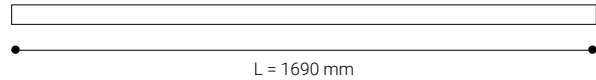
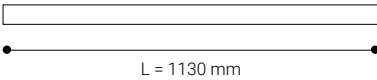

	K	REF.	W	LUMEN			REF. DALI
IP 30	3000	TX4L30B	26,8 W	3720 lm		2,5	TX4L3DOB
		TX4H30B	38,0 W	5600 lm		2,5	TX4H3DOB
UGR 22	4000	TX4L40B	26,8 W	4000 lm		2,5	TX4L4DOB
		TX4H40B	38,0 W	6000 lm		2,5	TX4H4DOB

	K	REF.	W	LUMEN			REF. DALI
IP 30	3000	TX6L30B	40,2 W	5580 lm		2,5	TX6L3DOB
		TX6H30B	57,0 W	8400 lm		2,5	TX6H3DOB
UGR 22	4000	TX6L40B	40,2 W	6000 lm		2,5	TX6L4DOB
		TX6H40B	57,0 W	9000 lm		2,5	TX6H4DOB

- RAL9016
- RAL9005 Replace "B" by "N" in the reference

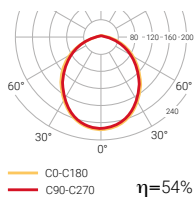

# Trazzo Avant

ACCESSORIES

Suspension accessory

	L (m)	COLOUR
<b>1029L2</b>	2	●
<b>1029L4</b>	4	●

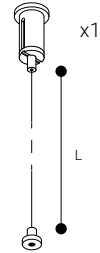

Connection box and power supply cable



	COLOUR
<b>ETC1029B</b>	○
<b>ETC1029N</b>	●
<b>ETC10295PB</b>	○
<b>ETC10295PN</b>	●

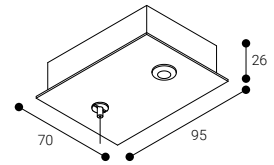

Joining accessory



	COLOUR
<b>TX014</b>	○
<b>TX0145P</b>	○

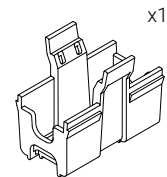

Corner union accessory

	COLOUR
<b>TX006B</b>	○
<b>TX006N</b>	●

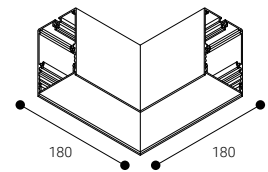

5 poles joint elbow accessory

	COLOUR
<b>TX0065PB</b>	○
<b>TX0065PN</b>	●

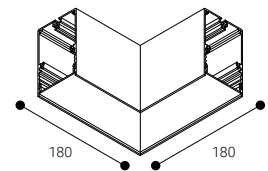

End cover

	COLOUR
<b>TX016B</b>	○
<b>TX016N</b>	●

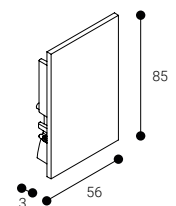



### Beauty and pure lines

An attractive, functional system inspired by the principles of purity and beauty that enhances aesthetic elegance with high performance and comfort. A visual language where sparing lines and modular possibilities offer a homogeneous result with no unwanted shadows.



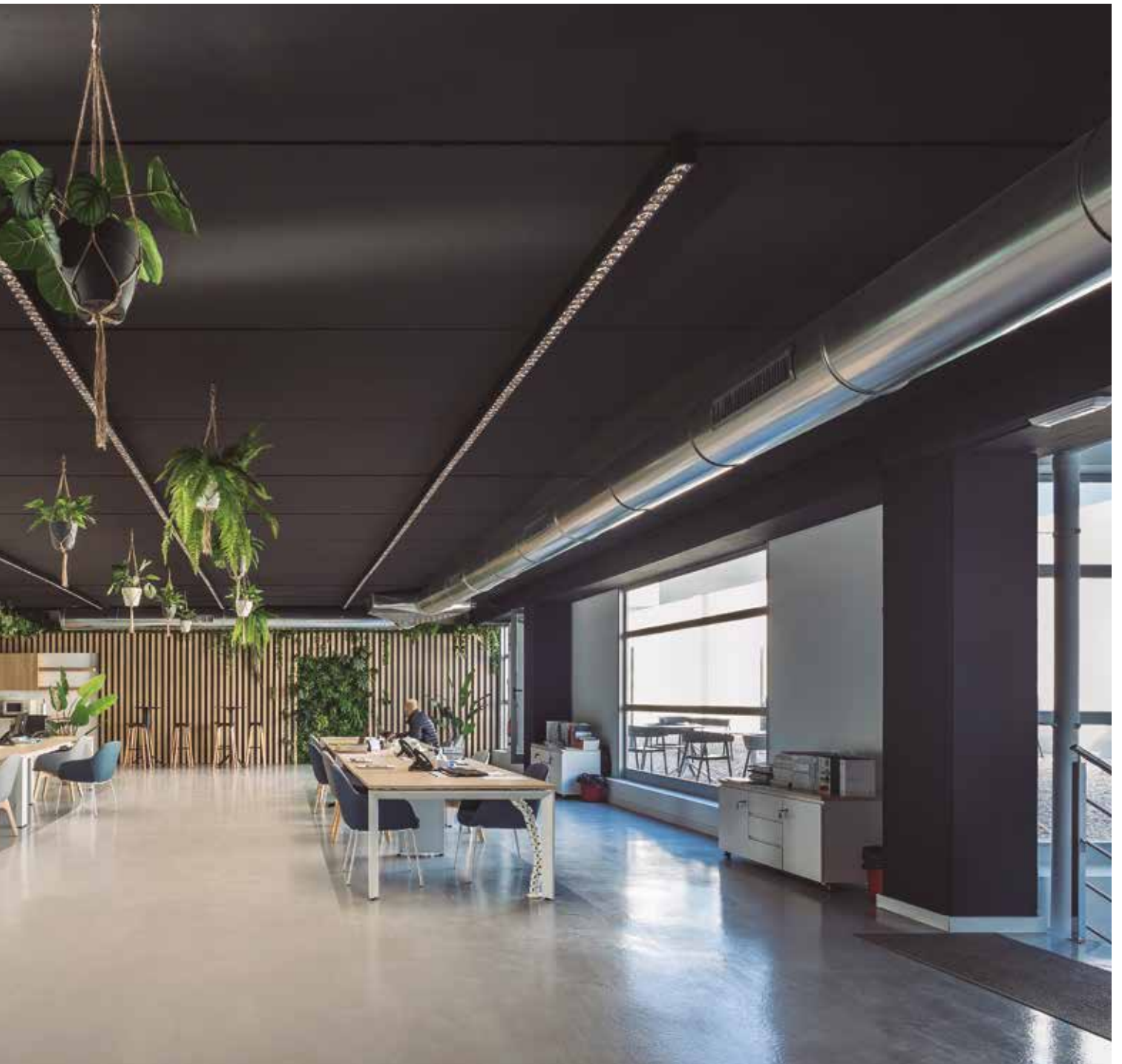

# Trazzo Avant

Ceiling recessed mounted

LED CE ENEC

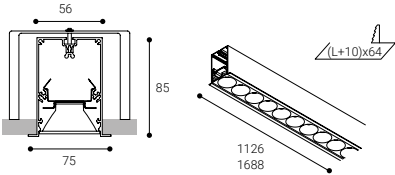

50000 h. L70B10 | CRI >80 | 77° | Efficiency (%) 73

Photobiological safety

RG0 0 Risk free

\*Time under 3h.

Go to page 443 to learn more



## WITHOUT DIFFUSER

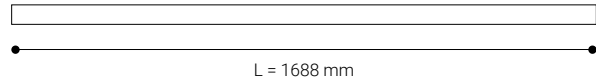
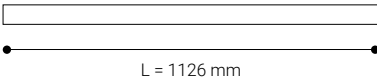

	K	REF.	W	LUMEN			REF. DALI
IP 20-44	3000	TXE4L3RB	26,8 W	3720 lm	○	3,7	TXE4L3DRB
		TXE4H3RB	38,0 W	5600 lm	○	3,7	TXE4H3DRB
UGR 16	4000	TXE4L4RB	26,8 W	4000 lm	○	3,7	TXE4L4DRB
		TXE4H4RB	38,0 W	6000 lm	○	3,7	TXE4H4DRB

	K	REF.	W	LUMEN			REF. DALI
IP 20-44	3000	TXE6L3RB	40,2 W	5580 lm	○	4,4	TXE6L3DRB
		TXE6H3RB	57,0 W	8400 lm	○	4,4	TXE6H3DRB
UGR 16	4000	TXE6L4RB	40,2 W	6000 lm	○	4,4	TXE6L4DRB
		TXE6H4RB	57,0 W	9000 lm	○	4,4	TXE6H4DRB

- RAL9016
- RAL9005 Replace "B" by "N" in the reference

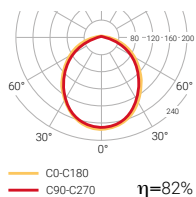

DALI Compatible with NormaLINK



# Trazzo Avant saLuz®



SaLuz® Video  
and more information

Ceiling recessed mounted

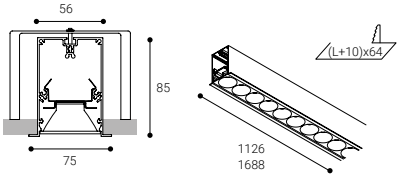

50000 h.  
L70B10

CRI  
>80

77°

Efficiency (%)  
73

Photobiological safety

RG0 **0** Risk free

\*Time under 3 h.

Go to page 443 to learn more



saLuz®

WITHOUT DIFFUSER

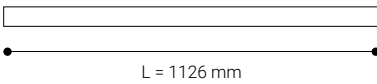

	K	REF.		W	LUMEN		
IP 20-44	2700-6500	TXE4ZRB	●	25,9 W	3345 lm	○	3,7
		TXE4TWRB	●	25,9 W	3345 lm	○	3,7
UGR	16						

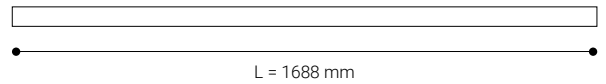

	K	REF.		W	LUMEN		
IP 20-44	2700-6500	TXE6TWRB	●	38,9 W	5020 lm	○	4,4
UGR	16						

- RAL9016
- RAL9005 Replace "B" by "N" in the reference

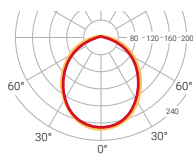

η=82%

● saLuz® Self-contained

Once the luminaire has been connected to mains, it automatically modifies the intensity and the tone of the light all over the day.

● saLuz® Tunable white

COMPATIBLE WITH NORMALINK

This version makes it possible to modify circadian cycles from Normalink in remote, and also to adapt them to the specific needs of the project.

# Trazzo Avant

Ceiling recessed mounted

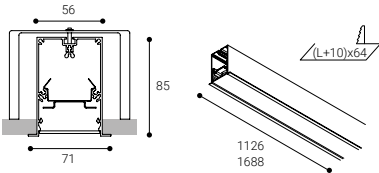

60000 h. L70B10 | CRI >80 | 101° | Efficiency (%) 54,2

Photobiological safety

RG0 0 Risk free

\*Time under 3 h.

Go to page 443 to learn more

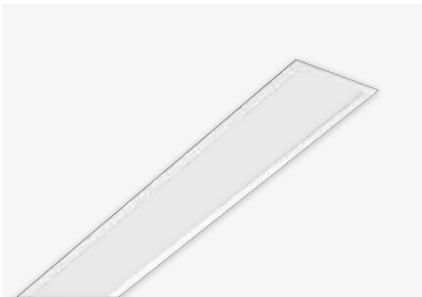

## OPAL DIFFUSER

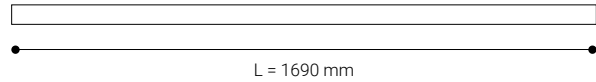
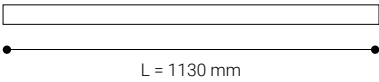

	K	REF.	W	LUMEN			REF. DALI
IP 20-44	3000	TXE4L3OB	26,8 W	3720 lm	○	3,7	TXE4L3DOB
		TXE4H3OB	38,0 W	5600 lm	○	3,7	TXE4H3DOB
UGR 22	4000	TXE4L4OB	26,8 W	4000 lm	○	3,7	TXE4L4DOB
		TXE4H4OB	38,0 W	6000 lm	○	3,7	TXE4H4DOB

	K	REF.	W	LUMEN			REF. DALI
IP 20-44	3000	TXE6L3OB	40,2 W	5580 lm	○	4,4	TXE6L3DOB
		TXE6H3OB	57,0 W	8400 lm	○	4,4	TXE6H3DOB
UGR 22	4000	TXE6L4OB	40,2 W	6000 lm	○	4,4	TXE6L4DOB
		TXE6H4OB	57,0 W	9000 lm	○	4,4	TXE6H4DOB

- RAL9016
- RAL9005 Replace "B" by "N" in the reference

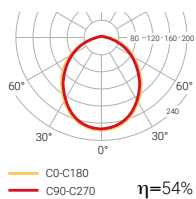

Compatible with NormaLINK

# Trazzo Avant

ACCESSORIES

Joining accessory



	COLOUR
<b>TX014</b>	○
<b>TX0145P</b>	○

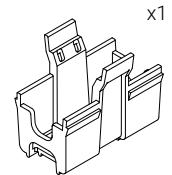

Corner union accessory  
recessed model

	COLOUR
<b>TXE006B</b>	○
<b>TXE006N</b>	●

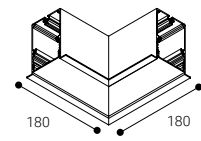

5 poles joint corner accessory  
recessed model

	COLOUR
<b>TXE0065PB</b>	○
<b>TXE0065PN</b>	●

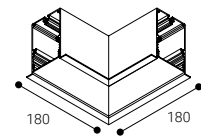

End cover  
recessed model

	COLOUR
<b>TXE016B</b>	○
<b>TXE016N</b>	●

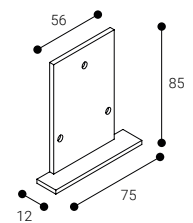



# Trazzo

TRAZZO is a system which enables to make continuous lines of light with direct and indirect lighting. It is made of extruded and anodized aluminium profile.

Two versions,  
multiple possibilities

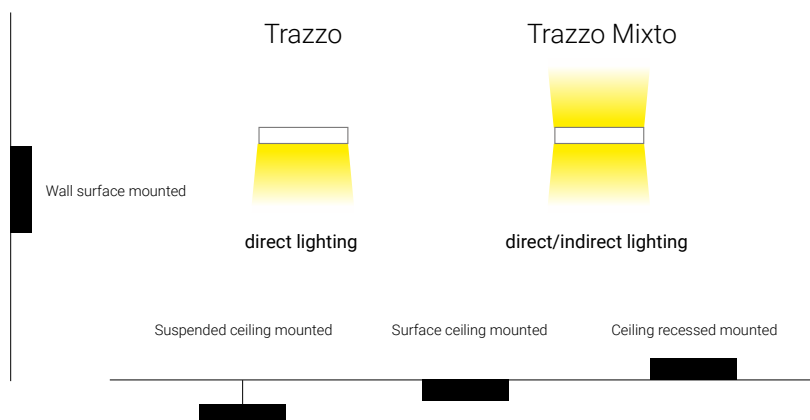



It can be mounted in a wall or ceiling and can also be suspended or recessed.



Opal diffuser



Sheets diffuser



Wallwasher diffuser

Its lighting variants include an opal polycarbonate diffuser and a matt anodised aluminium diffuser for optimal visual comfort as well as wallwasher.



## Trazzo 70

## Trazo Mixto

Installation

Surface ceiling mounted  
Wall surface mounted  
Suspended ceiling mounted  
Ceiling recessed mounted

Surface ceiling mounted  
Suspended ceiling mounted

Diffuser



Light source

LED

LED

Photobiological safety

0

0

UGR

19 | 22

19 | 22

CRI

>80

>80

MacAdam ellipse

3

3

Beam angle range

70-100

70-100

Power range (W)

26,8-57

46,9-104,5

Colour temperature (°K)

3000 | 4000

3000 | 4000

Light range

3720-9000

6510-16500

Power factor

0,95

0,95

Efficiency (%)

78,7

71,5

Expectancy

60000 h L70B10

60000 h L70B10

DALI Option



Continuous operation 24h



IP

30 | 20-44

30

Class

I

I

Ideal cut out (mm)

(L+10)x87

Energy efficiency

B | C

D

● Opal diffuser

⊗ Wallwasher diffuser

⊞ Sheets diffuser



CRI 360

For other CRI values,  
please contact us.



RAL9016



RAL7001





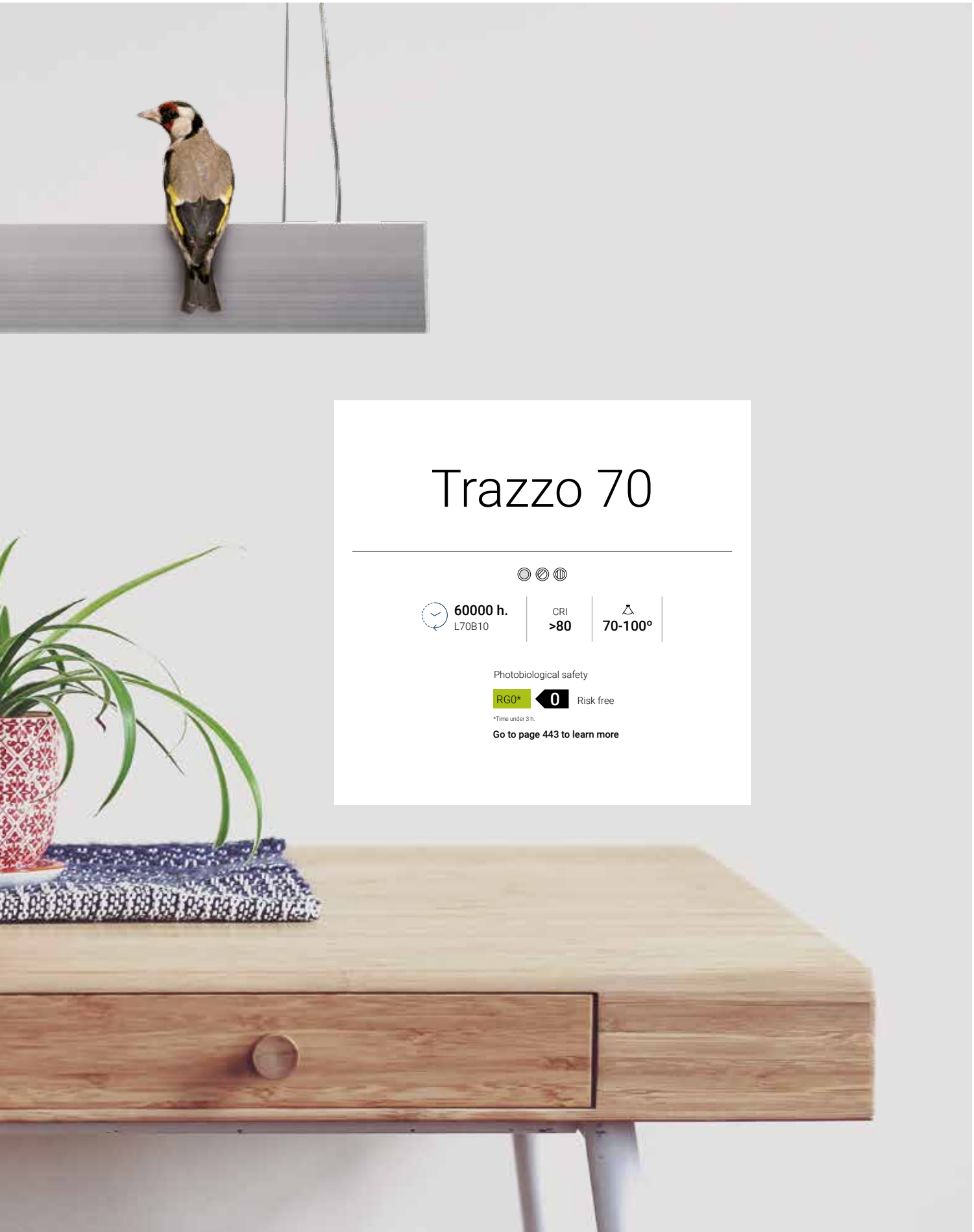

# Trazzo 70



**60000 h.**  
L70B10

CRI  
**>80**

 **70-100°**

Photobiological safety

**RG0\***  Risk free

\*Time under 3 h.

**Go to page 443 to learn more**

# Trazzo 70

Surface ceiling mounted

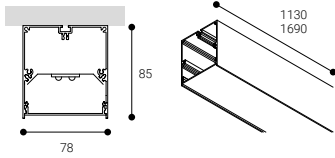
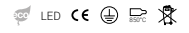

<b>60000 h.</b> L70B10	CRI <b>&gt;80</b>	<b>100°</b>	Efficiency (%) <b>62,5</b>
---------------------------	----------------------	-------------	-------------------------------

Photobiological safety

**RG0** Risk free

\*Time under 3 h.

[Go to page 443 to learn more](#)



## OPAL DIFFUSER

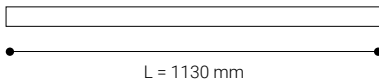

	K	REF.	W	LUMEN			REF. DALI
IP 30	3000	<b>T7A4L30B</b>	26,8 W	3720 lm		2,8	<b>T7A4L3DOB</b>
		<b>T7A4H30B</b>	38,0 W	5600 lm		2,8	<b>T7A4H3DOB</b>
UGR 22	4000	<b>T7A4L40B</b>	26,8 W	4000 lm		2,8	<b>T7A4L4DOB</b>
		<b>T7A4H40B</b>	38,0 W	6000 lm		2,8	<b>T7A4H4DOB</b>

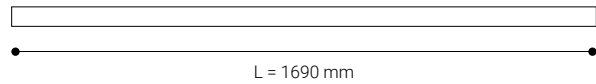

	K	REF.	W	LUMEN			REF. DALI
IP 30	3000	<b>T7A6L30B</b>	40,2 W	5580 lm		4,1	<b>T7A6L3DOB</b>
		<b>T7A6H30B</b>	57,0 W	8400 lm		4,1	<b>T7A6H3DOB</b>
UGR 22	4000	<b>T7A6L40B</b>	40,2 W	6000 lm		4,1	<b>T7A6L4DOB</b>
		<b>T7A6H40B</b>	57,0 W	9000 lm		4,1	<b>T7A6H4DOB</b>

- RAL9016
- RAL7001 Replace "B" by "G" in the reference

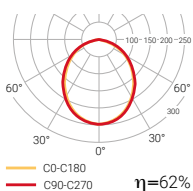

# Trazzo 70

Surface ceiling mounted

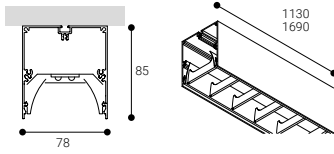

<b>60000 h.</b> L70B10	CRI <b>&gt;80</b>	<b>70°</b>	Efficiency (%) <b>75,4</b>
---------------------------	----------------------	------------	-------------------------------

Photobiological safety

**RG0** **0** Risk free

Go to page 443 to learn more



## LOUVERS DIFFUSER

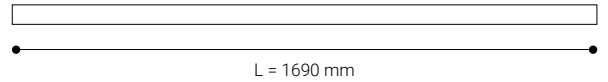
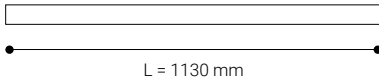

	K	REF.	W	LUMEN			REF. DALI
IP 30		<b>T7A4L3LB</b>	26,8 W	3720 lm		2,8	<b>T7A4L3DLB</b>
		<b>T7A4H3LB</b>	38,0 W	5600 lm		2,8	<b>T7A4H3DLB</b>
UGR 19		<b>T7A4L4LB</b>	26,8 W	4000 lm		2,8	<b>T7A4L4DLB</b>
		<b>T7A4H4LB</b>	38,0 W	6000 lm		2,8	<b>T7A4H4DLB</b>

	K	REF.	W	LUMEN			REF. DALI
IP 30		<b>T7A6L3LB</b>	40,2 W	5580 lm		4,1	<b>T7A6L3DLB</b>
		<b>T7A6H3LB</b>	57,0 W	8400 lm		4,1	<b>T7A6H3DLB</b>
UGR 19		<b>T7A6L4LB</b>	40,2 W	6000 lm		4,1	<b>T7A6L4DLB</b>
		<b>T7A6H4LB</b>	57,0 W	9000 lm		4,1	<b>T7A6H4DLB</b>

- RAL9016
- RAL7001 Replace "B" by "G" in the reference

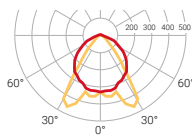

— CO-C180  
— C90-C270  $\eta=75\%$



# Trazzo 70

Surface ceiling mounted

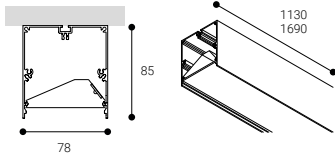

60000 h. L70B10 | CRI >80 | 90° | Efficiency (%) 78,77

Photobiological safety

RG0 0 Risk free

\*Time under 3 h.

Go to page 443 to learn more



## WALLWASHER DIFFUSER

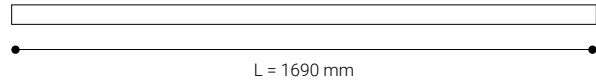
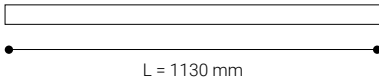

	K	REF.	W	LUMEN			REF. DALI
IP 30	3000	T7A4L3AB	26,8 W	3720 lm	○ 2,8		T7A4L3DAB
		T7A4H3AB	38,0 W	5600 lm	○ 2,8		T7A4H3DAB
UGR 19	4000	T7A4L4AB	26,8 W	4000 lm	○ 2,8		T7A4L4DAB
		T7A4H4AB	38,0 W	6000 lm	○ 2,8		T7A4H4DAB

	K	REF.	W	LUMEN			REF. DALI
IP 30	3000	T7A6L3AB	40,2 W	5580 lm	○ 4,1		T7A6L3DAB
		T7A6H3AB	57,0 W	8400 lm	○ 4,1		T7A6H3DAB
UGR 19	4000	T7A6L4AB	40,2 W	6000 lm	○ 4,1		T7A6L4DAB
		T7A6H4AB	57,0 W	9000 lm	○ 4,1		T7A6H4DAB

- RAL9016
- RAL7001 Replace "B" by "G" in the reference

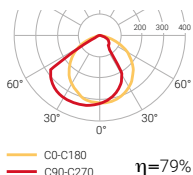

# Trazzo 70

Suspended ceiling mounted

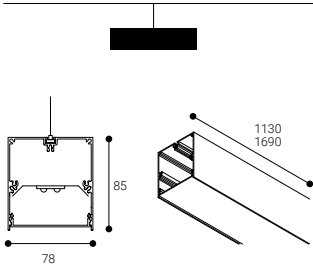

60000 h. L70B10 | CRI >80 |  $\Delta$  100° | Efficiency (%) 62,5

Photobiological safety

RG0 **0** Risk free

\*Time under 3 h.

Go to page 443 to learn more



## OPAL DIFFUSER

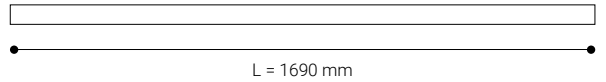
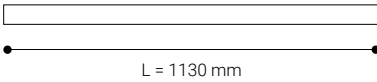

	K	REF.	W	LUMEN			REF. DALI
IP 30	3000	T7S4L3OB	26,8 W	3720 lm		2,8	T7S4L3DOB
		T7S4H3OB	38,0 W	5600 lm		2,8	T7S4H3DOB
UGR 22	4000	T7S4L4OB	26,8 W	4000 lm		2,8	T7S4L4DOB
		T7S4H4OB	38,0 W	6000 lm		2,8	T7S4H4DOB

	K	REF.	W	LUMEN			REF. DALI
IP 30	3000	T7S6L3OB	40,2 W	5580 lm		4,1	T7S6L3DOB
		T7S6H3OB	57,0 W	8400 lm		4,1	T7S6H3DOB
UGR 22	4000	T7S6L4OB	40,2 W	6000 lm		4,1	T7S6L4DOB
		T7S6H4OB	57,0 W	9000 lm		4,1	T7S6H4DOB

- RAL9016
- RAL7001 Replace "B" by "G" in the reference

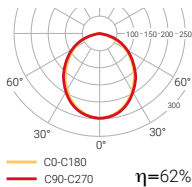

# Trazzo 70

Suspended ceiling mounted

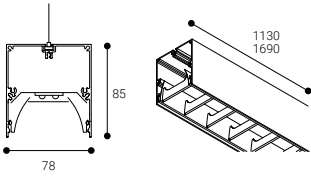

60000 h.  
L70B10

CRI  
>80

70°

Efficiency (%)  
75,4

Photobiological safety

RG0 **0** Risk free

\*Time under 3 h.

Go to page 443 to learn more



## LOUVERS DIFFUSER

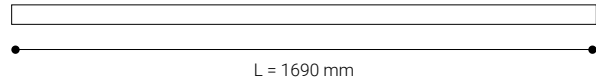
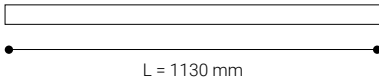

	K	REF.	W	LUMEN			REF. DALI
IP 30	3000	T7S4L3LB	26,8 W	3720 lm			T7S4L3DLB
		T7S4H3LB	38,0 W	5600 lm			T7S4H3DLB
UGR 19	4000	T7S4L4LB	26,8 W	4000 lm			T7S4L4DLB
		T7S4H4LB	38,0 W	6000 lm			T7S4H4DLB

	K	REF.	W	LUMEN			REF. DALI
IP 30	3000	T7S6L3LB	40,2 W	5580 lm			T7S6L3DLB
		T7S6H3LB	57,0 W	8400 lm			T7S6H3DLB
UGR 19	4000	T7S6L4LB	40,2 W	6000 lm			T7S6L4DLB
		T7S6H4LB	57,0 W	9000 lm			T7S6H4DLB

- RAL9016
- RAL7001 Replace "B" by "G" in the reference

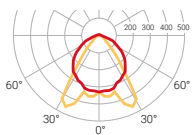

CO-C180  
C90-C270  $\eta=75\%$



# Trazzo 70

Suspended ceiling mounted

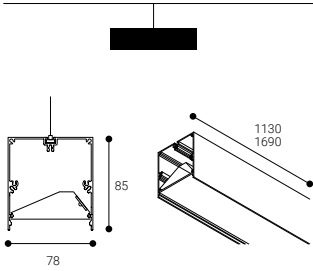

60000 h.  
L70B10

CRI  
>80

90°

Efficiency (%)  
78,77

Photobiological safety

RG0 **0** Risk free

\*Time under 3 h.

Go to page 443 to learn more



## WALLWASHER DIFFUSER

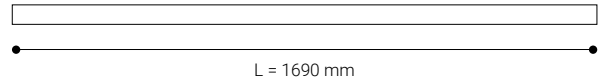
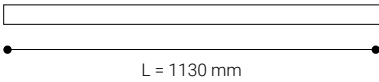

	K	REF.	W	LUMEN			REF. DALI
IP 30	3000	T7S4L3AB	26,8 W	3720 lm		2,8	T7S4L3DAB
		T7S4H3AB	38,0 W	5600 lm		2,8	T7S4H3DAB
UGR 19	4000	T7S4L4AB	26,8 W	4000 lm		2,8	T7S4L4DAB
		T7S4H4AB	38,0 W	6000 lm		2,8	T7S4H4DAB

	K	REF.	W	LUMEN			REF. DALI
IP 30	3000	T7S6L3AB	40,2 W	5580 lm		4,1	T7S6L3DAB
		T7S6H3AB	57,0 W	8400 lm		4,1	T7S6H3DAB
UGR 19	4000	T7S6L4AB	40,2 W	6000 lm		4,1	T7S6L4DAB
		T7S6H4AB	57,0 W	9000 lm		4,1	T7S6H4DAB

- RAL9016
- RAL7001 Replace "B" by "G" in the reference

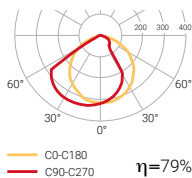

# Trazzo 70

LED CE ENEC

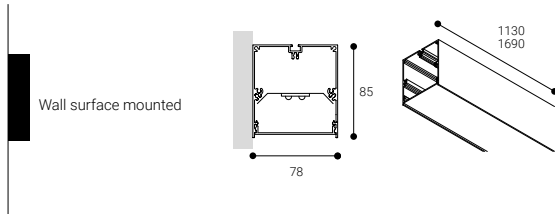

60000 h. L70B10 | CRI >80 | 100° | Efficiency (%) 62,5

Photobiological safety

RG0 0 Risk free

\*Time under 3 h.

Go to page 443 to learn more



## OPAL DIFFUSER

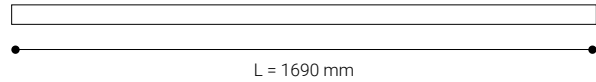
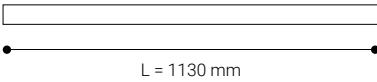

	K	REF.	W	LUMEN	⊙	⊙	REF. DALI
IP 30	3000	T7P4L30B	26,8 W	3720 lm	⊙	2,8	T7P4L3DOB
		T7P4H30B	38,0 W	5600 lm	⊙	2,8	T7P4H3DOB
UGR 22	4000	T7P4L40B	26,8 W	4000 lm	⊙	2,8	T7P4L4DOB
		T7P4H40B	38,0 W	6000 lm	⊙	2,8	T7P4H4DOB

	K	REF.	W	LUMEN	⊙	⊙	REF. DALI
IP 30	3000	T7P6L30B	40,2 W	5580 lm	⊙	4,1	T7P6L3DOB
		T7P6H30B	57,0 W	8400 lm	⊙	4,1	T7P6H3DOB
UGR 22	4000	T7P6L40B	40,2 W	6000 lm	⊙	4,1	T7P6L4DOB
		T7P6H40B	57,0 W	9000 lm	⊙	4,1	T7P6H4DOB

- RAL9016
- RAL7001 Replace "B" by "G" in the reference

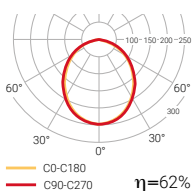

DALI Compatible with **NormalINK**



# Trazzo 70

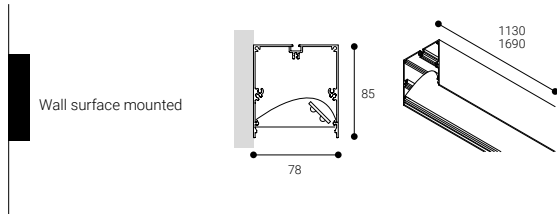

60000 h. L70B10 | CRI >80 |  $\Delta$  90° | Efficiency (%) 78,77

Photobiological safety  
**RG0** **0** Risk free  
\*Time under 3 h.  
 Go to page 443 to learn more



## WALLWASHER DIFFUSER

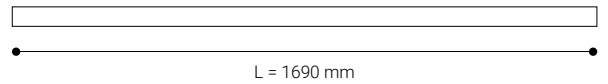
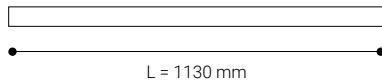

	K	REF.	W	LUMEN			REF. DALI
IP 30	3000	T7P4L3AB	26,8 W	3720 lm		2,8	T7P4L3DAB
		T7P4H3AB	38,0 W	5600 lm		2,8	T7P4H3DAB
UGR 19	4000	T7P4L4AB	26,8 W	4000 lm		2,8	T7P4L4DAB
		T7P4H4AB	38,0 W	6000 lm		2,8	T7P4H4DAB

	K	REF.	W	LUMEN			REF. DALI
IP 30	3000	T7P6L3AB	40,2 W	5580 lm		4,1	T7P6L3DAB
		T7P6H3AB	57,0 W	8400 lm		4,1	T7P6H3DAB
UGR 19	4000	T7P6L4AB	40,2 W	6000 lm		4,1	T7P6L4DAB
		T7P6H4AB	57,0 W	9000 lm		4,1	T7P6H4DAB

- RAL9016
- RAL7001 Replace "B" by "G" in the reference

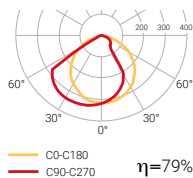

# Trazzo 70

Ceiling recessed mounted

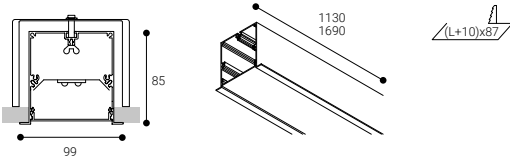

60000 h. L70B10 | CRI >80 | 100° | Efficiency (%) 62,5

Photobiological safety

RG0 0 Risk free

\*Time under 3 h.

Go to page 443 to learn more



## OPAL DIFFUSER

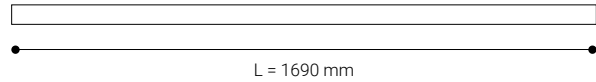
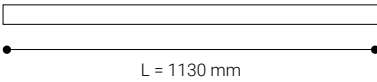

	K	REF.	W	LUMEN			REF. DALI
IP 20-44	3000	T7E4L30B	26,8 W	3720 lm		2,8	T7E4L3DOB
		T7E4H30B	38,0 W	5600 lm		2,8	T7E4H3DOB
UGR 22	4000	T7E4L40B	26,8 W	4000 lm		2,8	T7E4L4DOB
		T7E4H40B	38,0 W	6000 lm		2,8	T7E4H4DOB

	K	REF.	W	LUMEN			REF. DALI
IP 20-44	3000	T7E6L30B	40,2 W	5580 lm		4,1	T7E6L3DOB
		T7E6H30B	57,0 W	8400 lm		4,1	T7E6H3DOB
UGR 22	4000	T7E6L40B	40,2 W	6000 lm		4,1	T7E6L4DOB
		T7E6H40B	57,0 W	9000 lm		4,1	T7E6H4DOB

- RAL9016
- RAL7001 Replace "B" by "G" in the reference

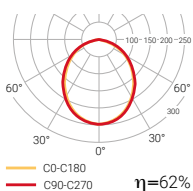

# Trazzo 70

Ceiling recessed mounted

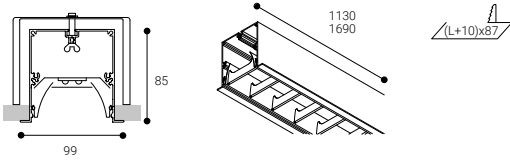

60000 h. L70B10 | CRI >80 |  $70 < \theta < 90^\circ$  | Efficiency (%) 75,4

Photobiological safety

RG0 **0** Risk free

\*Time under 3 h.

Go to page 443 to learn more



## LOUVERS DIFFUSER

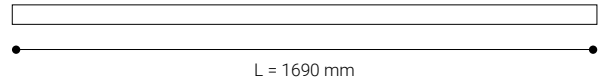
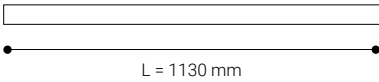

	K	REF.	W	LUMEN			REF. DALI
IP 20-44	3000	T7E4L3LB	26,8 W	3720 lm		2,8	T7E4L3DLB
		T7E4H3LB	38,0 W	5600 lm		2,8	T7E4H3DLB
UGR 19	4000	T7E4L4LB	26,8 W	4000 lm		2,8	T7E4L4DLB
		T7E4H4LB	38,0 W	6000 lm		2,8	T7E4H4DLB

	K	REF.	W	LUMEN			REF. DALI
IP 30	3000	T7E6L3LB	40,2 W	5580 lm		4,1	T7E6L3DLB
		T7E6H3LB	57,0 W	8400 lm		4,1	T7E6H3DLB
UGR 19	4000	T7E6L4LB	40,2 W	6000 lm		4,1	T7E6L4DLB
		T7E6H4LB	57,0 W	9000 lm		4,1	T7E6H4DLB

- RAL9016
- RAL7001 Replace "B" by "G" in the reference

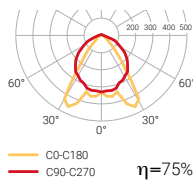

Compatible with NormaLINK

# Trazzo 70

Ceiling recessed mounted

LED CE ENEC

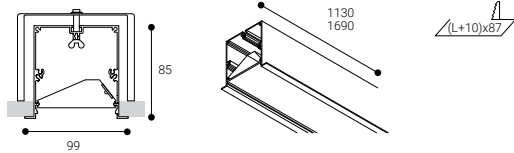

60000 h. L70B10 | CRI >80 | 90° | Efficiency (%) 78,77

Photobiological safety

RG0 0 Risk free

\*Time under 3 h.

Go to page 443 to learn more



## WALLWASHER DIFFUSER

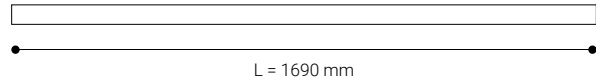
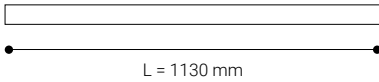

	K	REF.	W	LUMEN			REF. DALI
IP 20-44	3000	T7E4L3AB	26,8 W	3720 lm	○	2,8	T7E4L3DAB
		T7E4H3AB	38,0 W	5600 lm	○	2,8	T7E4H3DAB
UGR 19	4000	T7E4L4AB	26,8 W	4000 lm	○	2,8	T7E4L4DAB
		T7E4H4AB	38,0 W	6000 lm	○	2,8	T7E4H4DAB

	K	REF.	W	LUMEN			REF. DALI
IP 20-44	3000	T7E6L3AB	40,2 W	5580 lm	○	4,1	T7E6L3DAB
		T7E6H3AB	57,0 W	8400 lm	○	4,1	T7E6H3DAB
UGR 19	4000	T7E6L4AB	40,2 W	6000 lm	○	4,1	T7E6L4DAB
		T7E6H4AB	57,0 W	9000 lm	○	4,1	T7E6H4DAB

- RAL9016
- RAL7001 Replace "B" by "G" in the reference

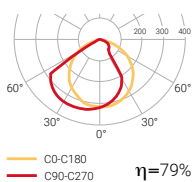

DALI Compatible with NormaLINK

# Trazzo 70

ACCESSORIES

Suspension accessory

	L (m)	COLOUR
<b>1029L2</b>	2	●
<b>1029L4</b>	4	●

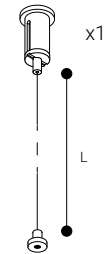

Connection box and power supply cable

	POWER SUPPLY CABLE LENGTH	COLOUR
<b>ETC1029B</b>	2	○
<b>ETC1029G</b>	2	●
<b>ETC10294MB</b>	4	○
<b>ETC10294MG</b>	4	●

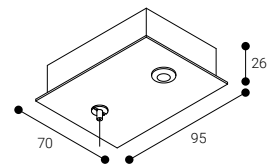

<b>ETC10295PB</b>	2	
<b>ETC10295PG</b>	2	●
<b>ETC10295P4MB</b>	4	○
<b>ETC10295P4MG</b>	4	●

L corner accessory

	COLOUR
<b>TZ70D006B</b>	○
<b>TZ70D006G</b>	●

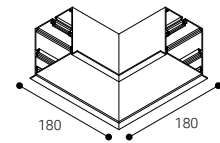

L corner accessory for recessed units

	COLOUR
<b>TZ70E006B</b>	○
<b>TZ70E006G</b>	●

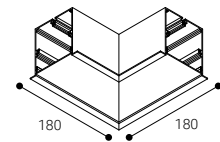

Joining accessory

	COLOUR
<b>TZ70D014</b>	●

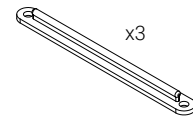

End cover

	COLOUR
<b>TZ70D016B</b>	○
<b>TZ70D016G</b>	●

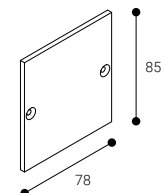

End cover recessed model

	COLOUR
<b>TZ70E016B</b>	○
<b>TZ70E016G</b>	●

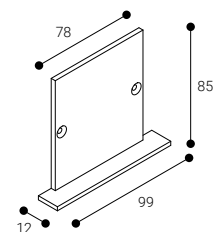



"La técnica lo aprendí en los cursos,  
la profesión no la enseñó mi padre, sí  
Dr. Juan Antonio Robles Herrera".

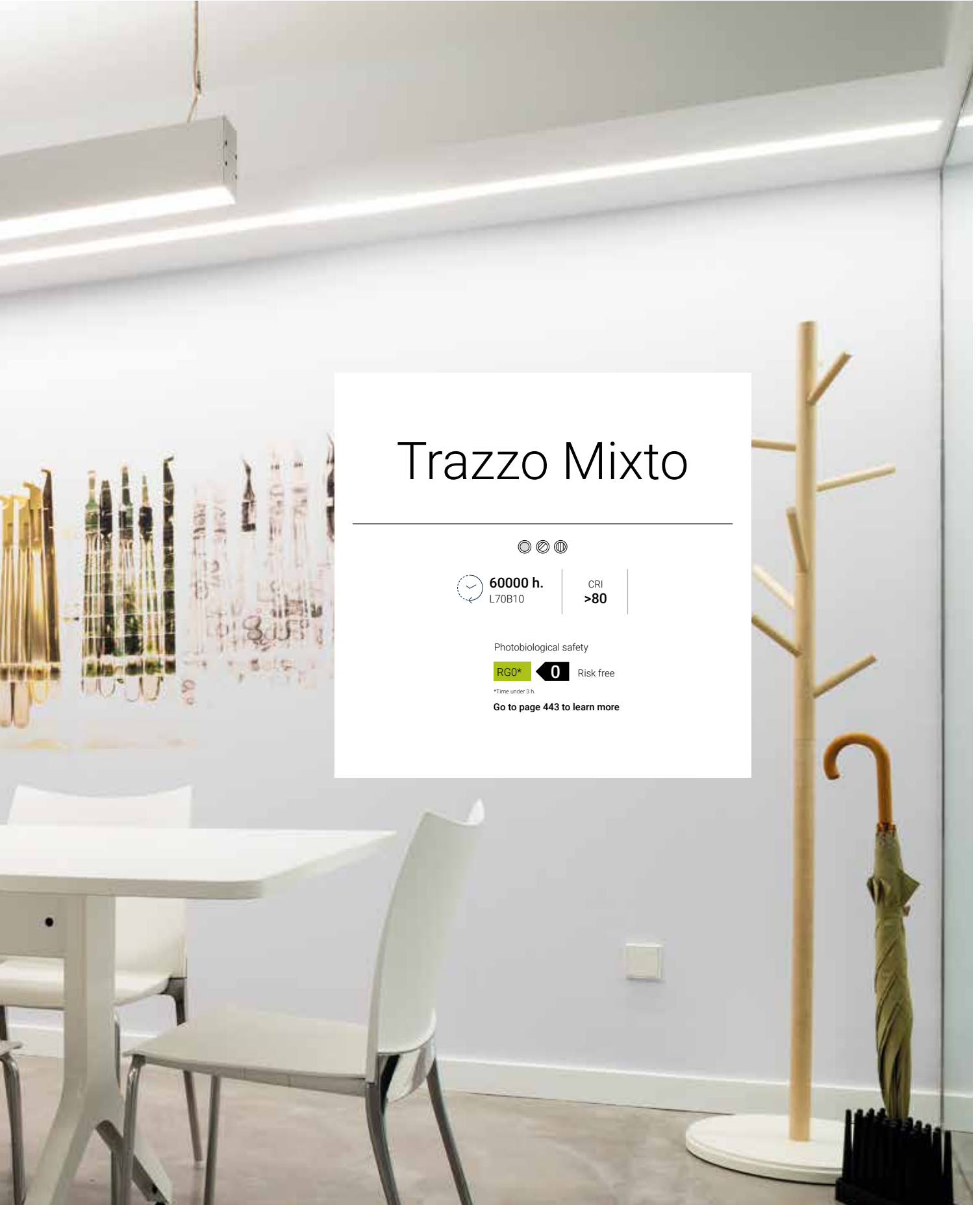

# Trazzo Mixto



**60000 h.**  
L70B10

CRI  
**>80**

Photobiological safety

**RG0\*** **0** Risk free

\*Time under 3 h.

**Go to page 443 to learn more**

# Trazzo Mixto

Suspended ceiling mounted

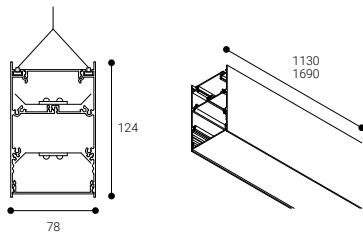

60000 h. L70B10 | CRI >80 | 100° | Efficiency (%) 63,3

Photobiological safety

RG0 0 Risk free

\*Time under 3 h.

Go to page 443 to learn more



## OPAL DIFFUSER

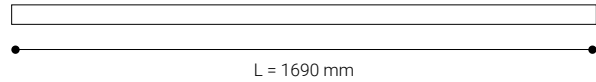
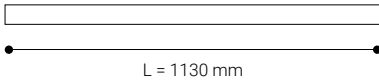

	K	REF.	W	LUMEN			REF. DALI
IP 30	3000	TMS4L30B	46,9 W	6510 lm			TMS4L3DOB
		TMS4H30B	66,5 W	9800 lm			TMS4H3DOB
UGR 22	4000	TMS4L40B	46,9 W	7000 lm			TMS4L4DOB
		TMS4H40B	66,5 W	10500 lm			TMS4H4DOB

	K	REF.	W	LUMEN			REF. DALI
IP 30	3000	TMS6L30B	73,7 W	10230 lm			TMS6L3DOB
		TMS6H30B	104,5 W	15400 lm			TMS6H3DOB
UGR 22	4000	TMS6L40B	73,7 W	11000 lm			TMS6L4DOB
		TMS6H40B	104,5 W	16500 lm			TMS6H4DOB

- RAL9016
- RAL7001 Replace "B" by "G" in the reference

Direct lighting

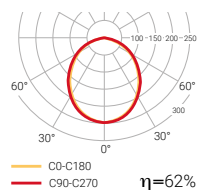

Indirect lighting

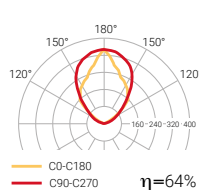



# Trazzo Mixto

Suspended ceiling mounted

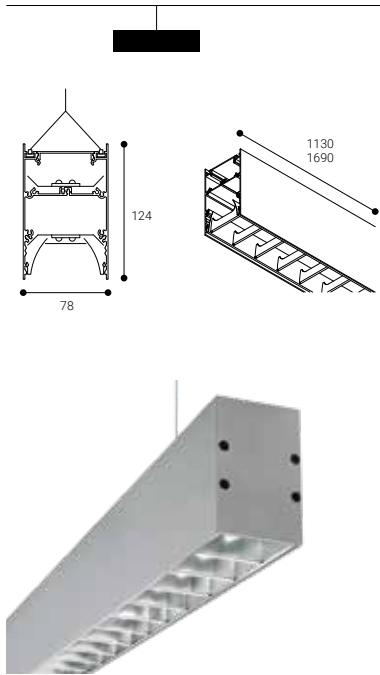

60000 h.  
L70B10

CRI  
>80

70°

Efficiency (%)  
69,8

Photobiological safety

RG0 **0** Risk free

\*Time under 3 h.

Go to page 443 to learn more

## LOUVERS DIFFUSER

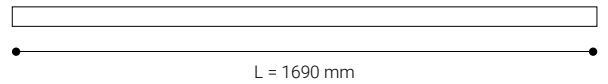
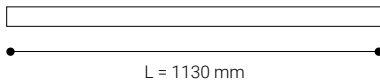

	K	REF.	W	LUMEN			REF. DALI
IP 30	3000	TMS4L3LB	46,9 W	6510 lm			TMS4L3DLB
		TMS4H3LB	66,5 W	9800 lm			TMS4H3DLB
UGR 19	4000	TMS4L4LB	46,9 W	7000 lm			TMS4L4DLB
		TMS4H4LB	66,5 W	10500 lm			TMS4H4DLB

	K	REF.	W	LUMEN			REF. DALI
IP 30	3000	TMS6L3LB	73,7 W	10230 lm			TMS6L3DLB
		TMS6H3LB	104,5 W	15400 lm			TMS6H3DLB
UGR 19	4000	TMS6L4LB	73,7 W	11000 lm			TMS6L4DLB
		TMS6H4LB	104,5 W	16500 lm			TMS6H4DLB

- RAL9016
- RAL7001 Replace "B" by "G" in the reference

Direct lighting

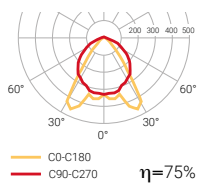

Indirect lighting

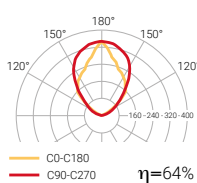

# Trazzo Mixto

Suspended ceiling mounted

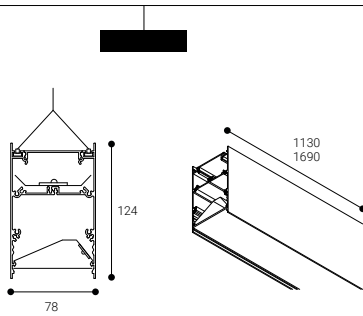

60000 h. L70B10 | CRI >80 | 90° | Efficiency (%) 71,5

Photobiological safety

RG0 0 Risk free

\*Time under 3 h.

Go to page 443 to learn more



## WALLWASHER DIFFUSER

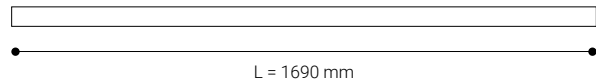
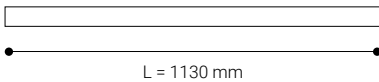

	K	REF.	W	LUMEN	Beam	REF. DALI
IP 30	3000	TMS4L3AB	46,9 W	6510 lm	4,8	TMS4L3DAB
		TMS4H3AB	66,5 W	9800 lm	4,8	TMS4H3DAB
UGR 19	4000	TMS4L4AB	46,9 W	7000 lm	4,8	TMS4L4DAB
		TMS4H4AB	66,5 W	10500 lm	4,8	TMS4H4DAB

	K	REF.	W	LUMEN	Beam	REF. DALI
IP 30	3000	TMS6L3AB	73,7 W	10230 lm	7,1	TMS6L3DAB
		TMS6H3AB	104,5 W	15400 lm	7,1	TMS6H3DAB
UGR 19	4000	TMS6L4AB	73,7 W	11000 lm	7,1	TMS6L4DAB
		TMS6H4AB	104,5 W	16500 lm	7,1	TMS6H4DAB

- RAL9016
- RAL7001 Replace "B" by "G" in the reference

Direct lighting

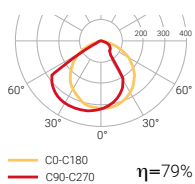

Indirect lighting

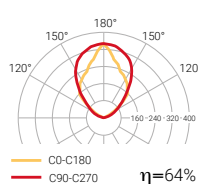

# Trazzo Mixto

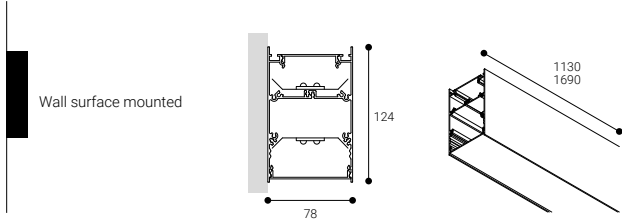

60000 h. L70B10 | CRI >80 |  $\Delta$  100° | Efficiency (%) 63,3

Photobiological safety  
**RG0** **0** Risk free  
\*Time under 3 h.  
 Go to page 443 to learn more



## OPAL DIFFUSER

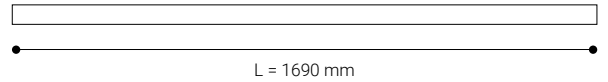
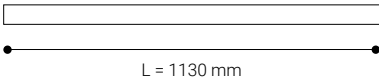

	K	REF.	W	LUMEN			REF. DALI
IP 30	3000	TMP4L30B	46,9 W	6510 lm			TMP4L3DOB
		TMP4H30B	66,5 W	9800 lm			TMP4H3DOB
UGR 22	4000	TMP4L40B	46,9 W	7000 lm			TMP4L4DOB
		TMP4H40B	66,5 W	10500 lm			TMP4H4DOB

	K	REF.	W	LUMEN			REF. DALI
IP 30	3000	TMP6L30B	73,7 W	10230 lm			TMP6L3DOB
		TMP6H30B	104,5 W	15400 lm			TMP6H3DOB
UGR 22	4000	TMP6L40B	73,7 W	11000 lm			TMP6L4DOB
		TMP6H40B	104,5 W	16500 lm			TMP6H4DOB

- RAL9016
- RAL7001 Replace "B" by "G" in the reference

### Direct lighting

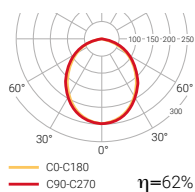

### Indirect lighting

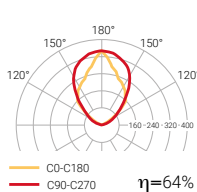

# Trazzo Mixto

LED CE ENEC

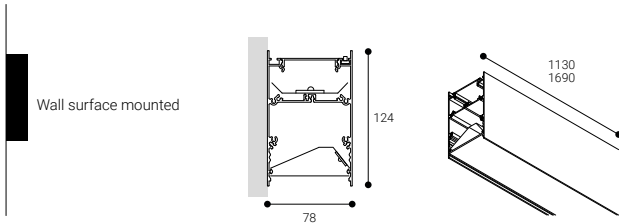

60000 h. L70B10 | CRI >80 | 90° | Efficiency (%) 71,5

Photobiological safety  
**RG0** **0** Risk free  
\*Time under 3 h.  
 Go to page 443 to learn more



## WALLWASHER DIFFUSER

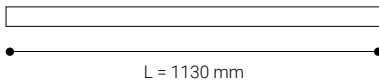

	K	REF.	W	LUMEN	⊙	⊙	REF. DALI
IP 30	3000	TMP4L3AB	46,9 W	6510 lm	⊙	4,8	TMP4L3DAB
		TMP4H3AB	66,5 W	9800 lm	⊙	4,8	TMP4H3DAB
UGR 19	4000	TMP4L4AB	46,9 W	7000 lm	⊙	4,8	TMP4L4DAB
		TMP4H4AB	66,5 W	10500 lm	⊙	4,8	TMP4H4DAB

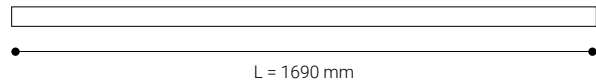

	K	REF.	W	LUMEN	⊙	⊙	REF. DALI
IP 30	3000	TMP6L3AB	73,7 W	10230 lm	⊙	7,1	TMP6L3DAB
		TMP6H3AB	104,5 W	15400 lm	⊙	7,1	TMP6H3DAB
UGR 22	4000	TMP6L4AB	73,7 W	11000 lm	⊙	7,1	TMP6L4DAB
		TMP6H4AB	104,5 W	16500 lm	⊙	7,1	TMP6H4DAB

- RAL9016
- RAL7001 Replace "B" by "G" in the reference

### Direct lighting

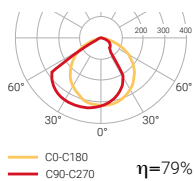

### Indirect lighting

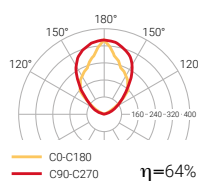

DALI Compatible with NormaLINK

# Trazzo Mixto

ACCESSORIES

Suspension accessory

	L (m)	COLOUR
<b>1029TZ70</b>	2	Ⓐ

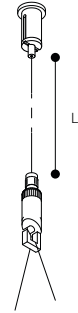

Connection box and power supply cable

	HOSE LENGTH	COLOUR
<b>ETC1029B</b>	2	○
<b>ETC1029G</b>	2	●
<b>ETC10294MB</b>	4	○
<b>ETC10294MG</b>	4	●

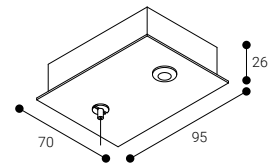

<b>ETC10295PB</b>	2	○
<b>ETC10295PG</b>	2	●
<b>ETC10295P4MB</b>	4	○
<b>ETC10295P4MG</b>	4	●

L corner accessory

	COLOUR
<b>TZ70M006B</b>	○
<b>TZ70M006G</b>	●

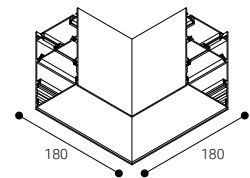

Joining accessory

	COLOUR
<b>TZ70M014</b>	●

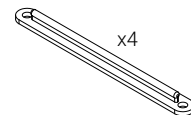

End cover

	COLOUR
<b>TZ70M016B</b>	○
<b>TZ70M016G</b>	●

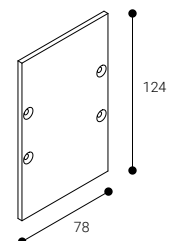



# Cosmos

COSMOS is a mixed structural system for spot and linear lighting. It is made of an extruded and lacquered aluminium profile housing.

## Two versions

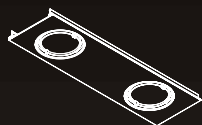

Module configured as  
PROJECTOR

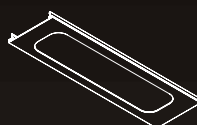

Module configured as  
LINEAR LIGHT

Suspended ceiling mounted

Surface ceiling mounted

Ceiling recessed mounted



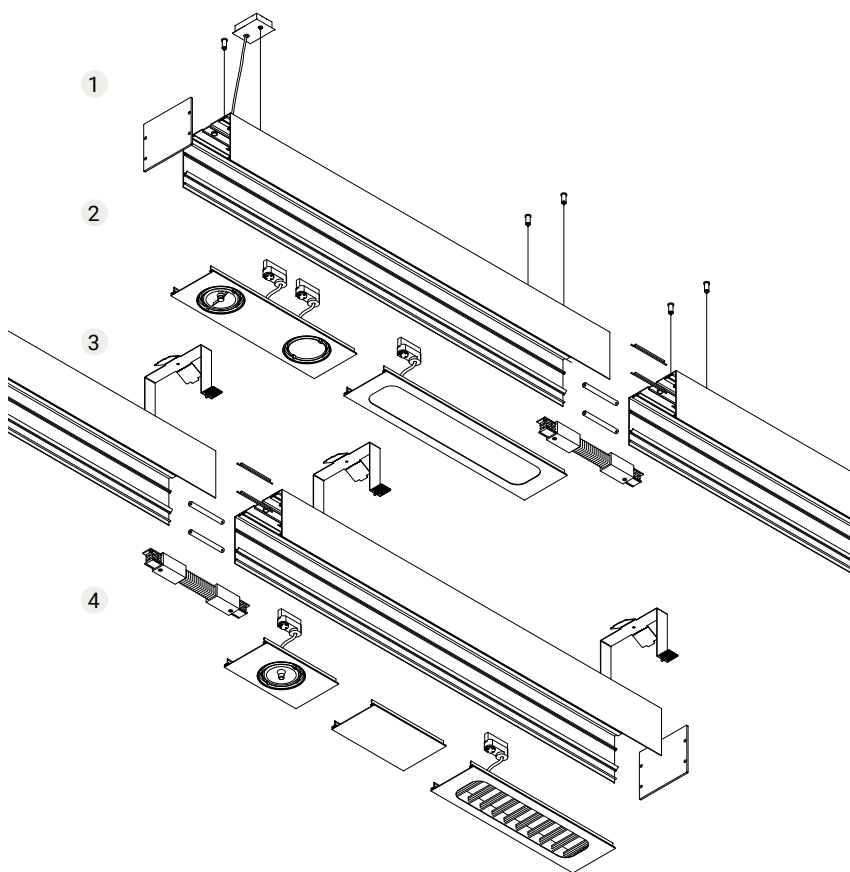

- 1 END CAPS  
Sold separately, they include the terminals of electrified rail. In the recessed version, both caps come with ventilation holes.
- 2 EXTERNAL PROFILE  
For all the possible configurations and available from 900mm up to 2400mm. Incorporates an electrified rail that guarantees the electrical continuity in all the pieces and with just one power connection.
- 3 INSTALLATION  
Three options available: Suspended, surface mounted or ceiling recessed mounted. Once selected, all the necessary installation accessories will be assigned.
- 4 MODULES  
Can be configured as projectors or linear light, installed with clips that guarantee and simplify the mounting process. Electrical connection is made by means of a standard adapter.

### Cosmos projector

### Cosmos linear light

Installation	Surface ceiling mounted Suspended ceiling mounted Ceiling recessed mounted	Surface ceiling mounted Suspended ceiling mounted Ceiling recessed mounted
Diffuser	☉	⊙
Light source	LED	LED
Photobiological safety	1	0
UGR	19	22
CRI	>80	>80
MacAdam ellipse	3	3
Beam angle range	95	105
Power range (W)	11,8	26,8-53,6
Colour temperature (°K)	3000   4000	3000   4000
Light range	1930-4100	3040-6720
Power factor	0,95	0,95
Efficiency (%)	93,2	75
Expectancy	60000 h L70B10	60000 h L70B10
DALI Option	–	–
Continuous operation 24h	✓	✓
IP	20	20
Class	I	I
Energy efficiency	A   B	D   E

☉ Opal diffuser    ⊙ Transparent diffuser



RAL9016



RAL9005

# Cosmos

Suspended ceiling mounted    Surface ceiling mounted    Ceiling recessed mounted



60000 h.  
L70B10

CRI  
>80

95°

Efficiency (%)  
93,2

Photobiological safety

RG1\* **1** Low risk

\*Time under 3 h.

Go to page 443 to learn more

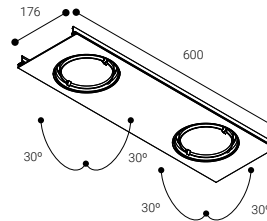
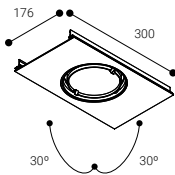

## Projector

### ☉ TRANSPARENT DIFFUSER

	K	REF.	W	LUMEN			REF. DALI
IP 20	3000	<b>CSP123FB</b>	11,8 W	1930 lm	○	1,2	—
UGR 19	4000	<b>CSP124FB</b>	11,8 W	2050 lm	○	1,2	—

	K	REF.	W	LUMEN			REF. DALI
IP 20	3000	<b>CSP223FB</b>	11,8 W	3860 lm	○	2,4	—
UGR 19	4000	<b>CSP224FB</b>	11,8 W	4100 lm	○	2,4	—

○ RAL9016

● RAL9005 Replace "B" by "N" in the reference

DALI REGULATION AVAILABLE

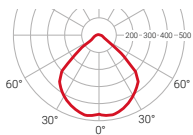

— CO-C180  
— C90-C270     $\eta=93\%$



# Cosmos

Suspended ceiling mounted    Surface ceiling mounted    Ceiling recessed mounted

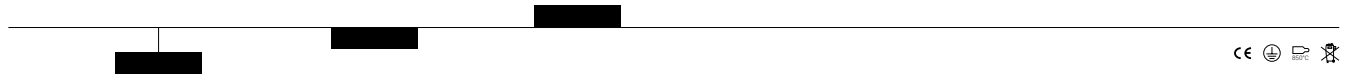

60000 h.  
L70B10

CRI  
>80

105°

Efficiency (%)  
75

Photobiological safety

RG0 **0** Risk free

\*Time under 3 h.

Go to page 443 to learn more

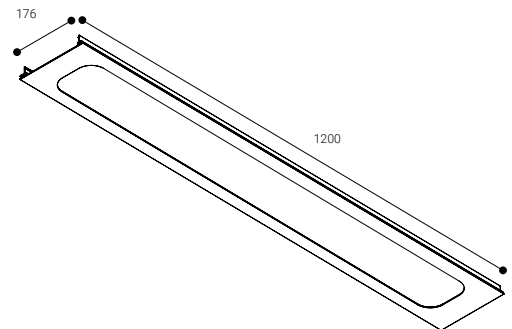
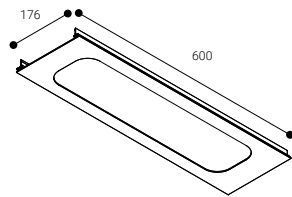

## Linear light

### OPAL DIFFUSER

	K	REF.	W	LUMEN			REF. DALI
IP 20	3000	<b>CSS230B</b>	26,8 W	3040 lm	○	2,4	—
UGR 22	4000	<b>CSS240B</b>	26,8 W	3360 lm	○	2,4	—

	K	REF.	W	LUMEN			REF. DALI
IP 20	3000	<b>CSS430B</b>	53,6 W	6080 lm	○	3,2	—
UGR 22	4000	<b>CSS440B</b>	53,6 W	6720 lm	○	3,2	—

○ RAL9016

● RAL9005 Replace "B" by "N" in the reference

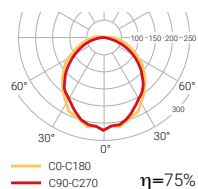

# Cosmos

Suspended ceiling mounted

Surface ceiling mounted

Ceiling recessed mounted

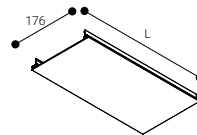
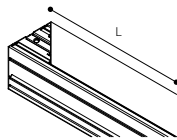
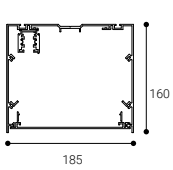

## Structural elements

### EXTERNAL PROFILE

REF.	L (mm)	
CS3P0300B	300	<input type="radio"/>
CS3P0600B	600	<input type="radio"/>
CS3P0900B	900	<input type="radio"/>
CS3P01200B	1200	<input type="radio"/>
CS3P01500B	1500	<input type="radio"/>
CS3P01800B	1800	<input type="radio"/>
CS3P02100B	2100	<input type="radio"/>
CS3P02400B	2400	<input type="radio"/>

- RAL9016
- RAL9005 Replace "B" by "N" in the reference

### BLANK MODULES

REF.	L (mm)	
CS3T0300B	300	<input type="radio"/>
CS3T0600B	600	<input type="radio"/>
CS3T0900B	900	<input type="radio"/>
CS3T01200B	1200	<input type="radio"/>
CS3T01500B	1500	<input type="radio"/>

- RAL9016
- RAL9005 Replace "B" by "N" in the reference

# Cosmos

ACCESSORIES

Joining accessory

	COLOUR	
<b>CS014B</b>	○	
<b>CS014N</b>	●	

Cover

	COLOUR	
<b>CS016FB</b>	○	end cap
<b>CS016FN</b>	●	end cap
<b>CS016FEB</b>	○	end recessed
<b>CS016FEN</b>	●	end recessed
<b>CS016IB</b>	○	starting cap
<b>CS016IN</b>	●	starting cap
<b>CS016IEB</b>	○	recessed starting cap
<b>CS016IEN</b>	●	recessed starting cap

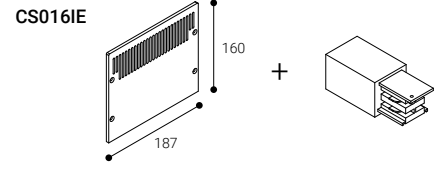
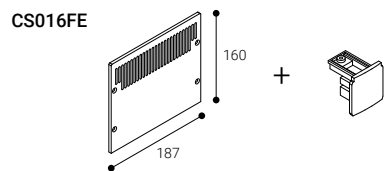
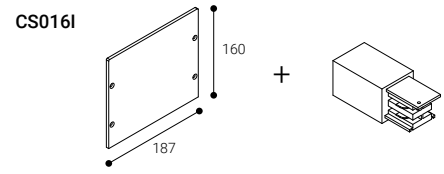
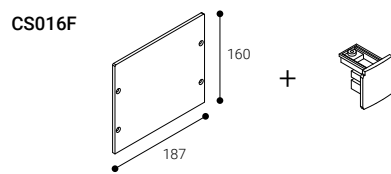

Recessed accessory

	L (mm)
<b>CS0312</b>	600 a 900
<b>CS0313</b>	1200 a 1500
<b>CS0314</b>	1800 a 2100

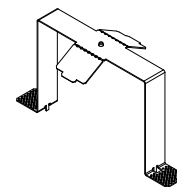

Suspension accessory

	L (m)	COLOUR
<b>CS1029L2</b>	2	
<b>CS1029L2AB</b>	2	○ with mains connection box
<b>CS1029L2AN</b>	2	● with mains connection box



Linear luminaires



# Sycom

SYCOM is a suspended lighting system that creates a distinctive geometry for each installation. The different modules can be combined in multiple ways.

Two versions

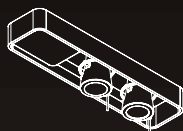

Module configured as  
PROJECTOR

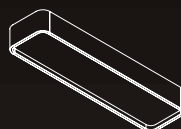

Module configured as  
LINEAR LIGHT

Suspended ceiling mounted





### Sycom projector

### Sycom linear light

Installation	Suspended ceiling mounted	Suspended ceiling mounted
Diffuser	⊙ ⊙	⊙
Light source	LED	LED
Photobiological safety	1	0
UGR	19   22	22
CRI	>80	>80
MacAdam ellipse	0	3
Beam angle range	32-88	106
Power range (W)	11,8	26,8-53,6
Colour temperature (°K)	3000   4000	3000   4000
Light range	3860-8860	3040-6720
Power factor	0,95	0,95
Efficiency (%)	87,9	63,4
Expectancy	60000 h L70B10	72000 h L70B10
DALI Option	—	—
Continuous operation 24h	✓	✓
IP	20	30
Class	II	I
Energy efficiency	A	D   E

⊙ Opal diffuser    ⊙ Transparent diffuser

# Sycom

Suspended ceiling mounted

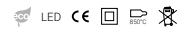

60000 h.  
L70B10

CRI  
>80

88°

Efficiency (%)  
87,9

Photobiological safety

RG1\* **1** Low risk

\*Time under 3h.

Go to page 443 to learn more

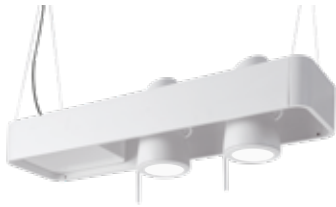

## Projector

© OPAL DIFFUSER

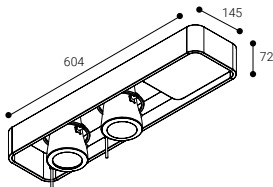

	K	REF.	W	LUMEN			REF. DALI
IP 20	3000	<b>SYP2230B</b>	11,8 W	3860 lm	○	3,4	—
UGR 22	4000	<b>SYP2240B</b>	11,8 W	4100 lm	○	3,4	—

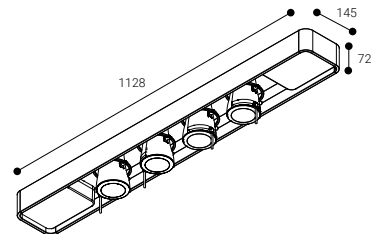

	K	REF.	W	LUMEN			REF. DALI
IP 20	3000	<b>SYP4230B</b>	11,8 W	7720 lm	○	6,8	—
UGR 22	4000	<b>SYP4240B</b>	11,8 W	8200 lm	○	6,8	—

○ RAL9016

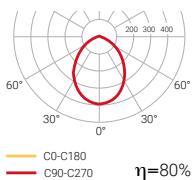

# Sycom

Suspended ceiling mounted



60000 h.  
L70B10

CRI  
>80

32°

Efficiency (%)  
87,9

Photobiological safety

RG1\* **1** Low risk

\*Time under 3 h.

Go to page 443 to learn more



## Projector

### © TRANSPARENT DIFFUSER

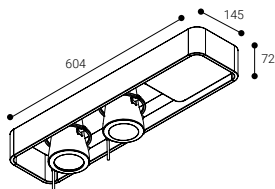

	K	REF.	W	LUMEN			REF. DALI
IP 20	3000	SYP223SB	11,8 W	3860 lm	○	3,4	—
UGR 19	4000	SYP224SB	11,8 W	4100 lm	○	3,4	—

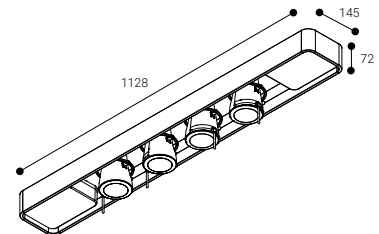

	K	REF.	W	LUMEN			REF. DALI
IP 20	3000	SYP423SB	11,8 W	8860 lm	○	6,8	—
UGR 19	4000	SYP424SB	11,8 W	8200 lm	○	6,8	—

### ○ RAL9016

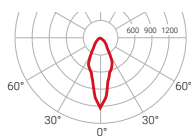

— C0-C180  
— C90-C270  $\eta=87\%$

# Sycom

Suspended ceiling mounted



LED CE ENEC RoHS

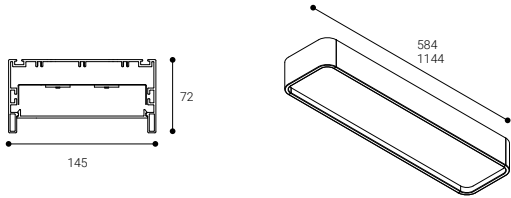

72000 h. L70B10 | CRI >80 | 106° | Efficiency (%) 63,4

Photobiological safety

RG0 0 Risk free

\*Time under 3 h.

Go to page 443 to learn more



## Linear light

### OPAL DIFFUSER

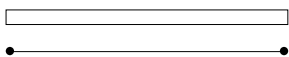

L = 584 mm

	K	REF.	W	LUMEN			REF. DALI
IP 30	3000	<b>SYS2L3B</b>	26,8 W	3040 lm	30°	3,9	<b>SYS2L3DB</b>
UGR 22	4000	<b>SYS2L4B</b>	26,8 W	3360 lm	30°	3,9	<b>SYS2L4DB</b>

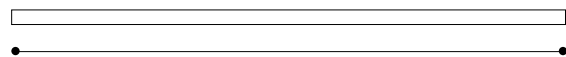

L = 1144 mm

	K	REF.	W	LUMEN			REF. DALI
IP 30	3000	<b>SYS4L3B</b>	53,6 W	6080 lm	30°	4,9	<b>SYS4L3DB</b>
UGR 22	4000	<b>SYS4L4B</b>	53,6 W	6720 lm	30°	4,9	<b>SYS4L4DB</b>

### RAL9016

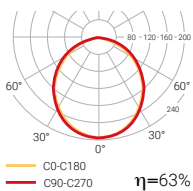



# Sycom

ACCESSORIES

Suspension accessory

	L (m)	COLOUR
<b>1029SYS</b>	2	○
<b>1029SYP</b>	2	○

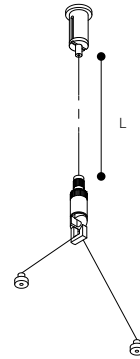

Connection box and power supply cable

	POWER SUPPLY CABLE LENGTH	COLOUR
<b>ETC1029B</b>	2	○
<b>ETC10294MB</b>	4	○

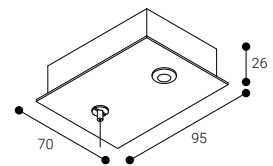

Joining accessory

	COLOUR
<b>SY014B</b>	○

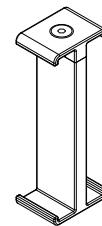

# Coral

CORAL is an LED lighting system based on an extruded and laquered aluminium profile. It might be displayed as suspended or a ceiling mounted fitting.

Ideal solution for linear luminaires of light.

---

●

 <b>72000 h.</b> L70B10	CRI <b>&gt;80</b>	 <b>105°</b>	Efficiency (%) <b>75</b>
---------------------------------------------------------------------------------------------------------------	----------------------	-------------------------------------------------------------------------------------------------	-----------------------------

Photobiological safety

**RG0**  **0** Risk free

[Go to page 443 to learn more](#)

Suspended ceiling mounted

Surface ceiling mounted

---

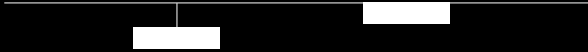



## Coral

Installation                      Suspended ceiling mounted  
                                                  Surface ceiling mounted

Diffuser	☉
Light source	LED
Photobiological safety	0
UGR	22
CRI	>80
MacAdam ellipse	3
Beam angle range	105
Power range (W)	26,8-53,6
Colour temperature (°K)	3000   4000
Light range	3040-6720
Power factor	0,95
Efficiency (%)	75
Expectancy	72000 h L70B10
DALI Option	—
Continuous operation 24h	✓
IP	30
Class	I
Energy efficiency	D   E

☉ Opal diffuser



RAL9016



RAL7001



For other CRI values,  
 please contact us.

# Coral

Suspended ceiling mounted

Surface ceiling mounted

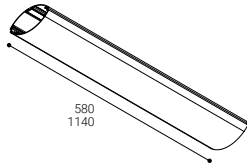
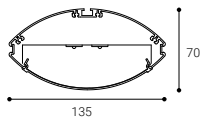

72000 h.  
L70B10

CRI  
>80

105°

Efficiency (%)  
75

Photobiological safety

RG0 **0** Risk free

\*Time under 3h.

Go to page 443 to learn more



## OPAL DIFFUSER

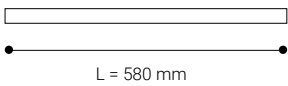

	K	REF.	W	LUMEN			REF. DALI
IP 30	3000	<b>C23LOB</b>	26,8 W	3040 lm	○	1,8	—
UGR 22	4000	<b>C24LOB</b>	26,8 W	3360 lm	○	1,8	—

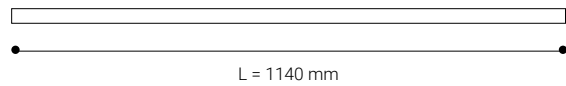

	K	REF.	W	LUMEN			REF. DALI
IP 30	3000	<b>C43LOB</b>	53,6 W	6080 lm	○	3,5	—
UGR 22	4000	<b>C44LOB</b>	53,6 W	6720 lm	○	3,5	—

- RAL9016
- RAL7001 Replace "B" by "G" in the reference

DALI REGULATION AVAILABLE

UNION ACCESSORIES INCLUDED

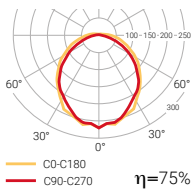

# Coral

ACCESSORIES

Suspension accessory

	L (m)	COLOUR
<b>1027B</b>	4	○
<b>1027G</b>	4	●
<b>1028B</b>	2	○
<b>1028G</b>	2	●
<b>1029L2</b>	2	○
<b>1029L4</b>	4	○

1027 / 1028

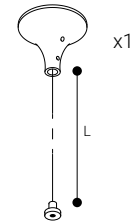

1029

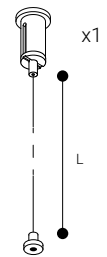

End cover

	COLOUR
<b>C015B</b>	○
<b>C015G</b>	●
<b>C016B</b>	○
<b>C016G</b>	●

C015

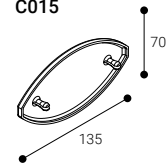

C016

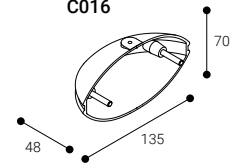

Elbow union accessory

	COLOUR
<b>C006B</b>	○
<b>C006G</b>	●

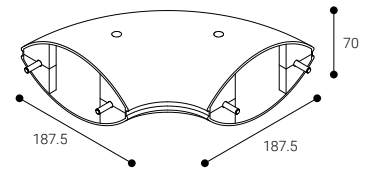





# Zafiro

ZAFIRO is a small-sized spatial system.  
Specially designed for LED light sources,  
made of aluminium profile.

---

●

 <b>72000 h.</b> L70B10	CRI <b>&gt;80</b>	 <b>100°</b>	Efficiency (%) <b>54,2</b>
---------------------------------------------------------------------------------------------------------------	----------------------	-------------------------------------------------------------------------------------------------	-------------------------------

Photobiological safety

**RG0**  **0** Risk free

[Go to page 443 to learn more](#)

Suspended ceiling mounted

Surface ceiling mounted

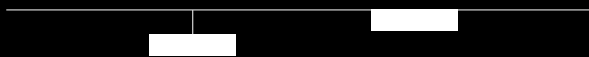



## Zafiro

Installation                      Suspended ceiling mounted  
                                                  Surface ceiling mounted

Diffuser                              ©

Light source                        LED

Photobiological safety            0

UGR                                    22

CRI                                    >80

MacAdam ellipse                 3

Beam angle range                100

Power range (W)                 26,8-57

Colour temperature (°K)        3000 | 4000

Light range                        3040-7740

Power factor                        0,95

Efficiency (%)                      54,2

Expectancy                        72000 h L70B10

DALI Option                        –

Continuous operation 24h      ✓

IP                                      30

Class                                 I

Energy efficiency                 D | E

© Opal diffuser

**CRI 360** | For other CRI values,  
 please contact us.



RAL9016



RAL7001

# Zafiro

Suspended ceiling mounted

Surface ceiling mounted

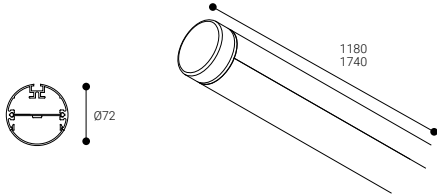

72000 h.  
L70B10

CRI  
>80

100°

Efficiency (%)  
54,2

Photobiological safety

RG0 **0** Risk free

\*Time under 3 h.

Go to page 443 to learn more

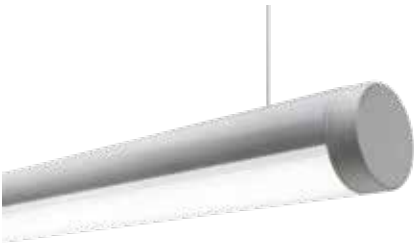

## OPAL DIFFUSER

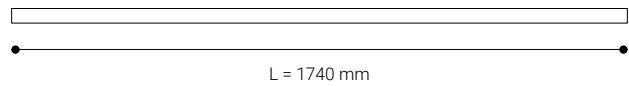
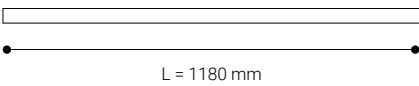

	K	REF.	W	LUMEN			REF. DALI
IP 30	3000	Z4L3OB	26,8 W	3040 lm	○	2,0	—
		Z4H3OB	38 W	4640 lm	○	2,0	—
UGR 22	4000	Z4L4OB	26,8 W	3360 lm	○	2,0	—
		Z4H4OB	38 W	5160 lm	○	2,0	—

	K	REF.	W	LUMEN			REF. DALI
IP 30	3000	Z6L3OB	40,2 W	4560 lm	○	2,9	—
		Z6H3OB	57 W	6960 lm	○	2,9	—
UGR 22	4000	Z6L4OB	40,2 W	5040 lm	○	2,9	—
		Z6H4OB	57 W	7740 lm	○	2,9	—

- RAL9016
- RAL7001 Replace "B" by "G" in the reference

DALI REGULATION AVAILABLE

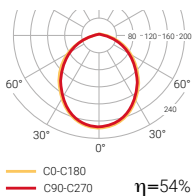



# Zafiro

ACCESSORIES

Suspension accessory

	L (m)	COLOUR
<b>1029L2</b>	2	●
<b>1029L4</b>	4	●

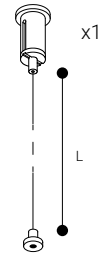



---

# LED strips

We offer a complete professional solution in decorative lighting using LED strips.

High brightness 24V monochromatic or RGBW LED strips for indoors (IP20) or outdoors use (IP67) and perfect to illuminate and decorate any domestic, commercial or professional atmosphere.

Wide range of profiles, perfectly adapted to the needs of any project.

Normalit supplies a solution which is fully customized and ready to install: LED strip + Profile + Cover + Accessories. Check the supply conditions.

 Please ask us about our cut and assembly service

# LED strips

## Profiles

We offer different types of profile solutions for different types of executions: recessed, surface mounted and corner mounted. We also offer profiles in different heights, and wider housings for IP67 strips.

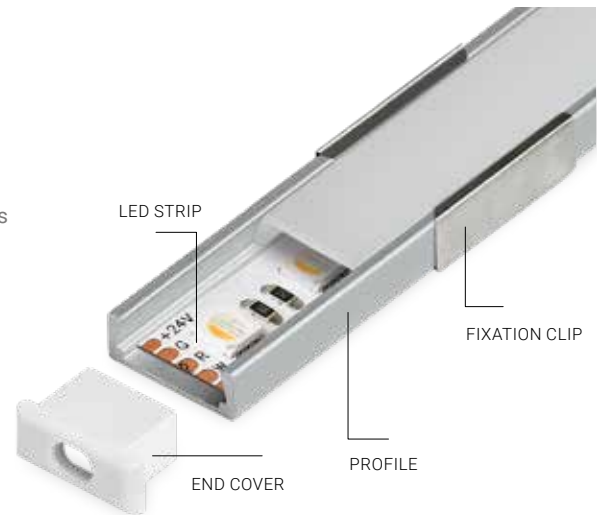

## RECESSED MOUNTED PROFILES

### LOW HEIGHT RECESSED PROFILE



LENGTH		COMPATIBILITY STRIP	
<b>TLP1A</b>	1 m	IP 20	Monochromatic
<b>TLP2A</b>	2 m		

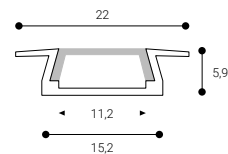

#### DiffuserES

##### OPAL

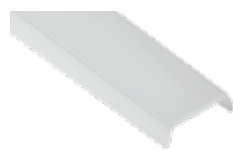

LENGTH

<b>TL01AB</b>	1 m
<b>TL02AB</b>	2 m

##### TRANSPARENT



LENGTH

<b>TLT1AB</b>	1 m
<b>TLT2AB</b>	2 m

#### ACCESSORIES

##### END COVERS

##### TLPAT



##### FIXATION CLIPS

##### TLPABS

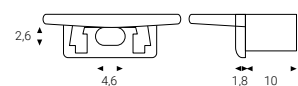

# LED strips

## RECESSED MOUNTED PROFILES

### STANDARD RECESSED MOUNTED



	LENGTH
<b>TLP1C</b>	1 m
<b>TLP2C</b>	2 m

#### COMPATIBILITY STRIP

IP 20 Monochromatic	IP 67 
IP 20 RGBW	Monochromatic

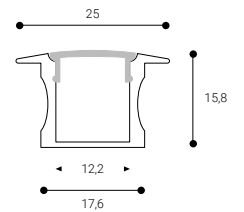

#### COVERS

##### OPAL



##### TRANSPARENT

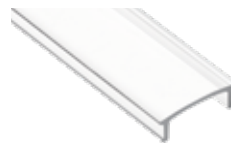

	LENGTH
<b>TL01CD</b>	1 m
<b>TL02CD</b>	2 m

	LENGTH
<b>TLT1CD</b>	1 m
<b>TLT2CD</b>	2 m

#### ACCESSORIES

##### END COVERS

##### TLPCT



##### FIXATION CLIPS

##### TLPDCS

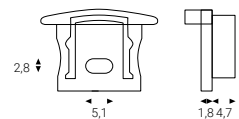



### WIDE RECESSED MOUNTED



	LENGTH
<b>TLP1F</b>	1 m
<b>TLP2F</b>	2 m

#### COMPATIBILITY STRIP

IP 20 Monochromatic	IP 67 	Monochromatic
IP 20 RGBW	IP 67 	RGBW

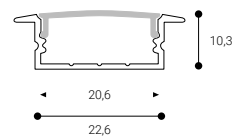

#### COVERS

##### OPAL

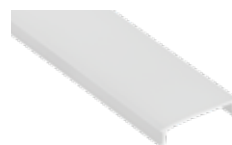

##### TRANSPARENT



	LENGTH
<b>TL01FG</b>	1 m
<b>TL02FG</b>	2 m

	LENGTH
<b>TLT1FG</b>	1 m
<b>TLT2FG</b>	2 m

#### ACCESSORIES

##### END COVERS

##### TLPFT



##### FIXATION CLIPS

##### TLPFGS

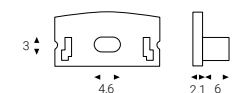

# LED strips

## SURFACE MOUNTED PROFILES

### SURFACE MOUNTED LOW HEIGHT



	LENGTH
<b>TLP1B</b>	1 m
<b>TLP2B</b>	2 m

COMPATIBILITY STRIP  
 IP 20 Monochromatic

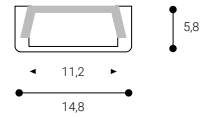

#### COVERS

OPAL



TRANSPARENT



	LENGTH
<b>TL01AB</b>	1 m
<b>TL02AB</b>	2 m

	LENGTH
<b>TLT1AB</b>	1 m
<b>TLT2AB</b>	2 m

#### ACCESSORIES

END COVERS

**TLPBT**



FIXATION CLIPS

**TLPABS**

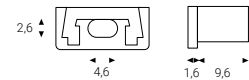

### STANDARD SURFACE MOUNTED



	LENGTH
<b>TLP1D</b>	1 m
<b>TLP2D</b>	2 m

COMPATIBILITY STRIP  
 IP 20 Monochromatic IP 67  
 IP 20 RGBW Monochromatic

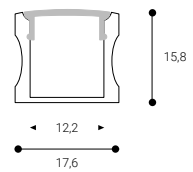

#### COVERS

OPAL



TRANSPARENT

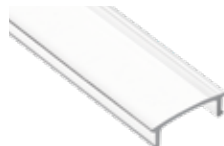

	LENGTH
<b>TL01CD</b>	1 m
<b>TL02CD</b>	2 m

	LENGTH
<b>TLT1CD</b>	1 m
<b>TLT2CD</b>	2 m

#### ACCESSORIES

END COVERS

**TLPDT**



FIXATION CLIPS

**TLPDCDS**

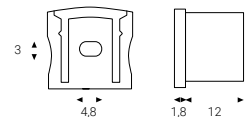

# LED strips

## SURFACE MOUNTED PROFILES

### WIDE SURFACE MOUNTED



	LENGTH
<b>TLP1G</b>	1 m
<b>TLP2G</b>	2 m

#### COMPATIBILITY STRIP

IP 20	Monochromatic	IP 67	Monochromatic
IP 20	RGBW	IP 67	RGBW

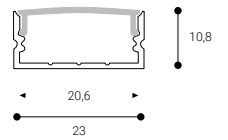

#### COVERS

##### OPAL

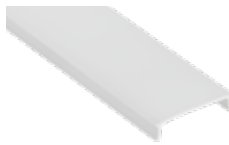

##### TRANSPARENT

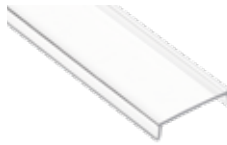

	LENGTH
<b>TL01FG</b>	1 m
<b>TL02FG</b>	2 m

	LENGTH
<b>TLT1FG</b>	1 m
<b>TLT2FG</b>	2 m

#### ACCESSORIES

##### END COVERS

##### TLPGT



##### FIXATION CLIPS

##### TLPFGS

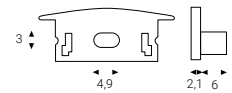

# LED strips

## PROFILES FOR CORNERS

### STANDARD CORNER



	LENGTH
<b>TLP1E</b>	1 m
<b>TLP2E</b>	2 m

COMPATIBILITY STRIP	
IP 20 Monochromatic	IP 67 Monochromatic
IP 20 RGBW	IP 67 RGBW

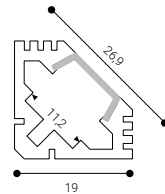

#### COVERS

##### OPAL



	LENGTH
<b>TLO1AB</b>	1 m
<b>TLO2AB</b>	2 m

##### TRANSPARENT

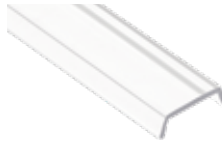

	LENGTH
<b>TLT1AB</b>	1 m
<b>TLT2AB</b>	2 m

#### ACCESSORIES

##### END COVERS

##### TLPET



##### FIXATION CLIPS

##### TLPES

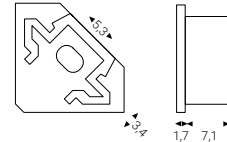

### WIDE CORNER PROFILE



	LENGTH
<b>TLP1H</b>	1 m
<b>TLP2H</b>	2 m

COMPATIBILITY STRIP	
IP 20 Monochromatic	IP 67 Monochromatic
IP 20 RGBW	IP 67 RGBW

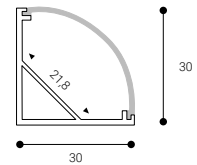

#### COVERS

##### OPAL



	LENGTH
<b>TLO1H</b>	1 m
<b>TLO2H</b>	2 m

##### TRANSPARENT



	LENGTH
<b>TLT1H</b>	1 m
<b>TLT2H</b>	2 m

#### ACCESSORIES

##### END COVERS

##### TLPHT



##### FIXATION CLIPS

##### TLPHS

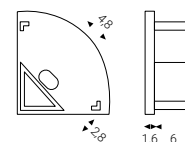





# LED strips

## LED strips IP20

**!** SUPPLIED IN 30 METERS REELS.  
PLEASE ASK FOR OTHER MEASUREMENTS.

### IP20 MONOCHROMATIC

LED CE IP 20 CRI 90 24 V

Monochromatic LED strips (IP20) for indoors with adhesive tape included. Available in four different powers (4.8 w / 9.6 w / 14.4 w / 19.2 w) and four colour temperatures (2700K / 3000K / 4000K / 5000K).

**4,8** W/m 60 Leds/m Expectancy **50000 h.** L70B10



	Lm/m	K	WIDTH	→ ✂ ←
TL0427I	387 lm	2700	8,5 mm	100 mm
TL0430I	399 lm	3000	8,5 mm	100 mm
TL0440I	420 lm	4000	8,5 mm	100 mm
TL0450I	442 lm	5000	8,5 mm	100 mm

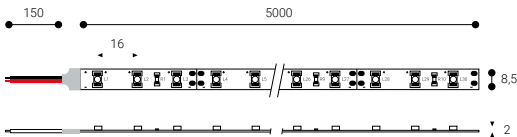

**9,6** W/m 120 Leds/m Expectancy **50000 h.** L70B10

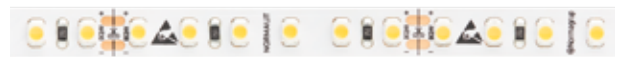

	Lm/m	K	WIDTH	→ ✂ ←
TL0827I	774 lm	2700	8,5 mm	50 mm
TL0830I	798 lm	3000	8,5 mm	50 mm
TL0840I	840 lm	4000	8,5 mm	50 mm
TL0850I	884 lm	5000	8,5 mm	50 mm

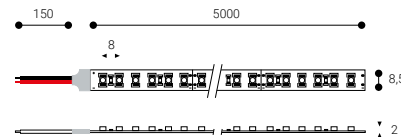

**14,4** W/m 180 Leds/m Expectancy **50000 h.** L70B10



	Lm/m	K	WIDTH	→ ✂ ←
TL1227I	1106 lm	2700	10 mm	34 mm
TL1230I	1140 lm	3000	10 mm	34 mm
TL1240I	1200 lm	4000	10 mm	34 mm
TL1250I	1263 lm	5000	10 mm	34 mm

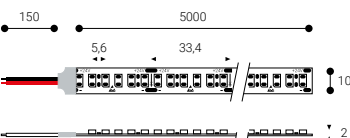

**19,2** W/m 240 Leds/m Expectancy **50000 h.** L70B10



	Lm/m	K	WIDTH	→ ✂ ←
TL1727I	1567 lm	2700	10 mm	25 mm
TL1730I	1615 lm	3000	10 mm	25 mm
TL1740I	1700 lm	4000	10 mm	25 mm
TL1750I	1789 lm	5000	10 mm	25 mm

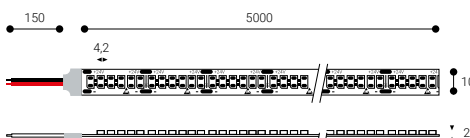

# LED strips

## LED strips IP20

**!** SUPPLIED IN 30 METERS REELS.  
PLEASE ASK FOR OTHER MEASUREMENTS.

### IP20 RGBW

LED CE IP 20 24 V

RGBW Led strips (IP20) for indoors with adhesive tape included. Unlike the monochromatic LED strip, the RGBW LED strip makes it possible to create customized atmospheres thanks to the light control through the mixture of red, green and blue colours. Furthermore, it is possible to play with different white tones (from warm white to cold white). Available in two different powers (19.2 w / 23 w.)

**19,2 W/m** 60 Leds/m Expectancy **50000 h.** L70B10



Lm/m WIDTH ←↯→

**TL07RGI** R: 120 G: 300 B:110 W: 400 12 mm 84 mm

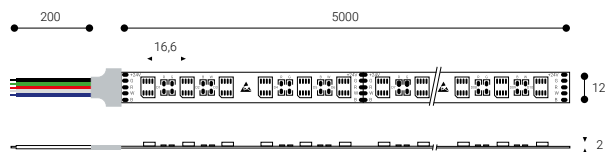

**23 W/m** 72 Leds/m Expectancy **50000 h.** L70B10



Lm/m WIDTH ←↯→

**TL14RGI** R: 150 G: 375 B:138 W: 500 12 mm 84 mm

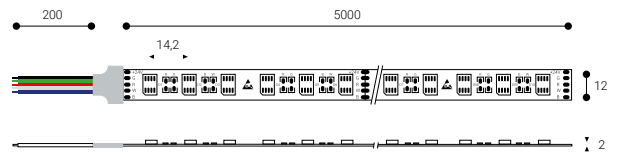

# LED strips

## LED strips IP67

**!** SUPPLIED IN 10 METERS REELS.  
PLEASE ASK FOR OTHER MEASUREMENTS.

### IP67 MONOCHROMATIC

LED CE IP 67 CRI 90 24 V

Monochromatic LED strips (IP67) for outdoors with adhesive tape included. Available in four different powers (4.8 w / 9.6 w / 14.4 w / 19.2 w) and four colour temperatures (2700K / 3000K / 4000K / 5000K).

**4,8 W/m** 60 Leds/m Expectancy **50000 h.** L70B10



	Lm/m	K	WIDTH	↔ ✂ ↔
<b>TL04270</b>	387 lm	2700	10,7 mm	100 mm
<b>TL04300</b>	399 lm	3000	10,7 mm	100 mm
<b>TL04400</b>	420 lm	4000	10,7 mm	100 mm
<b>TL04500</b>	442 lm	5000	10,7 mm	100 mm

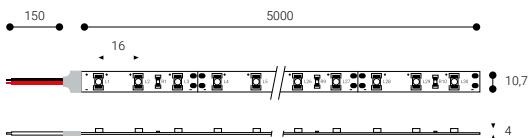

**9,6 W/m** 120 Leds/m Expectancy **50000 h.** L70B10



	Lm/m	K	WIDTH	↔ ✂ ↔
<b>TL08270</b>	774 lm	2700	10,7 mm	50 mm
<b>TL08300</b>	798 lm	3000	10,7 mm	50 mm
<b>TL08400</b>	840 lm	4000	10,7 mm	50 mm
<b>TL08500</b>	884 lm	5000	10,7 mm	50 mm

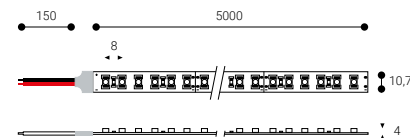

**14,4 W/m** 60 Leds/m Expectancy **50000 h.** L70B10



	Lm/m	K	WIDTH	↔ ✂ ↔
<b>TL12270</b>	1106 lm	2700	12,5 mm	100 mm
<b>TL12300</b>	1140 lm	3000	12,5 mm	100 mm
<b>TL12400</b>	1200 lm	4000	12,5 mm	100 mm
<b>TL12500</b>	1263 lm	5000	12,5 mm	100 mm

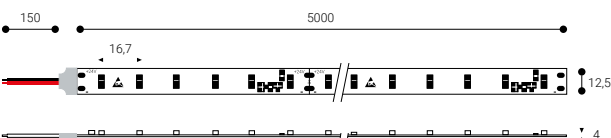

**19,2 W/m** 120 Leds/m Expectancy **50000 h.** L70B10



	Lm/m	K	WIDTH	↔ ✂ ↔
<b>TL17270</b>	1567 lm	2700	12,5 mm	50 mm
<b>TL17300</b>	1615 lm	3000	12,5 mm	50 mm
<b>TL17400</b>	1700 lm	4000	12,5 mm	50 mm
<b>TL17500</b>	1789 lm	5000	12,5 mm	50 mm

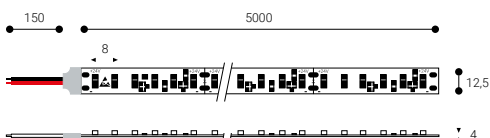

# LED strips

## LED strips IP67

**!** SUPPLIED IN 10 METERS REELS.  
PLEASE ASK FOR OTHER MEASUREMENTS.

### IP67 RGBW



RGBW LED strips (IP67) with adhesive tape included.  
Unlike the monochromatic LED strips, RGBW LED strip makes it possible to create different customized environments thanks to controlling the colour by mixing red, green and blue. It is also possible to experiment with the different types of white light (from warm white to cold white).  
Available in two powers (19.2 w / 23 w).

**19,2** W/m 60 Leds/m Expectancy **50000 h.** L70B10



Lm/m WIDTH  $\rightarrow$   $\leftarrow$

**TL07RGO** R: 120 G: 300 B:110 W: 400 14 mm 100 mm

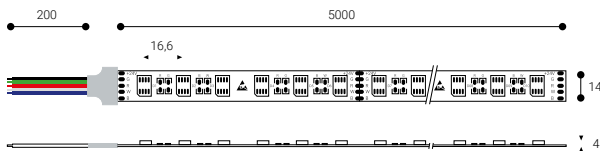

**23** W/m 72 Leds/m Expectancy **50000 h.** L70B10



Lm/m WIDTH  $\rightarrow$   $\leftarrow$

**TL14RGO** R: 150 G: 375 B:138 W: 500 14 mm 100 mm

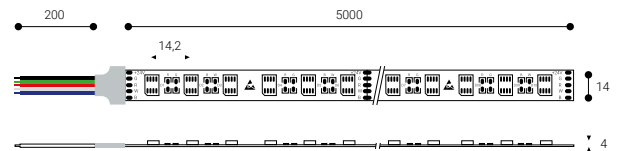

#### ACCESSORIES

##### DESCRIPTION

- TLIP13** Accessory bag for the handling of IP67 led strips 10,7 mm. wide. It includes terminal, connector and end covers, and joints fixation.
- TLIP15** Accessory bag for the handling of IP67 led strips 12,5 mm. wide. It includes terminal, connector and end covers, and joints fixation.
- TLIP17** Accessory bag for the handling of IP67 led strips 14 mm. wide. It includes terminal, connector and end covers, and joints fixation.

# LED strips

## Drivers

### For led strip

#### Standard

IP 20		IP 67 		DIMENSIONS			
	W		W	X	Y	Z	
<b>BE03024</b>	30	<b>BE030240</b>	30	<b>BE03024</b>	153	41,4	32
<b>BE06024</b>	60	<b>BE075240</b>	75	<b>BE06024</b>	180	52	30
<b>BE07524</b>	75	<b>BE100240</b>	100	<b>BE07524</b>	180	52	30
<b>BE12024</b>	120	<b>BE150240</b>	150	<b>BE12024</b>	300	40	30
<b>BE18024</b>	180	<b>BE200240</b>	200	<b>BE18024</b>	345	50	35
<b>BEU35024</b>	350	<b>BEU300240</b>	300	<b>BEU35024</b>	220	62	31
				<b>BE030240</b>	131	42	34
				<b>BE075240</b>	155	49	32
				<b>BE100240</b>	206	68,6	37
				<b>BE150240</b>	206	68,6	37
				<b>BE200240</b>	206	68,6	37
				<b>BEU300240</b>	246	77	39,5

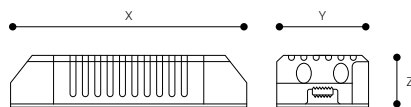

DALI 

Compatible with  
**NormaLINK** 

IP 20		DIMENSIONS			
	W	X	Y	Z	
<b>BE03524D</b>	35	<b>BE03524D</b>	195	43	30,2
<b>BE06024D</b>	60	<b>BE06024D</b>	225	43	30,2
<b>BE10024D</b>	100	<b>BE10024D</b>	295	43	29,8
<b>BE15024D</b>	150	<b>BE15024D</b>	325	43	30,2

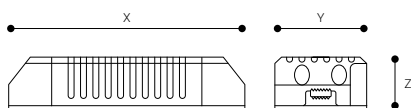

# LED strips

## Controllers

### REMOTE CONTROL



#### TRARF (RGBW)

Set of remote control and controller for RGBW led strip.

- Controls up to 8 zones
- Colour ring selector
- 9 predefined programs
- Radiofrequency transmission: 2.4 Ghz
- Maximum range: 30 meters
- Remote control dimensions: 18 x 55 x 130 mm
- Power: 3w (Two AAA batteries)
- Made in PC
- Controller dimensions: 23,5 x 48 x 89 mm
- Power: 24v DC
- Maximum power: 360w
- Maximum power per channel: 144W

#### TRARF-M

Remote control for TRARF-C controller.

#### TRARF-C

Controller for RGBW led strip.

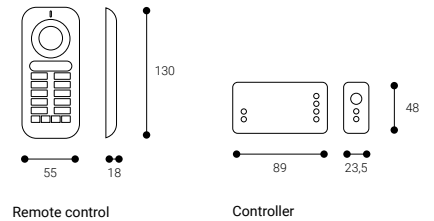

### Remote control wiring

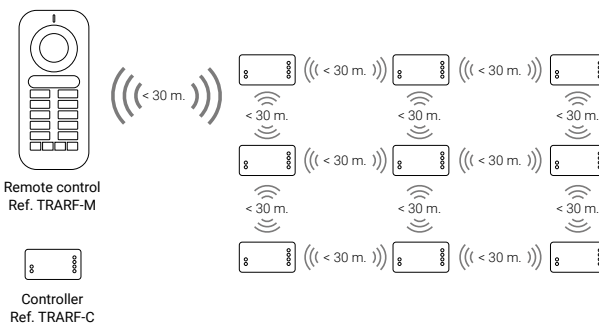
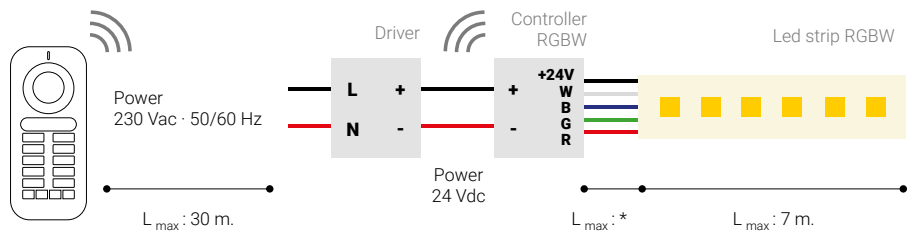

Each controller is able to reproduce the signal to other controllers that are 30 meters or less away from it.

\*Maximum length of 2 metres for a wire with length section below 0.5 sq.mm. For more than 2 metres, use a wire of 1.5 sq.mm. section.

# LED strips

## Amplifiers

### TRAMP (Monochromatic and RGBW)

**Amplifier for 24v RGBW led strip.**

- Output power: 768W.
- Dimensions: 147x70x34 mm.
- Power: 24 Vcc

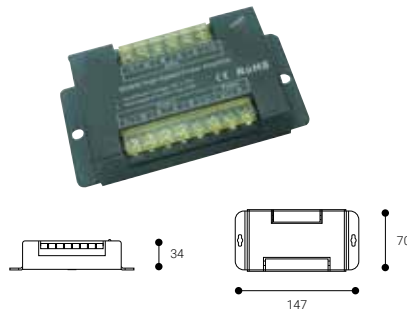

### TLRA

**Signal amplifier for monochromatic led strip 12-24 Vcc**

- Output power: 192 W.
- Dimensions: 45x45x12 mm.
- Power: 24 Vcc

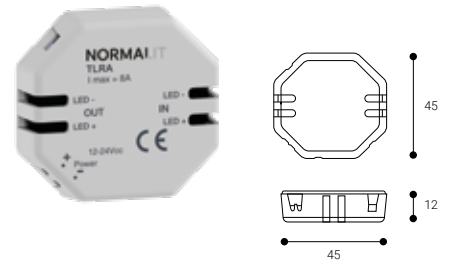

## Regulators

### TLRD

**Regulator for monochromatic led strip 12-48 Vcc with rotating remote control.**

- Output power: 192 W.
- Dimensions: 90x17,5x60 mm. (one DIN rail module)
- Power: 24 Vcc

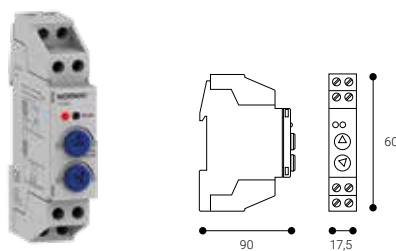

### TLRP

**Regulator for monochromatic LED strips 12-48 Vcc**

- Output power: 192 W.
- Dimensions: 46x46x24 mm.
- Power: 24 Vcc

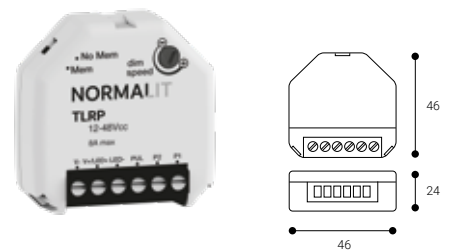



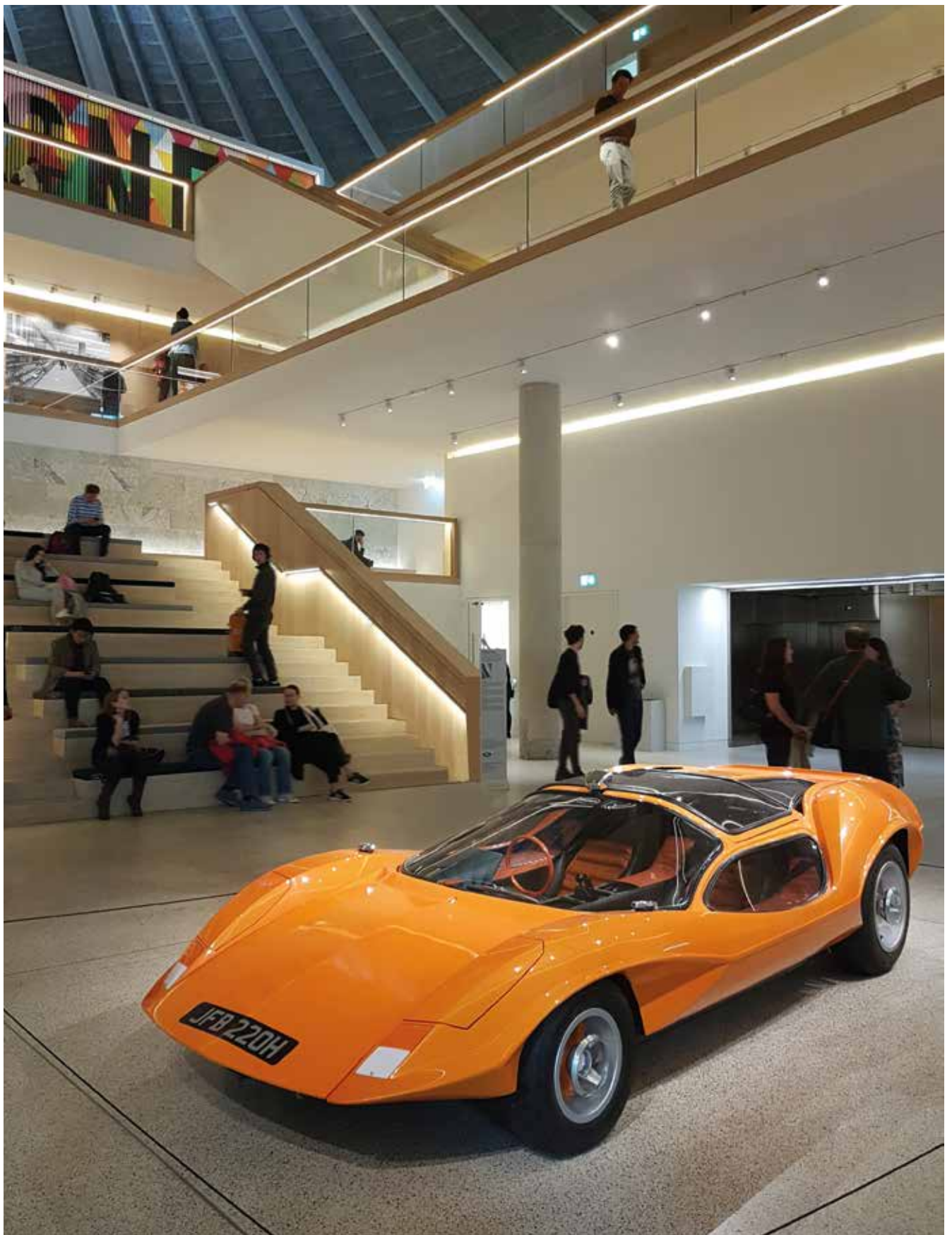

# Projectors





Silk  
364 | N



Aqa  
372



Dot  
378



Area  
384



Prolit  
394



Avalon  
398 | N



Nora  
406

# Silk



SILK is the new range of indoor projectors for installation on a track. A minimalist architectural lighting solution designed for a universal use thanks to its flexibility of integration into any space

## Optics

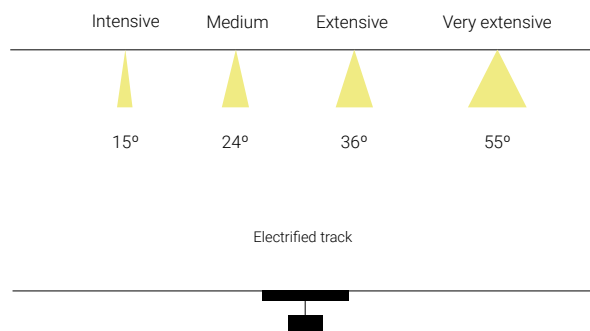





## Silk

Installation	Electrified track
Diffuser	☉
Light source	LED
Photobiological safety	1
UGR	22
CRI	>90
MacAdam ellipse	3
Beam angle range	15-55
Power range (W)	22-29,6
Colour temperature (°K)	2700   3000   4000
Light range	2340-3410
Power factor	0,95
Efficiency (%)	87
Expectancy	60000 h L80B10
DALI Option	✓
Continuous operation 24h	✓
IP	20
Class	II
Energy efficiency	D   E

☉ Without diffuser



For other CRI values, please contact us.

## A perfect approach

The reflective aluminum reflector of SILK projectors allows a more uniform distribution of light in indoor spaces, guaranteeing a perfect effect using any of the opening optics.

 INTERCHANGEABLE REFLECTORS ON REQUEST



RAL9016

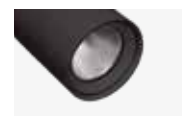

RAL9005



### More durable and sustainable

The die-cast aluminium body optimizes heat dissipation, extending the useful life of the projectors up to 60,000 hours.



# Silk

Electrified track

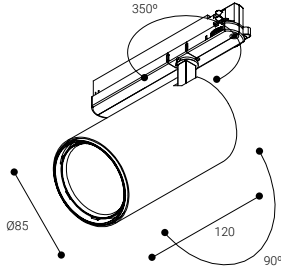
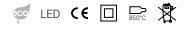

<b>60000 h.</b> L80B10	CRI <b>&gt;90</b>	<b>15-55°</b>	Efficiency (%) <b>87</b>
---------------------------	----------------------	---------------	-----------------------------

Photobiological safety

**RG1\*** **1** Low risk

\*Time under 3 h.

Go to page 443 to learn more



## INTESIVE OPTICS



15°

	K	REF.	W	LUMEN			REF. DALI
IP 20	2700	<b>PIM22SB</b>	22 W	2340 lm		0,7	<b>PIM22DSB</b>
UGR 22	3000	<b>PIM23SB</b>	22 W	2520 lm		0,7	<b>PIM23DSB</b>
	4000	<b>PIM24SB</b>	22 W	2715 lm		0,7	<b>PIM24DSB</b>

RAL9016

RAL9005 Replace "B" by "N" in the reference

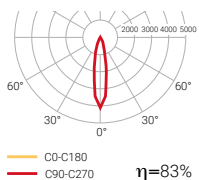

## MEDIUM OPTICS

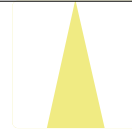

24°

	K	REF.	W	LUMEN			REF. DALI
IP 20	2700	<b>PIM22MB</b>	22 W	2340 lm		0,7	<b>PIM22DMB</b>
UGR 22	3000	<b>PIM23MB</b>	22 W	2520 lm		0,7	<b>PIM23DMB</b>
	4000	<b>PIM24MB</b>	22 W	2715 lm		0,7	<b>PIM24DMB</b>

RAL9016

RAL9005 Replace "B" by "N" in the reference

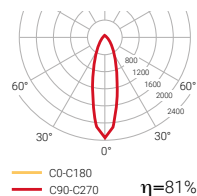



# Silk

Electrified track

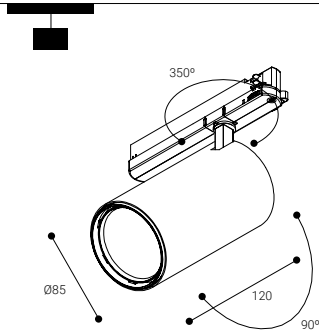

60000 h. L80B10 | CRI >90 |  $\Delta$  15-55° | Efficiency (%) 87

Photobiological safety

RG1\* **1** Low risk

\*Time under 3 h.

Go to page 443 to learn more

## EXTENSIVE OPTICS



36°

	K	REF.	W	LUMEN			REF. DALI
IP 20	2700	PIM22FB	22 W	2340 lm		0,7	PIM22DFB
UGR 22	3000	PIM23FB	22 W	2520 lm		0,7	PIM23DFB
	4000	PIM24FB	22 W	2715 lm		0,7	PIM24DFB

RAL9016

RAL9005 Replace "B" by "N" in the reference

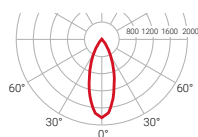

C0-C180  $\eta=82\%$   
 C90-C270



## VERY EXTENSIVE OPTICS

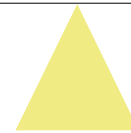

55°

	K	REF.	W	LUMEN			REF. DALI
IP 20	2700	PIM22WB	22 W	2340 lm		0,7	PIM22DWB
UGR 22	3000	PIM23WB	22 W	2520 lm		0,7	PIM23DWB
	4000	PIM24WB	22 W	2715 lm		0,7	PIM24DWB

RAL9016

RAL9005 Replace "B" by "N" in the reference

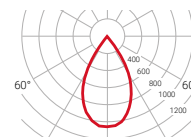

C0-C180  $\eta=83\%$   
 C90-C270



# Silk

Electrified track

LED CE RoHS

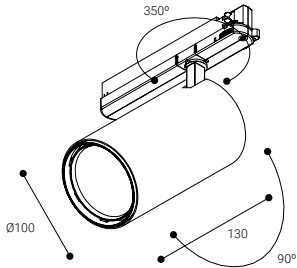

60000 h. L80B10 | CRI >90 | 15-55° | Efficiency (%) 87

Photobiological safety

RG1\* 1 Low risk

\*Time under 3 h.

Go to page 443 to learn more



## INTESIVE OPTICS



15°

	K	REF.	W	LUMEN	⊙	⚙	REF. DALI
IP 20	2700	PI32SB	29,6 W	2940 lm	⊙	0,8	PI32DSB
UGR 22	3000	PI33SB	29,6 W	3170 lm	⊙	0,8	PI33DSB
	4000	PI34SB	29,6 W	3410 lm	⊙	0,8	PI34DSB

⊙ RAL9016

● RAL9005 Replace "B" by "N" in the reference

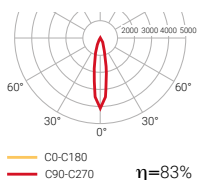

DALI Compatible with NormaLINK

## MEDIUM OPTICS

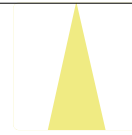

24°

	K	REF.	W	LUMEN	⊙	⚙	REF. DALI
IP 20	2700	PI32MB	29,6 W	2940 lm	⊙	0,8	PI32DMB
UGR 22	3000	PI33MB	29,6 W	3170 lm	⊙	0,8	PI33DMB
	4000	PI34MB	29,6 W	3410 lm	⊙	0,8	PI34DMB

⊙ RAL9016

● RAL9005 Replace "B" by "N" in the reference

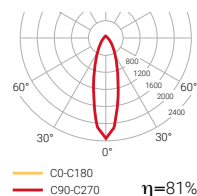

DALI Compatible with NormaLINK

# Silk

Electrified track

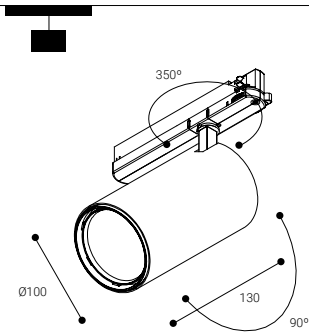

60000 h. L80B10 | CRI >90 |  $\Delta$  15-55° | Efficiency (%) 87

Photobiological safety

RG1\* **1** Low risk

\*Time under 3 h.

Go to page 443 to learn more

## EXTENSIVE OPTICS



36°

	K	REF.	W	LUMEN			REF. DALI
IP 20	2700	PI32FB	29,6W	2940 lm		0,8	PI32DFB
UGR 22	3000	PI33FB	29,6W	3170 lm		0,8	PI33DFB
	4000	PI34FB	29,6W	3410 lm		0,8	PI34DFB

- RAL9016
- RAL9005 Replace "B" by "N" in the reference

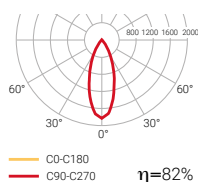

## VERY EXTENSIVE OPTICS

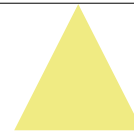

55°

	K	REF.	W	LUMEN			REF. DALI
IP 20	2700	PI32WB	29,6W	2940 lm		0,8	PI32DWB
UGR 22	3000	PI33WB	29,6W	3170 lm		0,8	PI33DWB
	4000	PI34WB	29,6W	3410 lm		0,8	PI34DWB

- RAL9016
- RAL9005 Replace "B" by "N" in the reference

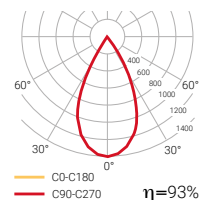

# Aqa



Aqa is the new cylindric projector: elegant, attractive and tough.

---

## Optics

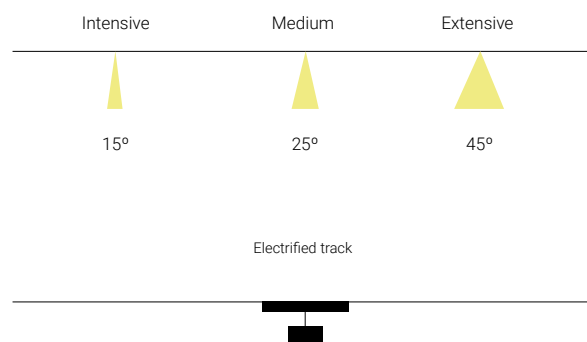



ESPA  
CA  
MISION

DIRECCION



 FITTING INTEGRATED  
IN THE ELECTRIFIED TRACK ADAPTER



## Aqa

Installation	Electrified track
Diffuser	☉
Light source	LED
Photobiological safety	1
UGR	19
CRI	>80
MacAdam ellipse	3
Beam angle range	15-45
Power range (W)	11,8-25,1
Colour temperature (°K)	3000   4000
Light range	1930-3780
Power factor	0,97
Efficiency (%)	81,8
Expectancy	60000 h L70B10
DALI Option	✓
Continuous operation 24h	✓
IP	20
Class	II
Energy efficiency	B   C

☉ Without diffuser



RAL9016



RAL9005

 For other CRI values,  
please contact us.



## The design-lighting binomial

Architecture and light, interior design and practicality, design and visual comfort. When creating pleasant, attractive spaces for people, lighting is an essential element to achieve a perfect result. Unleash the potential of a modern, flexible and elegant solution to enhance any scene with light, focusing on details based on the characteristics of each location.



# Aqa

Electrified track

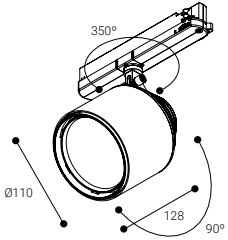

60000 h. L70B10 | CRI >80 | 15-45° | Efficiency (%) 81,8

Photobiological safety

RG1\* **1** Low risk

\*Time under 3h.

Go to page 443 to learn more

## INTESIVE OPTICS

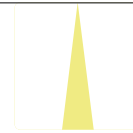

15°

	K	REF.	W	LUMEN			REF. DALI
IP 20	3000	PQ23SB	11,8 W	1930 lm		1,1	PQ23DSB
		PQ33SB	19,1 W	2650 lm		1,1	PQ33DSB
UGR 19	4000	PQ43SB	25,1 W	3580 lm		1,1	PQ43DSB
		PQ24SB	11,8 W	2050 lm		1,1	PQ24DSB
		PQ34SB	19,1 W	2850 lm		1,1	PQ34DSB
		PQ44SB	25,1 W	3780 lm		1,1	PQ44DSB

RAL9016

RAL9005 Replace "B" by "N" in the reference

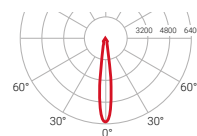

C0-C180  $\eta=82\%$   
C90-C270

Compatible with



# Aqa

Electrified track

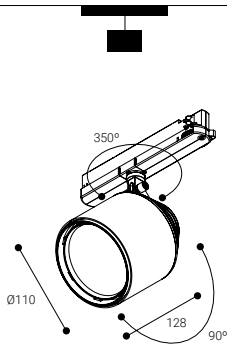

60000 h.  
L70B10

CRI  
>80

△  
15-45°

Efficiency (%)  
81,8

Photobiological safety

RG1\* **1** Low risk

\*Time under 3 h.

Go to page 443 to learn more

## MEDIUM OPTICS

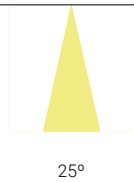

## EXTENSIVE OPTICS



	K	REF.	W	LUMEN			REF. DALI
IP 20	3000	PQ23MB	11,8 W	1930 lm	○	1,1	PQ23DMB
		PQ33MB	19,1 W	2650 lm	○	1,1	PQ33DMB
		PQ43MB	25,1 W	3580 lm	○	1,1	PQ43DMB
UGR 19	4000	PQ24MB	11,8 W	2050 lm	○	1,1	PQ24DMB
		PQ34MB	19,1 W	2850 lm	○	1,1	PQ34DMB
		PQ44MB	25,1 W	3780 lm	○	1,1	PQ44DMB

	K	REF.	W	LUMEN			REF. DALI
IP 20	3000	PQ23FB	11,8 W	1930 lm	○	1,1	PQ23DFB
		PQ33FB	19,1 W	2650 lm	○	1,1	PQ33DFB
		PQ43FB	25,1 W	3580 lm	○	1,1	PQ43DFB
UGR 19	4000	PQ24FB	11,8 W	2050 lm	○	1,1	PQ24DFB
		PQ34FB	19,1 W	2850 lm	○	1,1	PQ34DFB
		PQ44FB	25,1 W	3780 lm	○	1,1	PQ44DFB

- RAL9016
- RAL9005 Replace "B" by "N" in the reference

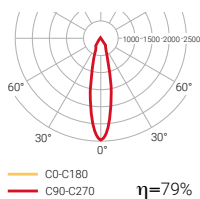

- RAL9016
- RAL9005 Replace "B" by "N" in the reference

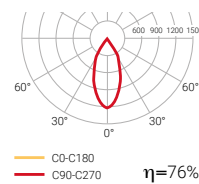

# Dot



DOT is a square shaped projector for commercial buildings and exhibitions.

## Optics

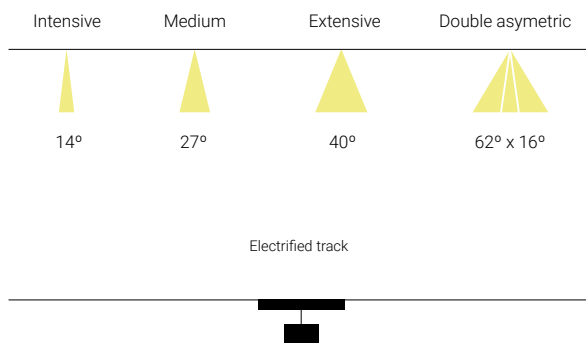



## Dot

Installation	Electrified track
Diffuser	☉
Light source	LED
Photobiological safety	1
UGR	19
CRI	>90
MacAdam ellipse	3
Beam angle range	14-62
Power range (W)	24,6
Colour temperature (°K)	3000   4000
Light range	2700
Power factor	0,9
Efficiency (%)	91,3
Expectancy	50000 h L70B10
DALI Option	✓
Continuous operation 24h	✓
IP	20
Class	II
Energy efficiency	E

☉ Without diffuser

**+** FITTING INTEGRATED IN THE ELECTRIFIED RAIL ADAPTER

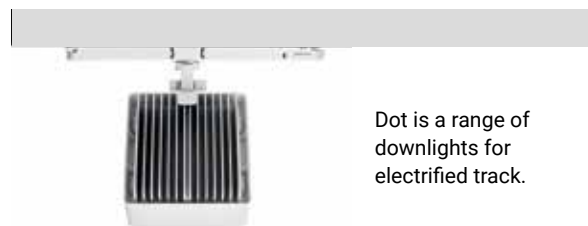

Dot is a range of downlights for electrified track.



RAL9016



RAL9005

**CRI 360** | For other CRI values, please contact us.

# Dot

Electrified track

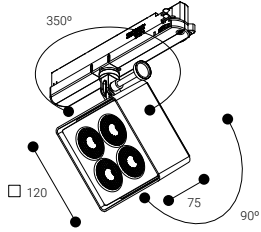

50000 h. L70B10 | CRI >90 | 14-62° | Efficiency (%) 91,3

Photobiological safety

RG1\* 1 Low risk

\*Time under 3 h.

Go to page 443 to learn more



## INTESIVE OPTICS



	K	REF.	W	LUMEN			REF. DALI
IP 20	3000	PD33SB	24,6 W	2700 lm		1,0	PD33DSB
UGR 19	4000	PD34SB	24,6 W	2700 lm		1,0	PD34DSB

- RAL9016
- RAL9005 Replace "B" by "N" in the reference

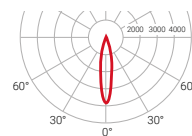

Compatible with

C0-C180 C90-C270  $\eta=85\%$

# Dot

Electrified track

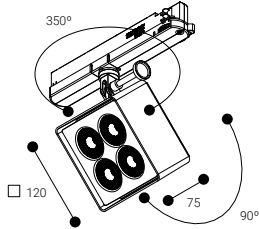

50000 h.  
L70B10

CRI  
>90

△  
14-62°

Efficiency (%)  
91,3

Photobiological safety

RG1\* **1** Low risk

\*Time under 3 h.

Go to page 443 to learn more

## MEDIUM OPTICS



27°

	K	REF.	W	LUMEN			REF. DALI
IP 20	3000	PD33MB	24,6 W	2700 lm		1,0	PD33DMB
UGR 19	4000	PD34MB	24,6 W	2700 lm		1,0	PQ34DMB

## EXTENSIVE OPTICS



40°

	K	REF.	W	LUMEN			REF. DALI
IP 20	3000	PD33FB	24,6 W	2700 lm		1,0	PD33DFB
UGR 19	4000	PD34FB	24,6 W	2700 lm		1,0	PD34DFB

- RAL9016
- RAL9005 Replace "B" by "N" in the reference

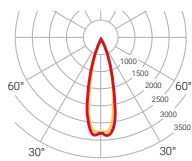

— C0-C180  
— C90-C270  $\eta=91\%$



- RAL9016
- RAL9005 Replace "B" by "N" in the reference

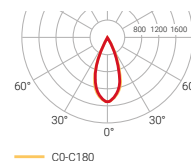

— C0-C180  
— C90-C270  $\eta=83\%$



# Dot

Electrified track

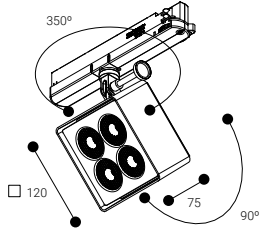

<b>50000 h.</b> L70B10	CRI <b>&gt;90</b>	<b>14-62°</b>	Efficiency (%) <b>91,3</b>
---------------------------	----------------------	---------------	-------------------------------

Photobiological safety

**RG1\*** **1** Low risk

\*Time under 3 h.

Go to page 443 to learn more



## OVAL OPTIC

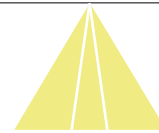

62° x 16°

	K	REF.	W	LUMEN			REF. DALI
IP <b>20</b>	3000	<b>PD330B</b>	24,6 W	2700 lm	○	1,0	<b>PD33DOB</b>
UGR <b>19</b>	4000	<b>PD340B</b>	24,6 W	2700 lm	○	1,0	<b>PD34DOB</b>

- RAL9016
- RAL9005 Replace "B" by "N" in the reference

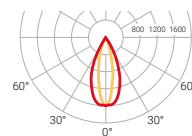

— C0-C180  
— C90-C270  $\eta=73\%$





# Area



AREA is a versatile projector that is ideal for spot lighting in commercial areas and exhibitions.

## Optics

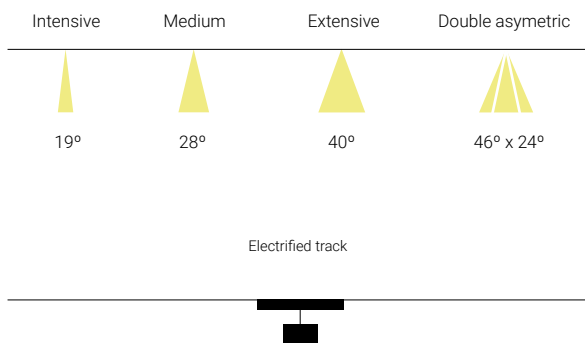





## Area

Installation	Electrified track
Diffuser	☉
Light source	LED
Photobiological safety	1
UGR	19
CRI	>80
MacAdam ellipse	3
Beam angle range	19-46
Power range (W)	25,5-51
Colour temperature (°K)	3000   4000
Light range	2580-5530
Power factor	0,9
Efficiency (%)	91,3
Expectancy	50000 h L70B10
DALI Option	✓
Continuous operation 24h	✓
IP	20
Class	I
Energy efficiency	E

AREA is a range of projectors to be installed in electrified track or Surface ceiling mounted using an accessory.



RAL9016



RAL9005

☉ PMMA lens

**CRI 360** | For other CRI values, please contact us.

# Area

Electrified track

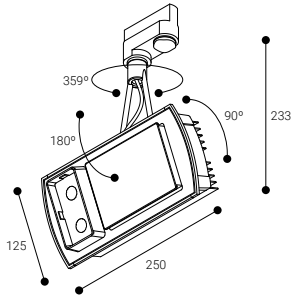

50000 h. L70B10 | CRI >80 | 19-46° | Efficiency (%) 91,3

Photobiological safety

RG1\* 1 Low risk

\*Time under 3 h.

Go to page 443 to learn more



## Simple model

### INTESIVE OPTICS



	K	REF.	W	LUMEN			REF. DALI
IP 20	3000	PAC33SB	25,5 W	2580 lm	○	2,0	PAC33DSB
UGR 19	4000	PAC34SB	25,5 W	2765 lm	○	2,0	PAC34DSB

- RAL9016
- RAL9005 Replace "B" by "N" in the reference

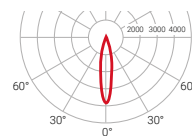

DALI Compatible with NormaLINK

C0-C180 η=85%  
C90-C270

# Area

Electrified track

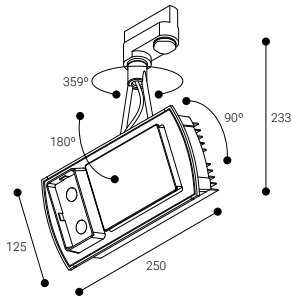

50000 h.  
L70B10

CRI  
>80

19-46°

Efficiency (%)  
91,3

Photobiological safety

RG1\* **1** Low risk

\*Time under 3 h.

Go to page 443 to learn more

## Simple model

### MEDIUM OPTICS



28°

	K	REF.	W	LUMEN			REF. DALI
IP 20	3000	PAC33MB	25,5 W	2580 lm		2,0	PAC33DMB
UGR 19	4000	PAC34MB	25,5 W	2765 lm		2,0	PAC34DMB

### EXTENSIVE OPTICS



40°

	K	REF.	W	LUMEN			REF. DALI
IP 20	3000	PAC33FB	25,5 W	2580 lm		2,0	PAC33DFB
UGR 19	4000	PAC34FB	25,5 W	2765 lm		2,0	PAC34DFB

- RAL9016
- RAL9005 Replace "B" by "N" in the reference

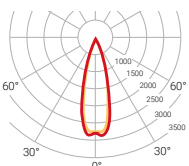

C0-C180  
C90-C270  $\eta=91\%$



- RAL9016
- RAL9005 Replace "B" by "N" in the reference

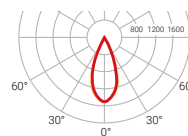

C0-C180  
C90-C270  $\eta=83\%$



# Area

Electrified track

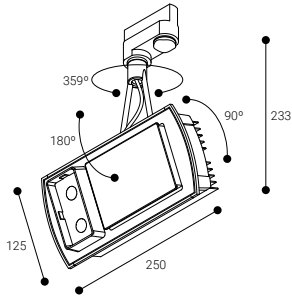

<b>50000 h.</b> L70B10	CRI <b>&gt;80</b>	<b>19-46°</b>	Efficiency (%) <b>91,3</b>
---------------------------	----------------------	---------------	-------------------------------

Photobiological safety

**RG1\*** **1** Low risk

\*Time under 3 h.

**Go to page 443 to learn more**



## Simple model

### OVAL OPTICS



46° x 24°

	K	REF.	W	LUMEN			REF. DALI
IP <b>20</b>	3000	<b>PAC330B</b>	25,5 W	2580 lm		2,0	<b>PAC33DOB</b>
UGR <b>19</b>	4000	<b>PAC340B</b>	25,5 W	2765 lm		2,0	<b>PAC34DOB</b>

- RAL9016
- RAL9005 Replace "B" by "N" in the reference

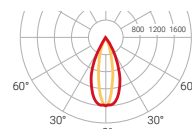

C0-C180  $\eta=73\%$   
C90-C270



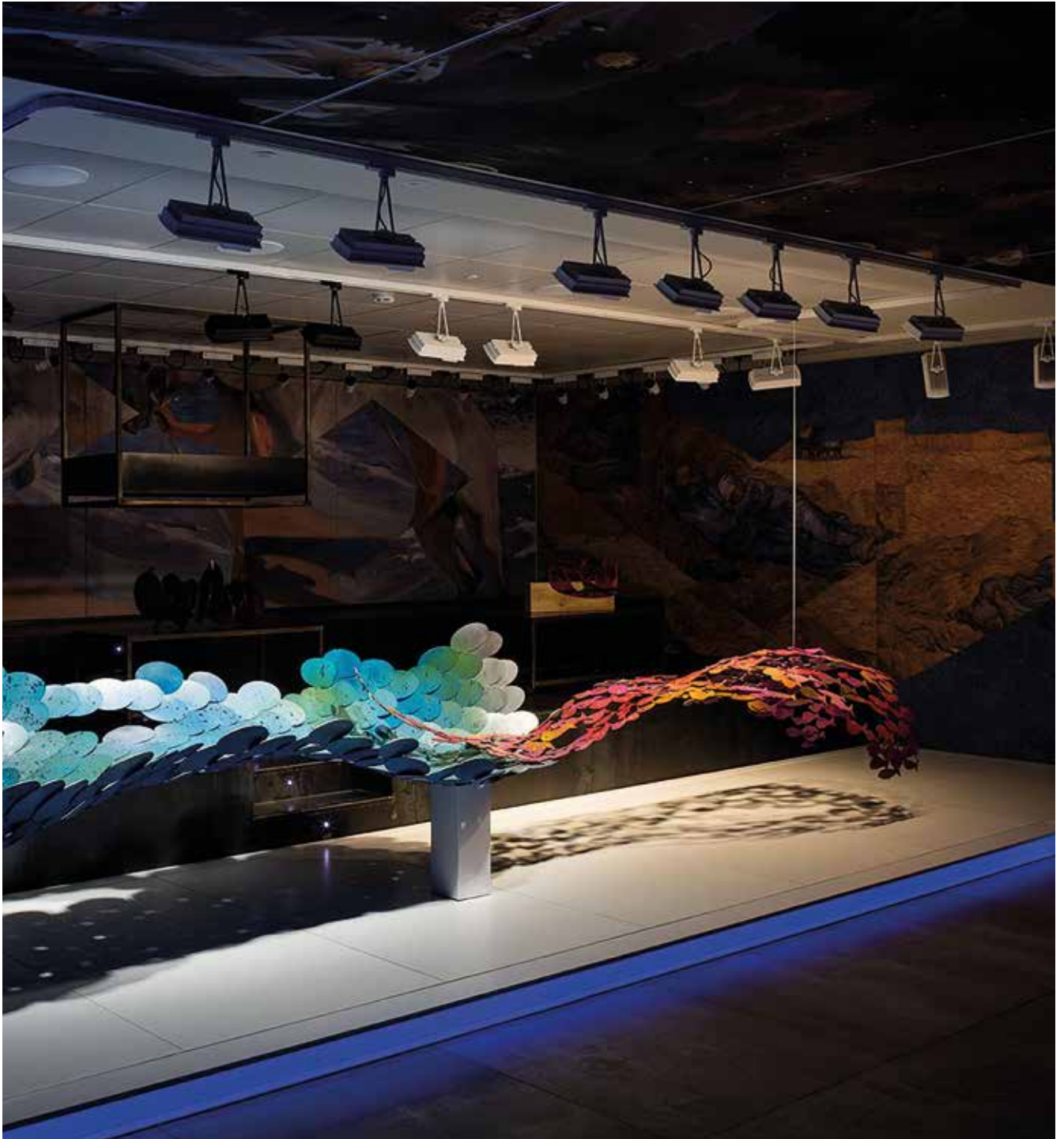

# Area

Electrified track



LED CE ENEC

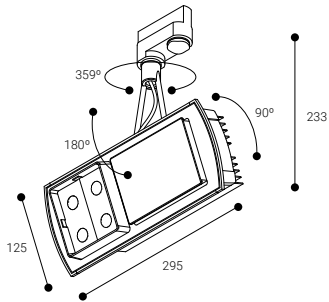

50000 h. L70B10 | CRI >80 | 19-46° | Efficiency (%) 91,3

Photobiological safety

RG1\* 1 Low risk

\*Time under 3 h.

Go to page 443 to learn more



## Double model

### INTENSIVE OPTICS



19°

	K	REF.	W	LUMEN			REF. DALI
IP 20	3000	PAC53SB	51 W	5160 lm	○	3,0	PAC53DSB
UGR 19	4000	PAC54SB	51 W	5530 lm	○	3,0	PAC54DSB

- RAL9016
- RAL9005 Replace "B" by "N" in the reference

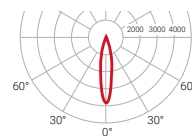

— C0-C180  
— C90-C270  $\eta=85\%$

DALI Compatible with NormaLINK

# Area

Electrified track

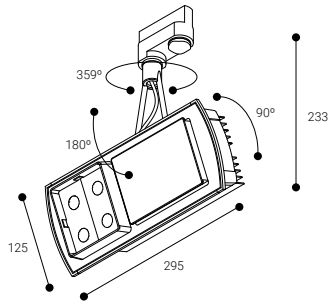

50000 h.  
L70B10

CRI  
>80

19-46°

Efficiency (%)  
91,3

Photobiological safety

RG1\* **1** Low risk

\*Time under 3 h.

Go to page 443 to learn more

## Double model

### MEDIUM OPTICS



28°

	K	REF.	W	LUMEN			REF. DALI
IP 20	3000	<b>PAC53MB</b>	51 W	5160 lm		3,0	<b>PAC53DMB</b>
UGR 19	4000	<b>PAC54MB</b>	51 W	5530 lm		3,0	<b>PAC54DMB</b>

### EXTENSIVE OPTICS



40°

	K	REF.	W	LUMEN			REF. DALI
IP 20	3000	<b>PAC53FB</b>	51 W	5160 lm		3,0	<b>PAC53DFB</b>
UGR 19	4000	<b>PAC54FB</b>	51 W	5530 lm		3,0	<b>PAC54DFB</b>

- RAL9016
- RAL9005 Replace "B" by "N" in the reference

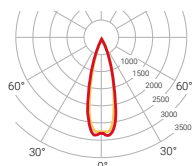

— C0-C180  
— C90-C270  $\eta=91\%$



- RAL9016
- RAL9005 Replace "B" by "N" in the reference

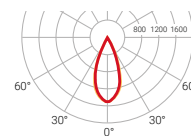

— C0-C180  
— C90-C270  $\eta=83\%$



# Area

Electrified track

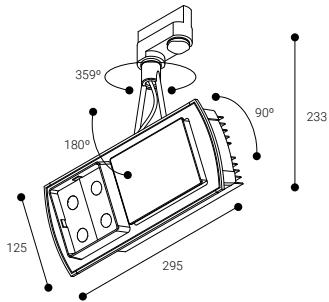

50000 h.  
L70B10

CRI  
>80

19-46°

Efficiency (%)  
91,3

Photobiological safety

RG1\* **1** Low risk

\*Time under 3 h.

Go to page 443 to learn more



## Double model

### OVAL OPTICS



46° x 24°

	K	REF.	W	LUMEN			REF. DALI
IP 20	3000	<b>PAC530B</b>	51 W	5160 lm	○	3,0	<b>PAC53DOB</b>
UGR 19	4000	<b>PAC540B</b>	51 W	5530 lm	○	3,0	<b>PAC54DOB</b>

○ RAL9016

● RAL9005 Replace "B" by "N" in the reference

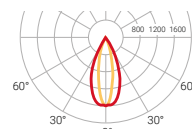

— C0-C180  
— C90-C270  $\eta=73\%$

**DALI** Compatible with **NormaLINK**



# Area

---

ACCESSORIES

Ceiling mounted accessory

RAAB  
RAAN

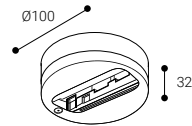

 NOT COMPATIBLE  
WITH DALI FITTINGS

# Prolit



The PROLIT projectors stand out thanks to their versatility and the fact that they can be installed in an electric track or mounted on the wall or in the ceiling.



**60000 h.**  
L70B10

CRI  
**>80**

$\Delta$   
**32°**

Efficiency (%)  
**92,2**

Photobiological safety

**RG0** **0** Risk free

\*Time under 3h:

**Go to page 443 to learn more**

Surface ceiling mounted

Electrified track





## Prolit

Installation	Surface ceiling mounted Electrified track
Diffuser	☉
Light source	LED
Photobiological safety	1
UGR	19
CRI	>80
MacAdam ellipse	3
Beam angle range	32
Power range (W)	11,8-19,4
Colour temperature (°K)	3000   4000
Light range	1930-2850
Power factor	0,95
Efficiency (%)	92,2
Expectancy	60000 h L70B10
DALI Option	✓
Continuous operation 24h	✓
IP	20
Class	II
Energy efficiency	B   C

☉ Without diffuser

**CRI 360** | For other CRI values,  
please contact us.

### + FITTING INTEGRATED IN THE ELECTRIFIED RAIL ADAPTER



RAL9016



RAL9005

The head and the body are made of aluminium injection with a minimalist design. The entire set is lacquered with an epoxy-polyester paint with two different finishes: white or black.

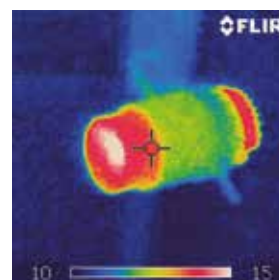

Please request technical specifications of all the luminaires or visit our website.

# Prolit

Surface ceiling mounted

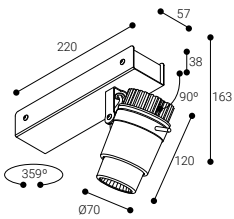

<b>60000 h.</b> L70B10	CRI <b>&gt;80</b>	<b>32°</b>	Efficiency (%) <b>92,2</b>
---------------------------	----------------------	------------	-------------------------------

Photobiological safety

**RG0** **0** Risk free

\*Time under 3 h.

**Go to page 443 to learn more**



## INTENSIVE OPTICS

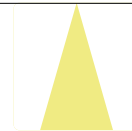

32°

	K	REF.	W	LUMEN			REF. DALI
IP 20	3000	<b>PRA23SB</b>	11,8 W	1930 lm		1,1	—
		<b>PRA33SB</b>	17,4 W	2650 lm		1,1	—
UGR 19	4000	<b>PRA24SB</b>	11,8 W	2050 lm		1,1	—
		<b>PRA34SB</b>	17,4 W	2850 lm		1,1	—

- RAL9016
- RAL9005 Replace "B" by "N" in the reference

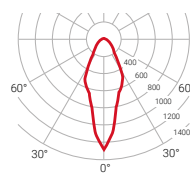

— C0-C180  
— C90-C270 **η=92%**

# Prolit

Electrified track

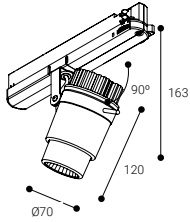

60000 h.  
L70B10

CRI  
>80

32°

Efficiency (%)  
92,2

Photobiological safety

RG0 **0** Risk free

\*Time under 3 h.

Go to page 443 to learn more



## INTENSIVE OPTICS

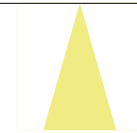

32°

	K	REF.	W	LUMEN			REF. DALI
IP 20	3000	PR <b>S</b> 23 <b>S</b> B	11,8 W	1930 lm		1,1	PR <b>S</b> 23 <b>D</b> S <b>B</b>
		PR <b>S</b> 33 <b>S</b> B	17,4 W	2650 lm		1,1	PR <b>S</b> 33 <b>D</b> S <b>B</b>
UGR 19	4000	PR <b>S</b> 24 <b>S</b> B	11,8 W	2050 lm		1,1	PR <b>S</b> 24 <b>D</b> S <b>B</b>
		PR <b>S</b> 34 <b>S</b> B	17,4 W	2850 lm		1,1	PR <b>S</b> 34 <b>D</b> S <b>B</b>

○ RAL9016

● RAL9005 Replace "B" by "N" in the reference

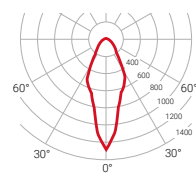

— C0-C180  
— C90-C270  $\eta=92\%$

**DALI** Compatible with **NormaLINK**

# Avalon



AVALON is the new family of Normalit outdoor projectors. Are available in seven sizes, covering a power range from 9W to 180W.

 **54000 h.**  
L70B10

Efficiency (%)  
**92,1**

**IP 66** 

Wall surface mounted

Photobiological safety

**RG1\***  Low risk

\*Time under 3h.

**Go to page 443 to learn more**

Surface ceiling mounted



## Avalon

Installation	Surface ceiling mounted Wall surface mounted
Diffuser	⊙
Light source	LED
Photobiological safety	1
UGR	22
CRI	>80
MacAdam ellipse	3
Beam angle range	108
Power range (W)	9-180
Colour temperature (°K)	3000   4000
Light range	1250-26030
Power factor	0,95
Efficiency (%)	92,1
Expectancy	54000 h L70B10
DALI Option	–
Continuous operation 24h	✓
IP	66
IK	09
Class	I
Energy efficiency	C

⊙ PMMA lens



### The perfect surface-mounted projector

Its availability in seven sizes and up to four versions make the AVALON family the most complete line of projectors for surface-mounted installation, ideal for all types of outdoor and indoor high-ceiling installations.

Versions:

- AV.** Standard Version On/off
- AVS.** Version with occupancy detector
- AVC.** Version with twilight sensor
- AVX.** Version with Dip-Switch technology or adjustable lumen output



## Save energy automatically

AVALON integrates multiple automatic lighting regulation options that allows the equipment to be adapted to various scenarios, with a high added value in system efficiency.



### Occupancy detector

Integrated into the equipment itself, it enables scheduled switching on of the projector to be activated at maximum power when motion is detected in the environment.

Available in the AVS version.



### Twilight sensor

The version with photocell detects low light levels, optimally adapting power in insufficient lighting conditions.

Available in AVC version.

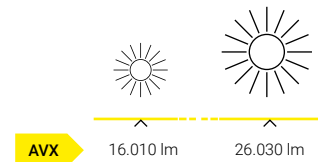

### New adjustable lumen output dip-switch technology

The AVALON AVX version integrates a selector to adjust the operating power of the projector, allowing the lumen output to be varied depending on the needs of an installation.





**Maximum resistance and duration**

A design specifically created to achieve maximum resistance outdoors, with the guarantee of the greatest durability of all its electronic components and materials.

IP66 

Its advanced regulation and control functions make Avalon the most flexible and efficient solution on the market.



**Optimized heat dissipation**

Designed exclusively in black, the AVALON family projectors are made with a cast aluminum body that optimizes heat dissipation, extending the lifetime of the fitting.

**Adjustable surface-mounted installation**

With an integrated regulation system to achieve a more flexible installation of the equipment on ceilings and walls.

 INCLUDES ANTI-CONDENSATION VALVE.

# Avalon

Surface ceiling mounted

LED CE ENEC

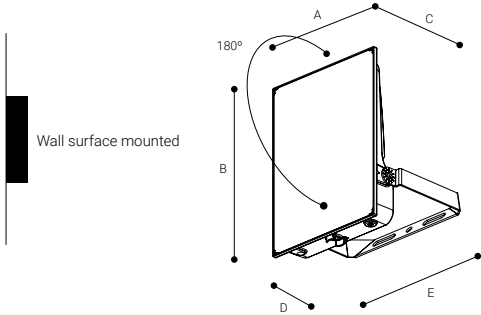

REFS.	mm				
	A	B	C	D	E
AV10.../AV20...	136	120	121	43,5	149
AV30.../AV50...	174	146	129	46	197
AV65...	154	205	159	47	175
AV80...	194	250	166	49	214
AV125...	229	275	176	53	252
AV165...	244	315	216	58	252
AV200...	276	357	238	62	303

54000 h.  
L70B10

CRI  
>80

108°

Efficiency (%)  
92,1

Photobiological safety

RG1\* 1 Low risk

\*Time under 3 h.

Go to page 443 to learn more



## STANDARD

	K	REF.	W	LUMEN		
IP 66	3000	AV10-3FN	9 W	1250 lm	●	0,8
		AV20-3FN	18 W	2620 lm	●	0,8
UGR 22	3000	AV30-3FN	27 W	4030 lm	●	1,2
		AV50-3FN	45 W	6270 lm	●	1,2
		AV65-3FN	58,5 W	8219 lm	●	1,6
		AV80-3FN	72 W	10520 lm	●	2,3
		AV125-3FN	112,5 W	16010 lm	●	3,2
		AV165-3FN	148,5 W	21290 lm	●	3,7
		AV200-3FN	180 W	25280 lm	●	4,6
		4000	3000	AV10-4FN	9 W	1330 lm
AV20-4FN	18 W			2820 lm	●	0,8
AV30-4FN	27 W			4210 lm	●	1,2
AV50-4FN	45 W			6390 lm	●	1,2
AV65-4FN	58,5 W			8550 lm	●	1,6
AV80-4FN	72 W			10940 lm	●	2,3
AV125-4FN	112,5 W			17530 lm	●	3,2
AV165-4FN	148,5 W			23260 lm	●	3,7
AV200-4FN	180 W	26030 lm	●	4,6		

● RAL9005

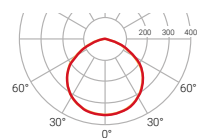

— C0-C180  
— C90-C270  $\eta=95\%$

# Avalon

Surface ceiling mounted

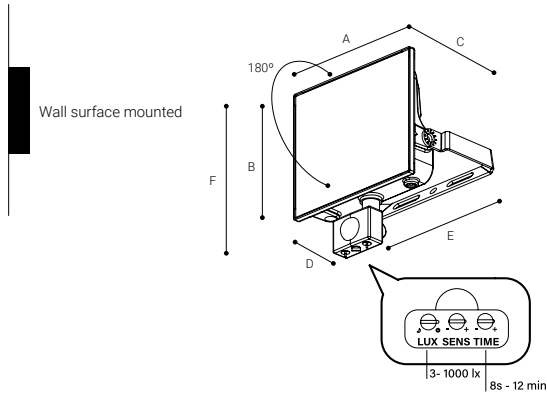

REFS.	A	B	C	D	E	F
AV10S.../AV20S...	136	120	121	43,5	149	185
AV30S.../AV50S...	174	146	129	46	197	210

54000 h.  
L70B10

CRI  
>80

108°

Efficiency (%)  
92,1

Photobiological safety

RG1\* **1** Low risk

\*Time under 3 h.

Go to page 443 to learn more



## OCCUPANCY DETECTOR

	K	REF.	W	LUMEN		
IP 66	3000	AV10S-3FN	9 W	1250 lm	●	0,8
		AV20S-3FN	18 W	2620 lm	●	0,8
UGR 22	4000	AV30S-3FN	27 W	4030 lm	●	1,2
		AV50S-3FN	45 W	6270 lm	●	1,2
	4000	AV10S-4FN	9 W	1330 lm	●	0,8
		AV20S-4FN	18 W	2820 lm	●	0,8
		AV30S-4FN	27 W	4210 lm	●	1,2
		AV50S-4FN	45 W	6390 lm	●	1,2

● RAL9005

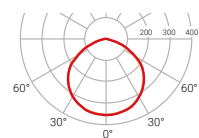

— C0-C180  
— C90-C270  $\eta=95\%$

# Avalon

Surface ceiling mounted

LED CE ENEC

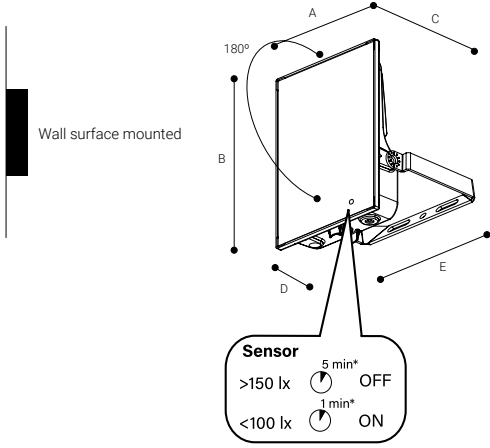

REFS.	mm				
	A	B	C	D	E
AV65C...	154	205	175	268	47
AV80C...	194	250	214	322	49
AV125C...	229	275	252	355	53
AV165C...	244	315	272	415	58
AV200C...	276	357	303	469	62

54000 h. L70B10 | CRI >80 | 108° | Efficiency (%) 92,1

Photobiological safety

RG1\* 1 Low risk

\*Time under 3 h.

Go to page 443 to learn more



## PHOTOCELL

	K	REF.	W	LUMEN		
IP 66	3000	AV65C-3FN	58,5 W	8219 lm	●	1,6
		AV80C-3FN	72 W	10520 lm	●	2,3
UGR 22		AV125C-3FN	112,5 W	16010 lm	●	3,2
		AV165C-3FN	148,5 W	21290 lm	●	3,7
		AV200C-3FN	180 W	25280 lm	●	4,6
4000		AV65C-4FN	58,5 W	8580 lm	●	1,6
		AV80C-4FN	72 W	10940 lm	●	2,3
		AV125C-4FN	112,5 W	17530 lm	●	3,2
		AV165C-4FN	148,5 W	23260 lm	●	3,7
		AV200C-4FN	180 W	26030 lm	●	4,6

● RAL9005

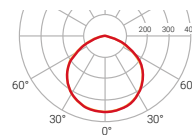

C0-C180 | C90-C270 |  $\eta=95\%$

# Avalon

Surface ceiling mounted

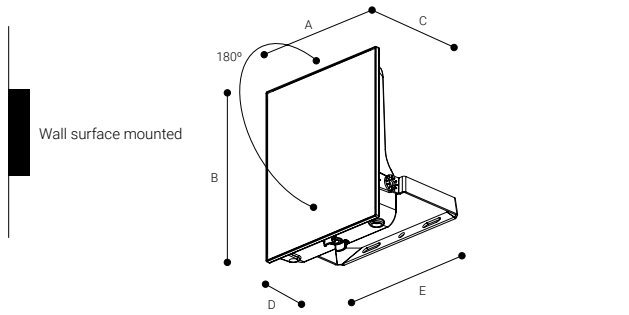

REFS.	mm				
	A	B	C	D	E
AVX125...	229	275	176	53	252
AVX200...	276	357	238	62	303

54000 h.  
L70B10

CRI  
>80

108°

Efficiency (%)  
92,1

Photobiological safety

RG1\* **1** Low risk

\*Time under 3 h.

Go to page 443 to learn more

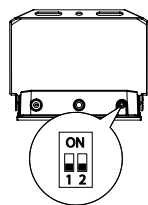

	AVX125			AVX200		
	125 W	80 W	65 W	2002 W	165 W	125 W
1	OFF	ON	OFF	OFF	OFF	ON
2	OFF	OFF	ON	OFF	ON	OFF



## DIP-SWITCH TECHNOLOGY

	K	REF.	W	LUMEN		
IP 66	3000	AVX125-3FN	112,5 W	16010 lm	●	3,2
		AVX200-3FN	180 W	25280 lm	●	0,0
UGR 22	4000	AVX125-4FN	112,5 W	17530 lm	●	3,2
		AVX200-4FN	180 W	26030 lm	●	0,0

● RAL9005

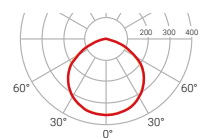

— C0-C180  
— C90-C270  $\eta=95\%$

# Nora



NORA is the new IP66 projector for outdoors installations.  
It is available in black and with glass diffuser



**50000 h.**  
L70B10

CRI  
**>80**

$\Delta$   
**96°**

Efficiency (%)  
**86,8**

Wall surface mounted

Photobiological safety

**RG0** **0** Risk free

\*Time under 3h:

**Go to page 443 to learn more**

Surface ceiling mounted



### Maximum protection

With an IP66 degree of protection, the housing is dust-tight and protects the luminaire from potential impacts and environmental conditions such as high humidity.

IP66 

## Nora

Installation Surface ceiling mounted  
Wall surface mounted

Diffuser 

Light source LED

Photobiological safety 0

UGR 22

CRI >80

MacAdam ellipse 3

Beam angle range 96

Power range (W) 18,2

Colour temperature (°K) 4000

Light range 2300

Power factor 0,9

Efficiency (%) 86,8

Expectancy 50000 h L70B10

DALI Option

Continuous operation 24h

IP 66

Class I

Energy efficiency D

 Opal diffuser



For other CRI values,  
please contact us.

# Nora

Surface ceiling mounted

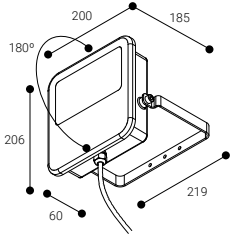
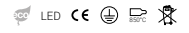

<b>50000 h.</b> L70B10	CRI <b>&gt;80</b>	<b>96°</b>	Efficiency (%) <b>86,8</b>
---------------------------	----------------------	------------	-------------------------------

Photobiological safety

**RG0** **0** Risk free

\*Time under 3 h.

**Go to page 443 to learn more**



## OPAL DIFFUSER



96°

	K	REF.	W	LUMEN			REF. DALI
IP <b>66</b>	4000	<b>N034ON</b>	18,2 W	2300 lm		1,7	<b>N034DON</b>
UGR <b>22</b>							

**RAL9005**

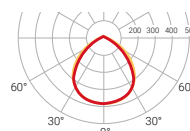

C0-C180  
C90-C270  $\eta=87\%$







# Ambient





Mural  
412



Cyre P  
416



Til  
418



Uro  
420



Passo  
422

# Mural

---

Wall mounted luminaire with direct illumination (Mural) or direct/indirect (Mural Mixto) available in three different finishes: white, grey or black.

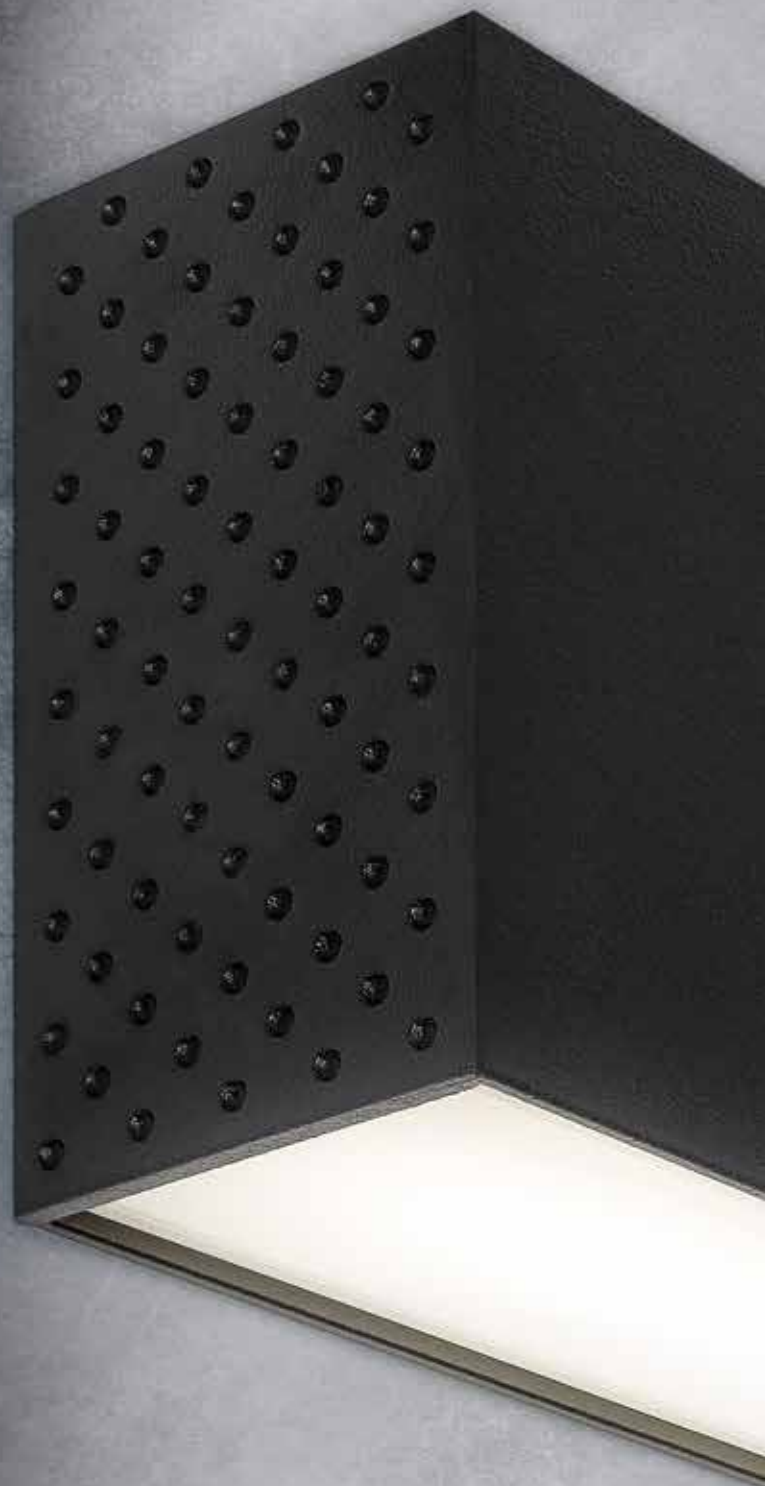



Direct illumination



Direct/indirect illumination



## Mural

## Mural Mixto

Installation	Wall surface mounted	Wall surface mounted
Diffuser	☉	
Light source	LED	LED
Photobiological safety	0	1
UGR	22	22
CRI	>80	>80
MacAdam ellipse	3	3
Beam angle range	113	113
Power range (W)	6,7-9,5	13,4-19
Colour temperature (°K)	3000   4000	3000   4000
Light range	760-1290	1520-2580
Power factor	0,95	0,95
Efficiency (%)	65,9	67
Expectancy	72000 h L70B10	72000 h L70B10
DALI Option	—	—
Continuous operation 24h	✓	✓
IP	30	30
Class	I	I
Energy efficiency	D   E	D   E

☉ Opal diffuser



RAL9016



RAL7001



RAL9005



For other CRI values, please contact us.

# Mural

LED CE ENEC

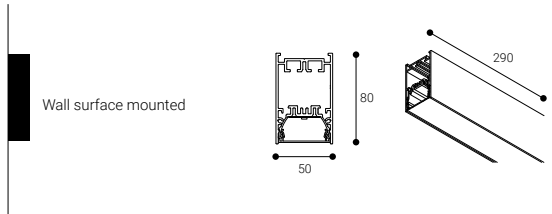

72000 h.  
L70B10

CRI  
>80

113°

Efficiency (%)  
65,9

Photobiological safety

RG0 0 Risk free

\*Time under 3 h.

Go to page 443 to learn more



## DIRECT ILLUMINATION

	K	REF.	W	LUMEN			REF. DALI
IP 30	3000	<b>MD1L3B</b>	6,7 W	760 lm	○	0,8	—
		<b>MD1H3B</b>	9,5 W	1160 lm	○	0,8	—
UGR 22	4000	<b>MD1L4B</b>	6,7 W	840 lm	○	0,8	—
		<b>MD1H4B</b>	9,5 W	1290 lm	○	0,8	—

- RAL9016
- RAL7001 Replace "B" by "G" in the reference
- RAL9005 Replace "B" by "N" in the reference

Opal diffuser

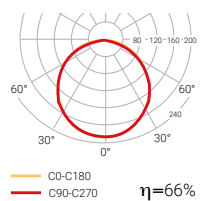

# Mural Mixto

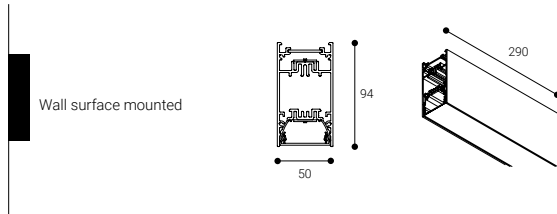

72000 h.  
L70B10

CRI  
>80

113°

Efficiency (%)  
67

Photobiological safety

RG1\* **1** Low risk

\*Time under 3 h.

Go to page 443 to learn more



## DIRECT/INDIRECT ILLUMINATION

	K	REF.	W	LUMEN			REF. DALI
IP 30	3000	MM1L3B	13,4 W	1520 lm		1,1	—
		MM1H3B	19 W	2320 lm		1,1	—
UGR 22	4000	MM1L4B	13,4 W	1680 lm		1,1	—
		MM1H4B	19 W	2580 lm		1,1	—

- RAL9016
- RAL7001 Replace "B" by "G" in the reference
- RAL9005 Replace "B" by "N" in the reference

Opal diffuser

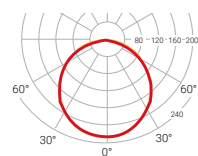

— C0-C180  
— C90-C270  $\eta=66\%$

Indirect Opal diffuser

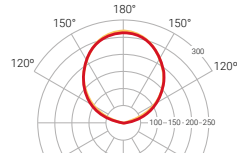

— C0-C180  
— C90-C270  $\eta=68\%$

# Cyre P

Installation	Wall surface mounted
Diffuser	⊙
Light source	LED
Photobiological safety	1
UGR	19
CRI	>80
MacAdam ellipse	4
Beam angle range	94
Power range (W)	6,4
Colour temperature (°K)	3000   4000
Light range	760-885
Power factor	0,5
Efficiency (%)	92,9
Expectancy	60000 h L70B10
DALI Option	✓
Continuous operation 24h	✓
IP	20
Class	I
Energy efficiency	C   D

⊙ Without diffuser



For other CRI values,  
please contact us.



# Cyre P

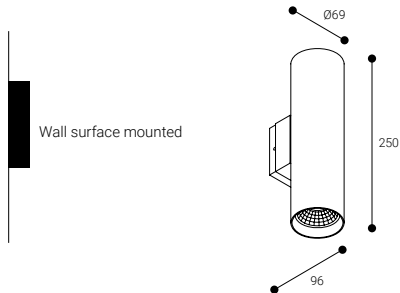

60000 h. L70B10 | CRI >80 |  $\Delta$  94° | Efficiency (%) 92,9

Photobiological safety

RG1\* **1** Low risk

\*Time under 3 h.

Go to page 443 to learn more



## ⊙ WITHOUT DIFFUSER

	K	REF.	W	LUMEN			REF. DALI
IP 20	3000	<b>AC03B</b>	6,4 W	760 lm	○	0,8	<b>AC03DB</b>
UGR 19	4000	<b>AC04B</b>	6,4 W	885 lm	○	0,8	<b>AC04DB</b>

- RAL9016
- RAL9005 Replace "B" by "N" in the reference

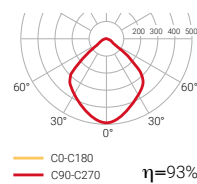

RAL9016



RAL7001

# Til

Installation	Wall surface mounted
Diffuser	☉
Light source	LED
Photobiological safety	0
UGR	22
CRI	>80
MacAdam ellipse	3
Beam angle range	30
Power range (W)	6
Colour temperature (°K)	3000   4000
Light range	535-615
Power factor	0,5
Efficiency (%)	17,6
Expectancy	36000 h L70B10
DALI Option	–
Continuous operation 24h	✓
IP	20
Class	I
Energy efficiency	F

☉ Without diffuser



For other CRI values,  
please contact us.

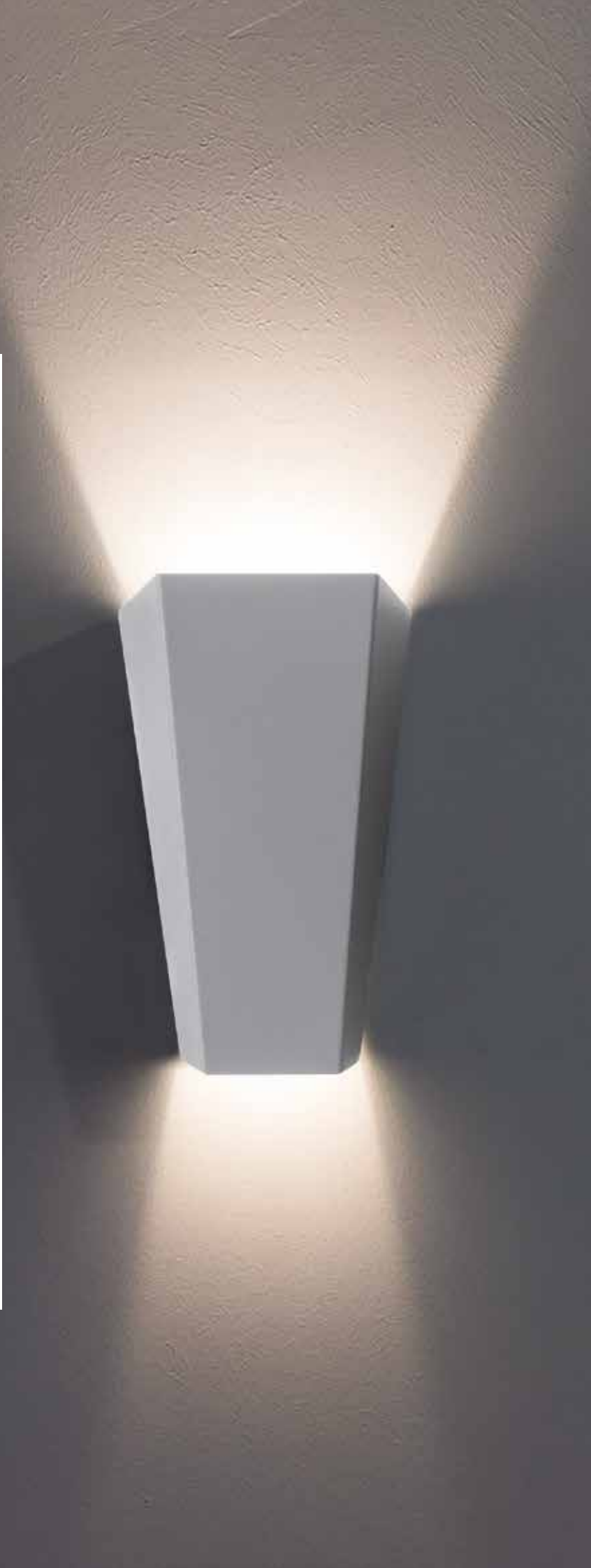

# Til

LED CE ENEC

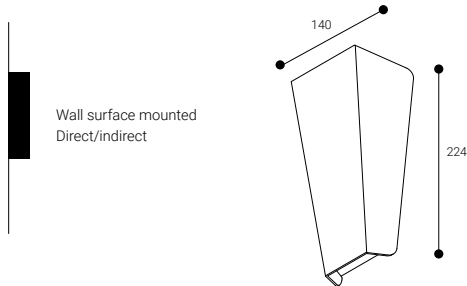

36000 h.  
L70B10

CRI  
>80

30°

Efficiency (%)  
17,6

Photobiological safety

RG0 **0** Risk free

\*Time under 3 h.

Go to page 443 to learn more



## WITHOUT DIFFUSER

	K	REF.	W	LUMEN			REF. DALI
IP <b>20</b>	3000	<b>AT3B</b>	6 W	535 lm		0,6	—
UGR <b>22</b>	4000	<b>AT4B</b>	6 W	615 lm		0,6	—

Up to 5 years warranty (prior studying each project)



RAL9016



RAL7001



RAL9005

- RAL9016
- RAL7001 Replace "B" by "G" in the reference
- RAL9005 Replace "B" by "N" in the reference

# Uro



Installation	Surface ceiling mounted Wall surface mounted
--------------	-------------------------------------------------

Diffuser	☉
----------	---

Light source	LED
--------------	-----

Photobiological safety	0
------------------------	---

UGR	22
-----	----

CRI	>80
-----	-----

MacAdam ellipse	3
-----------------	---

Beam angle range	120
------------------	-----

Power range (W)	12,6
-----------------	------

Colour temperature (°K)	3000   4000
-------------------------	-------------

Light range	1620-1770
-------------	-----------

Power factor	0,95
--------------	------

Efficiency (%)	76,5
----------------	------

Expectancy	54000 h L70B10
------------	----------------

DALI Option	✓
-------------	---

Continuous operation 24h	✓
--------------------------	---

IP	65
----	----

IK	10
----	----

Class	II
-------	----

Energy efficiency	C   D
-------------------	-------

☉ Opal diffuser

# Uro

Surface ceiling mounted

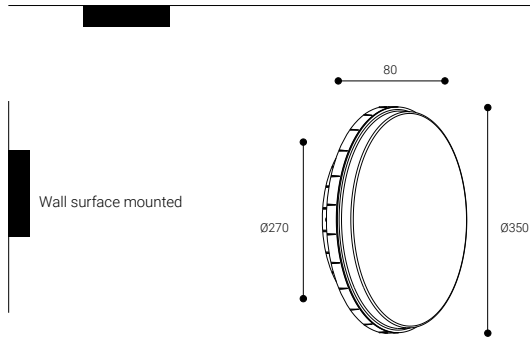

<b>54000 h.</b> L70B10	CRI <b>&gt;80</b>	<b>120°</b>	Efficiency (%) <b>76,5</b>	IK <b>10</b>
---------------------------	----------------------	-------------	-------------------------------	-----------------

Photobiological safety

**RG0** **0** Risk free

\*Time under 3 h.

Go to page 443 to learn more



## OPAL DIFFUSER

	K	REF.	W	LUMEN			REF. DALI
IP <b>65</b>	3000	<b>AU23B</b>	12,6 W	1620 lm	○	1,4	<b>AU23DB</b>
UGR <b>22</b>	4000	<b>AU24B</b>	12,6 W	1770 lm	○	1,4	<b>AU24DB</b>

- RAL9016
- RAL7001 Replace "B" by "G" in the reference
- RAL9005 Replace "B" by "N" in the reference

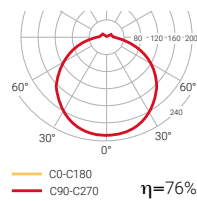

RAL9016



RAL7001



RAL9005

## ACCESSORY

### AUKM

Semi recessed  
URO installation kit

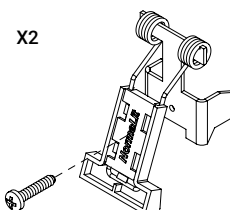

# Passo

Installation	Recessed to the floor Step recessed
Light source	LED
Photobiological safety	0
Beam angle range	120
Power range (W)	0,25
DALI Option	–
Continuous operation 24h	✓
IP	65
IK	07
Class	III



# Passo

Recessed to the floor

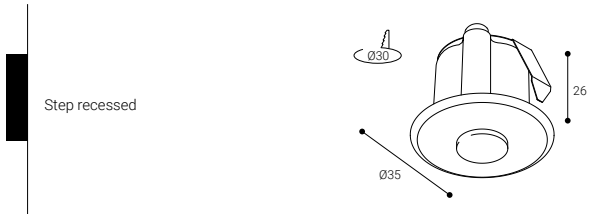

120° IK 07

Photobiological safety  
**RG0** **0** Risk free  
\*Time under 3 h.  
 Go to page 443 to learn more



	REF.	LED COLOUR	W		
IP 65	<b>BP12</b>	○	0,25 W	○	0,1
	<b>BP12A</b>	●	0,25 W	○	0,1
	<b>BP12R</b>	●	0,25 W	○	0,1
	<b>BP12V</b>	●	0,25 W	○	0,1

Up to 5 years warranty (prior studying each project)

Passo is a small-sized signalling step light. Available in three different finishes, it can be combined with four colours of LED ensuring its integration into any installation thanks to its 12 different possible combinations. These step lights are powered at 12 Vcc, which is why they need an additional power source to ensure they function correctly.

○ RAL9016

IP65





## What is Normalink?

Normalink is an advanced system to control general lighting and monitor emergency lighting (emergency luminaires and exit signs).

### FREE APP

Available for IOS and Android



Normalink provides control via the following applications:

**Normalink App**  
for IOS or Android.  
Also available for computers  
compatible with Windows.

Control via **Normalink BMS**  
drawings for computers  
compatible with Windows.

Via the **BMS** (Building  
Management System)  
**software** compatible with the  
Modbus/IP protocol.







## Normalink compatibility

- Compatible with **DALI** general lighting and emergency lighting
- Compatible with **SALUZ Tunable White**<sup>(1)</sup> luminaires and other **DALI DT8**<sup>(2)</sup> equipment.
- Compatible with **Normalux**<sup>(3)</sup> **INTELLIGENT WIRELESS** emergency lighting and exit signs.
- Compatible with **Modbus/IP**<sup>(4)</sup>.

<sup>(1)</sup> SALUZ Tunable White is a technology developed by Normalit that offers luminaires providing healthy lighting that are connected to the DALI line and can be controlled via Normalink.

<sup>(2)</sup> DALI DT8 or DALI Device Type 8 is the DALI luminaire that enables the tunable white to be controlled via a single DALI address.

<sup>(3)</sup> INTELLIGENT WIRELESS is the technology developed by Normalux in accordance with the IEC 62386-104 Standard that enables wireless communication between emergency luminaires or exit signs that is compatible with this technology.

<sup>(4)</sup> Modbus/IP is a standard protocol that enables Normalink to be integrated in a supervision system (SCADA or BMS).



WIRELESS SYSTEM  
NORMALUX



## Main functions of Normalink

With Normalink, you can explore all of the lighting possibilities for a room, establishment or building, making it more human, efficient, practical and safe.



### Create Environments

Control Tunable White.



Group configuration.



- **Control each light point individually**, by DALI groups or even by virtual groups of luminaires from different DALI lines.
- **Group luminaires together and define scenarios** (light levels) in accordance with the needs of each room.
- Create time settings for the **fittings to turn on, turn off or create scenarios**.
- **Set the light level and even the colour temperature** of the luminaires with tunable white control. **NEW FEATURE!**
- **Simulation of circadian cycles** that enables healthy and comfortable environments to be created. **NEW FEATURE!**

## Integrate external elements

Normalink integration.

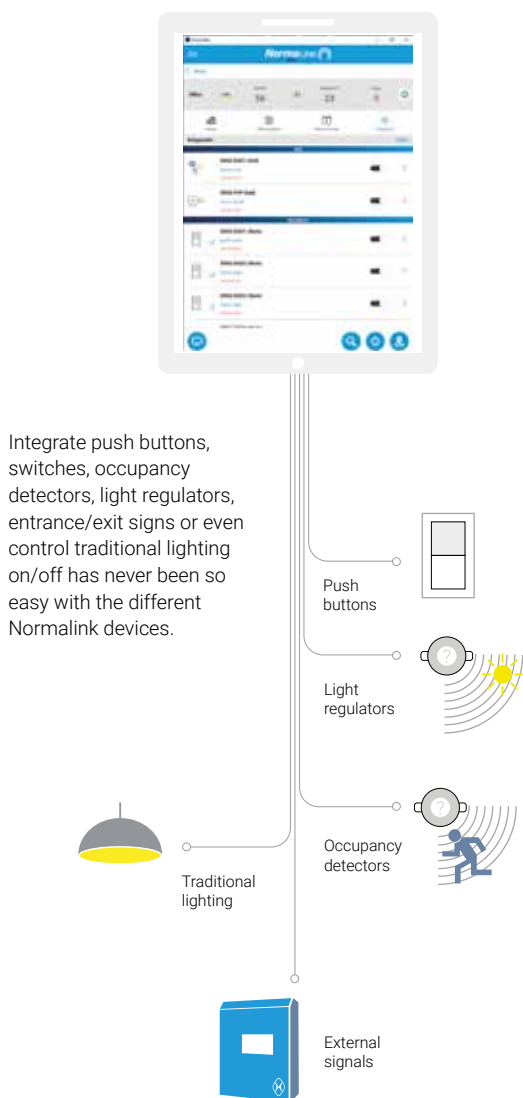

## Monitor safety lighting

Control del Emergency lighting.



Test configuration.



- **Monitor** the status of the emergency lighting fitting and exit signs **in real time**.
- **Detection and notification of any anomaly**. It also reports faults in the general lighting.
- **Automatic log**.
- Normalink is **compatible with C24i central battery systems**.
- **Compatible** with autonomous **SATI Addressable** emergency lighting (IDALING gateway required).
- Normalink BMS for **comprehensive monitoring**. **NEW FEATURE!**











Normalink BMS control software.



# The Normalink ecosystem

A system that you can trust

- **Simple DALI wiring, without polarity and isolated** (robust communication without any surprises).
- **Scalable system**, ideal for small, medium or large installations.
- **Quick and simple commissioning.**
- **Universal external elements** (light regulators, occupancy detectors, push buttons, external signals, etc.) are **directly connected to the DALI line via adapters** (without the need for a DALI address).

-  DALI-TCP/IP Gateway (Ref. IDNG-64)
-  TCP/IP master gateway (Ref. IDNG-MG)
-  Adapter for push buttons, occupancy detectors and light regulators (Ref. IDNG-EAD)
-  DALI Luminaire
-  SALUZ TW / DALI DT8 Luminaire
-  DALI Emergency Luminaire
-  Luminaire for C24i central battery systems
-  Self contained emergency intelligent block WIRELESS NORMALUX
-  Push buttons (Ref. IDNG-P4P)
-  Light regulators (Ref. ILSR110/ILSS110)
-  Central Battery System (Ref. C24i-300)



**DALI Line**  
2x1,5 mm<sup>2</sup>  
Max. 300 m

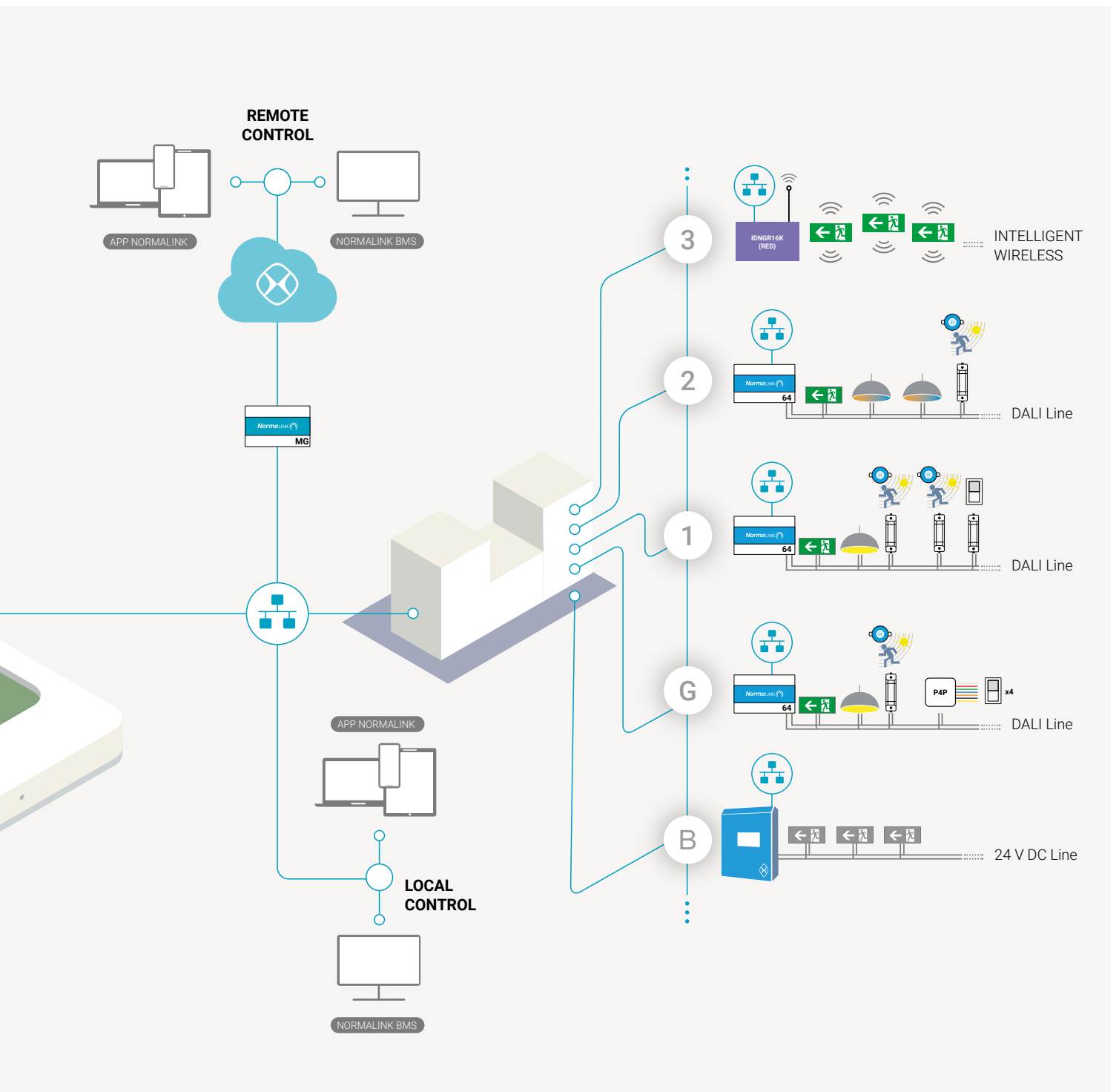

## Normalink TW

Now it is possible to control DALI DT8 and SALUZ Tunable White luminaires with Normalink and to create healthier and more comfortable environments.

- It is possible to **simulate circadian cycles** (up to 32) and modify them (intensity and colour temperature) by time blocks.
- **Push buttons, occupancy detectors and/or light regulators** which can also act on the programmed circadian cycles.
- **Control and configuration** from Normalink APP and Normalink BMS.
- In addition to the IDNG64 gateways in accordance with the number of DALI luminaires, this new function also requires an IDNG-MG gateway connected to the same local network which will act as the system's switchboard.

## Normalink and emergency lighting / exit signs

Normalink is a platform designed to control and monitor safety lighting.

- **Control and monitoring** of each of the self contained blocks of emergency lighting and exit signs.
- **Monitoring and control of the emergency luminaires** and/or luminaires connected to C24i central battery systems.
- **Programming of functional and autonomy tests** as per the standard EN 50172.
- **Anomalies warning.**
- **Interaction with other safety systems.**
- **Integration** in SCADA control systems using MODBUS/IP.
- **Programming of scenes and time settings for emergency lighting** that is functioning permanently.
- **Control of the light** source in maintained mode.
- **Simple DALI addressing** via Normalink code (check availability).

---

### Example

Example of the control of circadian cycles via the IDNG-P4P with capacity for four push buttons:

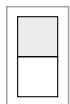

**Push button 1:**  
ON/OFF lighting and pre-defined circadian cycle.

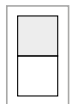

**Push button 2:**  
Regulation of the colour temperature.

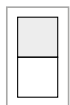

**Push button 3:**  
Regulation of the amount of light and the switching on/off of the luminaires.

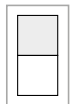

**Push button 4:**  
"Siesta" scene in which all of the luminaires are set to a colour temperature of 2700 °K and light intensity of 10%.



## Normalink BMS

Normalink BMS allows the monitoring from any computer connected to the same local network as the other Normalink elements. (Gateways with DALI luminaires, C24i central battery systems with emergency luminaires at 24 V DC, input- output modules,...). Remote monitoring is also possible thanks to Normalink Cloud

- **Monitor and control** general DALI lighting, self contained DALI emergency lighting and C24i central battery systems.
- **Connection to the local network or remotely** via Normalink Cloud.
- **Anomalies warning** (by type, quantity, time, etc.).
- **Notifications sent by e-mail.**
- **Customisation of reports.**
- **Test configuration** (functional and annual).
- **Performance of tests** (functional and annual).
- **Creation and control** of groups, scenes and timings.
- **Log of events** and tests.
- **Global vision of the building** with a fittings and anomalies counter.
- **Development module** for project creation.
- **Automatic recognition** of all the devices compatible with Normalink in the local network (gateways, i/o modules, central battery systems).
- **Multi-user system.**

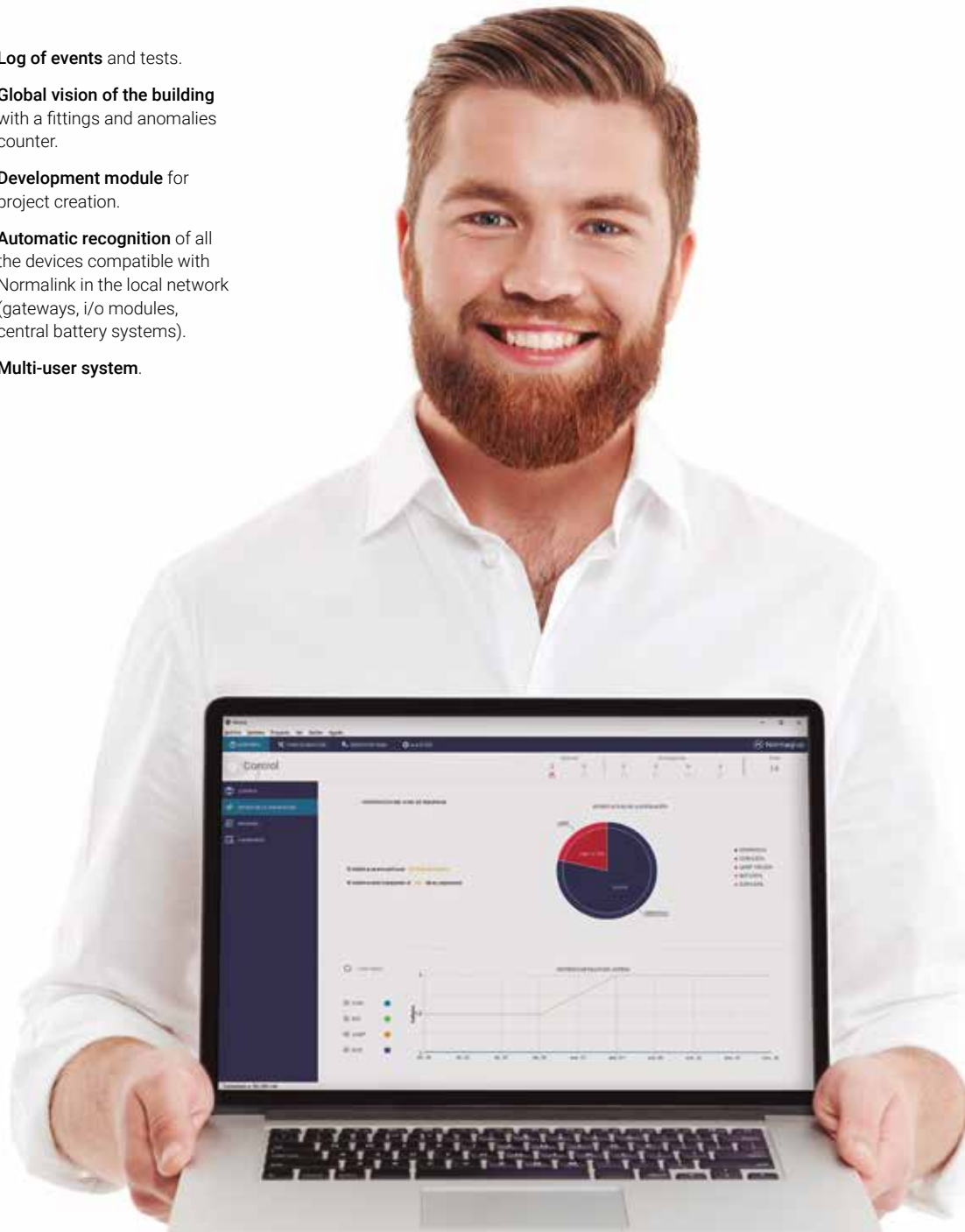



Normalink BMS takes pride on its two different modules: One for supervision / control and another one to develop from scratch and customizable.

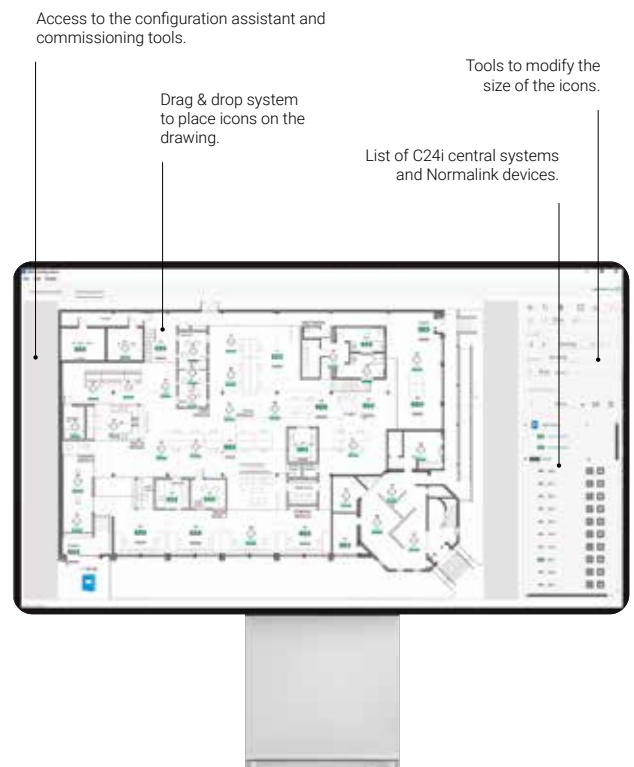
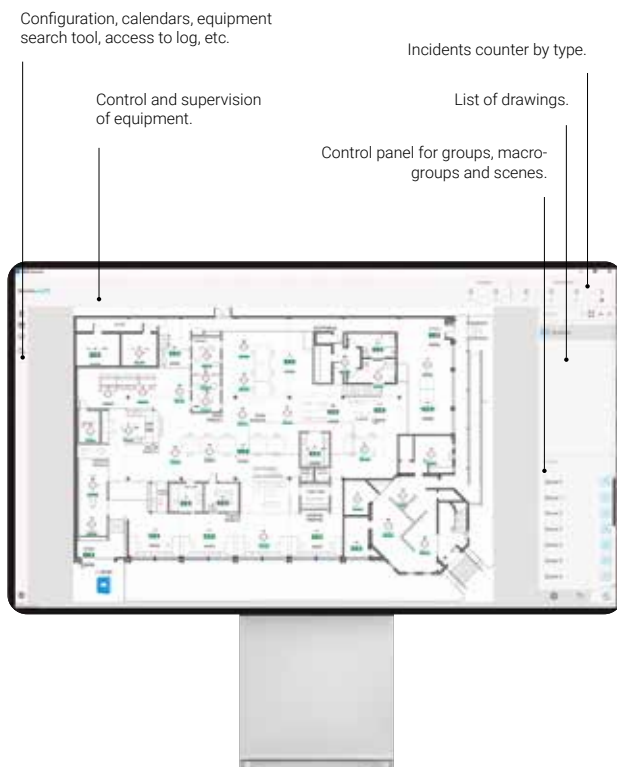

## Control module

- Browsing by drawings.
- Real time status.
- Identification of incidents by type (light source, battery, autonomy, communication).
- Filtering by type of incident.
- Control of groups, macro-groups and scenes.
- Individual control of each luminaire. Control of the maintained status (on, off and dim), remote control, performance of tests, etc.
- Reports management tool.
- Annual events calendar.
- Search tool for luminaires in the drawing.
- Notifications management tool.

## Development module

- Step-by-step configuration assistant. Simple and intuitive.
- Tools for centralised commissioning.
- Customised reports editor.
- Drag & drop system for project development.
- Modification of the size of icons according to the plan of the building.

## Normalink Devices

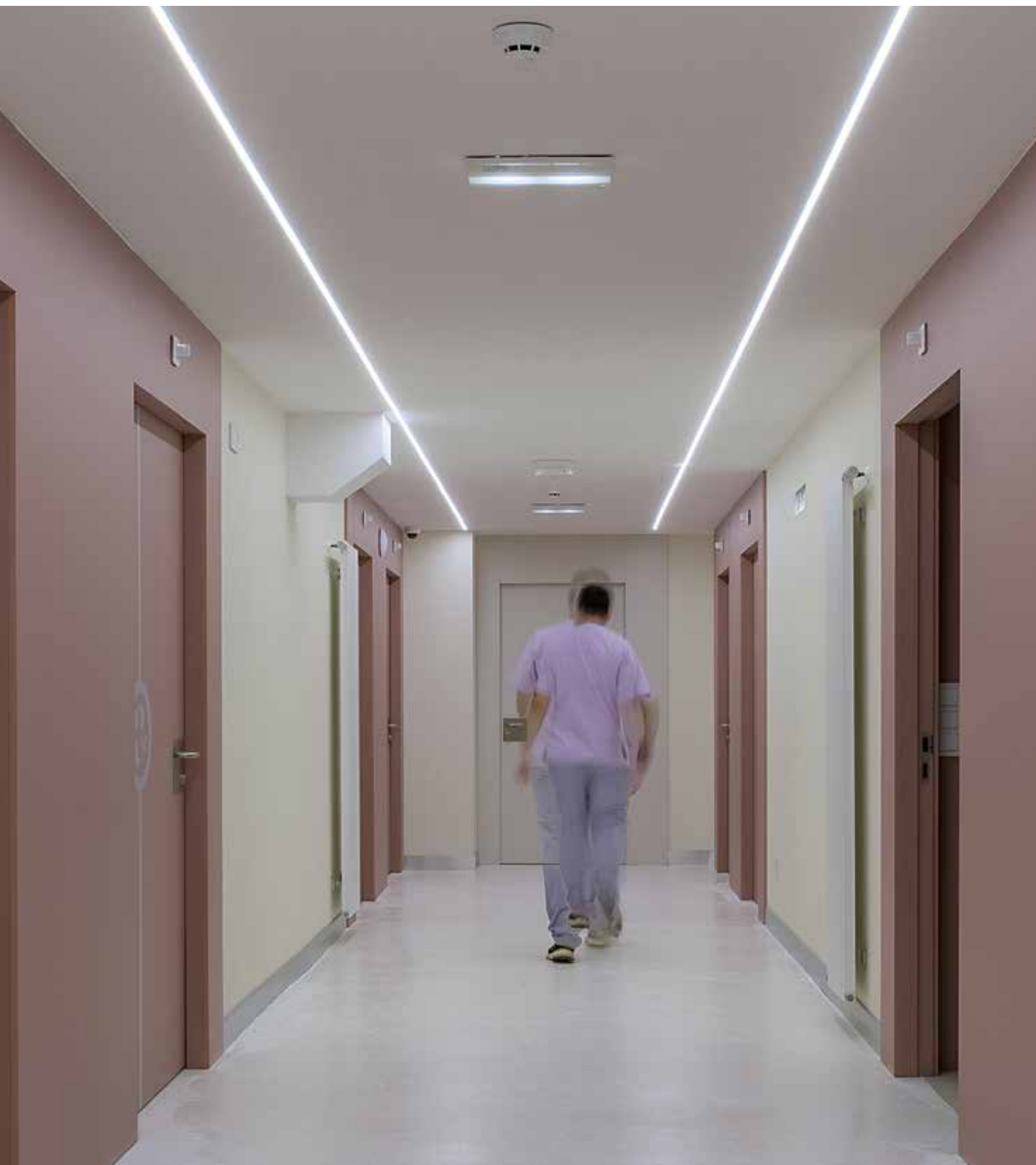

Photography: Natalia Michelena Photo. Architecture: Verónica Durán Sela

## IDNG-MG

**TCP/IP master gateway for the control of Normalink installations.** Configuration through the incorporated webserver. Once connected to the same local network as the rest of the Normalink devices, the Master gateway will take control of the installation allowing.



- Ethernet connection.
- Configure notifications.
- The installation to be controlled remotely thanks to the Normalink Cloud service.
- Comprehensive control of the installation thanks to the Normalink BMS software with drawings (included in the Gateway).
- Control the installation from external software with Modbus IP support.
- DIN Rail mounting (12 modules).
- Power Supply: 230V AC 50-60Hz from an UPS (Uninterrupted Power Supply).
- Dimensions: 210 x 90 x 60 mm.

## IDNG-EAD

**Adapter** to integrate non-DALI control devices, such as push buttons, occupancy detectors and light regulators, into the DALI line.

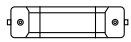

- It has a DALI connector, 0-10 V analogue input (non-isolated) and a digital input (230 V AC).
- Automatic detection and configuration from the Normalink app.
- Powered via the DALI bus.
- Does not use a DALI address.
- Identification via Normalink code.
- Dimensions: 215 x 33.5 x 30 mm.

## IDNG64

**DALI-TCP/IP gateway for control via Normalink** of up to 64 general lighting and/or emergency lighting luminaires as per the DALI (Digital Addressable Lighting Interface) Standard.



- Dimensions: 105 x 90 x 60 mm.
- Ethernet connection.
- DIN Rail mounting (6 modules).
- Incorporates an internal power supply to power the DALI line and a CR2032 battery to avoid losing information.
- Power Supply: 230V AC 50-60Hz from an UPS (Uninterrupted Power Supply).
- Additionally, this device enables the connection, via the DALI line, of up to 16 devices with the Normalink code (Ref. IDNG-EAD and IDNG-P4P).

## IDNG-P4P

**Interface** for the connection of four push buttons or a switch (potential-free) to a DALI line and its integration in the Normalink system.



- Connection to the DALI line.
- Four inputs or channels (IN0, IN1, IN2 and IN3) and a shared terminal.
- Powered by section wires of 0.5 mm<sup>2</sup> and 200 mm long.
- Terminals IN1, IN2, IN3 and IN4 cannot be extended using an extra wire.
- Automatic detection and configuration from the Normalink app.
- Powered from the DALI bus.
- Does not use a DALI address.
- Identification via Normalink code.
- Dimensions 50 x 50 mm.

## Normalink Devices

### ILSR110

1/10V DC **closed loop constant light regulator** for connection to Normalink IDNG-EAD adapter.



- Mounted in false ceiling. Incorporates a movement sensor (PIR) allowing the activation of the lighting when people are present, if required.
- Power Supply: 230 V AC 50 Hz.
- Brightness level: 100~1000 lux.
- Connection Time: 10-30 min.
- IP 20 as per UNE 20324.
- Operating temperature: 0°C to 40°C.
- Movement detection range: 360°/day. 7 m at a height of 2.5 m.
- Diameter: 80 mm.
- Controller dimensions: 107x53x34 mm.
- Manufactured as per UNE EN 60730 Standard.

### ILSS110

1/10V DC **closed loop constant light regulator** for connection to Normalink IDNG-EAD adapter.



- Surface ceiling mounted. Incorporates a movement sensor (PIR), allowing the activation of the lighting when people are present, if required.
- Power Supply: 230 V AC 50 Hz.
- Brightness level: 100~1000 lux.
- Connection Time: 10-30 min.
- IP 20 as per UNE 20324.
- Operating temperature: 0°C to 40°C.
- Movement detection range: 360°/day. 7 m at a height of 2.5 m.
- Diameter: 118.5 mm.
- Height: 45 mm.
- Manufactured as per UNE EN 60730 Standard.



## IDNG-10ES

**Input / output module compatible with the Normalink system.** Allows the direct integration of external input / output elements to Normalink (not through DALI).



- Dimensions: 105 x 90 x 60 mm.
- 10 terminals that can be programmed as inputs or outputs.
- One relay output.
- Ethernet connection.
- Web server for network configuration.
- Potential-free inputs for the connection of push buttons, switches or signals.
- 24v outputs for connecting relays, solid state contactors or external devices (PLCs, switchboards or others). Maximum current output 10mA.
- Identification via Normalink code.
- DIN Rail mounting (6 modules).
- Power Supply: 230V AC 50-60Hz from an UPS (Uninterrupted Power Supply).

## Sales Terms and Conditions

- Consult RRP prices of Normalink devices.
- The sale of the Normalink system, its devices and the provision of the commissioning service (Ref. ISS) is subject to the purchase of Normalit technical lighting and/or Normalux emergency lighting.



Lighting and its durability depend not only on the features of the equipment and professional planning of the installation but also on the tuning and cleaning of all its elements.

Normagrup tests all its solutions in the laboratory for optimal durability and maintenance processes.



# The maintenance factor

The maintenance factor (MF) establishes the relationship between the average illuminance or illumination level after a period of use and the initial illuminance under the same conditions. Several factors are used to calculate this value.

---

## The formula

$$MF = (LLMF \times LSF) \times LMF \times RMF$$

---

## The factors

### Lamp Lumen Maintenance Factor: LLMF

Measures a time-dependent decrease in the light output of the lamp as a consequence of use. Identifies the incidence of lamp ageing with respect to initial values.

### Light Survival Factor (LSF)

Establishes the life of the light based on the average durability values in the market. The maintenance plan establishes the appropriate frequency of replacement.

### Lighting Fixture Maintenance Factor (LMF)

Indicates the light loss caused by deterioration or dirt on luminaires, affecting the lighting of a space. To establish a maintenance plan, evaluate the deterioration of materials or the obstruction of the light by factors such as dirt.

### Room (Surface) Maintenance Factor (RMF)

Indicates a time-dependent decrease (due to dirt) of the reflection values of room surfaces. As well as the room and the type of installation, it considers the frequency and type of cleaning of perimeter areas to maintain the initial conditions.

## LLMF & LSF

valores Lx	Z hours		Service life in 1000 h																				
			1	5	10	15	20	25	30	35	40	45	50	55	60	65	70	75	80	85	90	95	100
L80 B10	50.000	LLMF	1,00	0,99	0,97	0,96	0,94	0,83	0,91	0,90	0,88	0,87	0,85	0,84	0,82	0,81	0,79	0,78	0,76	0,75	0,73	0,72	0,70
		LSF	1,00	1,00	1,00	1,00	1,00	1,00	1,00	1,00	1,00	1,00	1,00	1,00	1,00	0,99	0,99	0,99	0,99	0,99	0,99	0,99	0,99
L80 B10	100.000	LLMF	1,00	0,99	0,99	0,98	0,97	0,96	0,96	0,95	0,94	0,93	0,93	0,92	0,91	0,90	0,89	0,88	0,87	0,87	0,86	0,85	
		LSF	1,00	1,00	1,00	1,00	1,00	1,00	1,00	1,00	1,00	1,00	1,00	1,00	1,00	1,00	1,00	1,00	1,00	1,00	1,00	1,00	1,00
L80 B50	50.000	LLMF	1,00	0,98	0,96	0,94	0,92	0,90	0,88	0,86	0,84	0,82	0,80	0,78	0,76	0,74	0,72	0,70	0,68	0,66	0,64	0,62	0,60
		LSF	1,00	1,00	1,00	1,00	1,00	1,00	1,00	1,00	1,00	0,99	0,99	0,99	0,99	0,99	0,99	0,99	0,99	0,99	0,99	0,98	0,98
L80 B50	100.000	LLMF	1,00	0,99	0,98	0,97	0,96	0,95	0,94	0,93	0,92	0,91	0,90	0,89	0,88	0,87	0,86	0,85	0,84	0,83	0,82	0,81	0,80
		LSF	1,00	1,00	1,00	1,00	1,00	1,00	1,00	1,00	1,00	1,00	1,00	1,00	0,99	0,99	0,99	0,99	0,99	0,99	0,99	0,99	0,99
L70 B10	50.000	LLMF	0,99	0,97	0,95	0,92	0,90	0,87	0,84	0,82	0,79	0,77	0,74	0,71	0,69	0,66	0,64	0,61	0,58	0,56	0,53	0,51	0,48
		LSF	1,00	1,00	1,00	1,00	1,00	1,00	0,99	0,99	0,99	0,99	0,99	0,99	0,99	0,99	0,99	0,99	0,99	0,99	0,99	0,98	0,98
L70 B10	100.000	LLMF	1,00	0,99	0,97	0,96	0,95	0,94	0,92	0,91	0,90	0,88	0,87	0,86	0,84	0,83	0,82	0,81	0,79	0,78	0,77	0,75	0,74
		LSF	1,00	1,00	1,00	1,00	1,00	1,00	1,00	1,00	1,00	1,00	1,00	1,00	1,00	1,00	1,00	0,99	0,99	0,99	0,99	0,99	0,99
L70 B50	50.000	LLMF	0,99	0,97	0,94	0,91	0,88	0,85	0,82	0,79	0,76	0,73	0,70	0,67	0,64	0,61	0,58	0,55	0,52	0,49	0,46	0,43	0,40
		LSF	1,00	1,00	1,00	1,00	1,00	1,00	0,99	0,99	0,99	0,99	0,99	0,99	0,99	0,99	0,99	0,99	0,99	0,98	0,98	0,98	0,98
L70 B50	100.000	LLMF	1,00	0,99	0,97	0,96	0,94	0,93	0,91	0,90	0,88	0,87	0,85	0,84	0,82	0,81	0,79	0,78	0,76	0,75	0,73	0,72	0,70
		LSF	1,00	1,00	1,00	1,00	1,00	1,00	1,00	1,00	1,00	1,00	0,99	0,99	0,99	0,99	0,99	0,99	0,99	0,99	0,99	0,99	0,99
L70 B50	35.000	LLMF	0,99	0,96	0,91	0,87	0,83	0,79	0,74	0,70	0,66	0,61	0,57	0,53	0,49	0,44	0,40	0,36	0,31	0,27	0,23	0,19	0,14
		LSF	1,00	1,00	1,00	0,99	0,98	0,97	0,96	0,94	0,90	0,86	0,82	0,77	0,72	0,67	0,62	0,57	0,52	0,47	0,42	0,37	0,30
L50 B50	50.000	LLMF	0,99	0,95	0,90	0,85	0,80	0,75	0,70	0,65	0,60	0,55	0,50	0,45	0,40	0,35	0,30	0,25	0,20	0,15	0,10	0,05	0,00
		LSF	1,00	1,00	1,00	0,99	0,99	0,99	0,99	0,99	0,98	0,98	0,98	0,98	0,98	0,97	0,95	0,80	0,80	0,60	0,40	0,20	0,00
L50 B50	100.000	LLMF	1,00	0,98	0,95	0,93	0,90	0,88	0,85	0,83	0,80	0,78	0,75	0,73	0,70	0,68	0,65	0,63	0,60	0,58	0,55	0,53	0,50
		LSF	1,00	1,00	1,00	1,00	1,00	1,00	0,99	0,99	0,99	0,99	0,99	0,99	0,98	0,98	0,98	0,98	0,98	0,97	0,97	0,97	0,97
L50 B50	35.000	LLMF	0,99	0,93	0,86	0,79	0,71	0,64	0,57	0,50	0,43	0,36	0,29	0,21	0,14	0,07	0,00	0,00	0,00	0,00	0,00	0,00	0,00
		LSF	1,00	1,00	1,00	0,99	0,98	0,97	0,96	0,90	0,80	0,70	0,60	0,50	0,35	0,20	0,00	0,00	0,00	0,00	0,00	0,00	0,00

## LMF

CLEANING FREQUENCY	1 year				2 years				3 years			
	Very clean	Clean	Normal	Dirty	Very clean	Clean	Normal	Dirty	Very clean	Clean	Normal	Dirty
Open luminaires	0,96	0,93	0,89	0,83	0,93	0,89	0,84	0,78	0,90	0,85	0,79	0,73
Closed luminaires	0,94	0,88	0,82	0,77	0,89	0,83	0,77	0,71	0,85	0,79	0,73	0,65
Watertight luminaires	0,98	0,94	0,90	0,86	0,95	0,91	0,86	0,81	0,94	0,90	0,84	0,79
Indirect luminaires	0,91	0,86	0,81	0,74	0,86	0,77	0,66	0,57	0,80	0,70	0,55	0,45

## RMF

CLEANING FREQUENCY	1 year				2 years				3 years			
	Very clean	Clean	Normal	Dirty	Very clean	Clean	Normal	Dirty	Very clean	Clean	Normal	Dirty
Direct emission	0,99	0,98	0,96	0,95	0,97	0,96	0,95	0,94	0,97	0,96	0,95	0,94
Direct/indirect emission	0,96	0,92	0,88	0,85	0,93	0,89	0,85	0,81	0,90	0,86	0,82	0,78
Indirect emission	0,94	0,88	0,82	0,77	0,91	0,84	0,77	0,70	0,84	0,78	0,72	0,64

# Lighting technique



# Basic concepts

## Colour temperature

The colour emitted by a light source in comparison with the light that a black body heated at a specific temperature would emit. For this reason, this colour temperature is expressed in kelvin, in spite of not reflecting specifically a temperature. There are basically three groups:

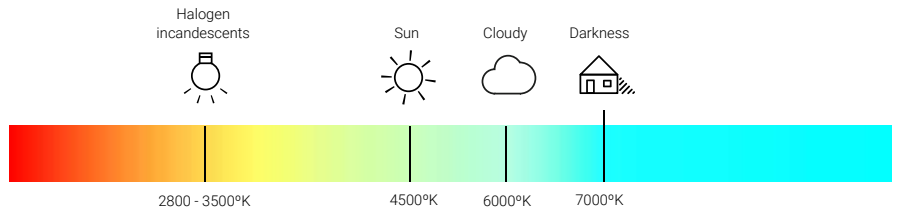

### Warm light

3500°K or lower temperature colour.

It is equivalent to the light produced by incandescent and halogen lamps in the past. It is recommendable for retail stores, fruit shops, bakeries, groceries and butcheries (in these two latests it is even more common a light in a pink tone). For domestic lighting it is recommended to use this type of light in rooms such as the living room or the bedrooms, places for **rest and relax.**

### Neutral light

Temperature ranges from 3800°K and 4500°K

According to the experts this is the most natural light. It can be installed in any environment not requiring any special tone that the other two categories could provide.

### Cold light

Colour temperatures above 5000°K

It is equivalent to the light in a very sunny or cloudy day. One of the advantages of the cold light is the higher lumen output, which creates a perception of higher luminosity. This type of light is recommended for fish markets and jeweleries. For homes, it is very common to find it in kitchens and toilets. However the experts in make up always recommend cold lights as they offer an advantage, which is that they provide a better chromatic range.

## Expectancy del led

The expectation of useful life of the LED has been defined by an indicator such as the one shown at the right of this page. In the mentioned example, at 60,000h, 90% of the luminaires will have an output equal to or greater than 70% of the nominal value.

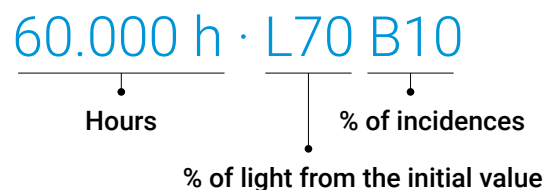

## Chromatic reproduction index

Capacity of a light source to reproduce accurately the colours that it illuminates.

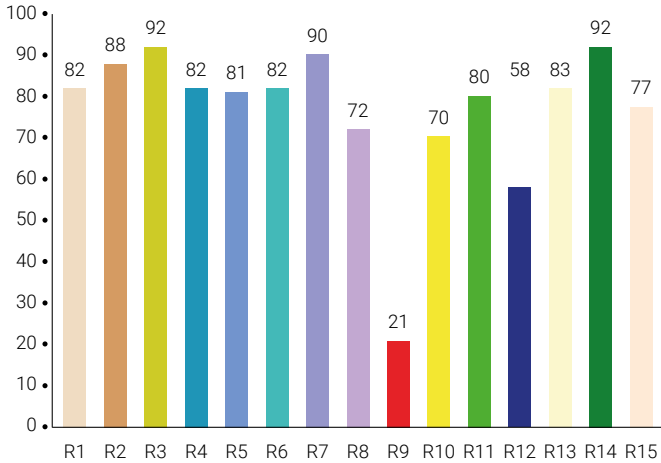

Scale from 0 to 100.  
15 values referred in a pattern.

## Kruithof Curves

Relation illuminance levels [lux]  
colour temperature [°K]

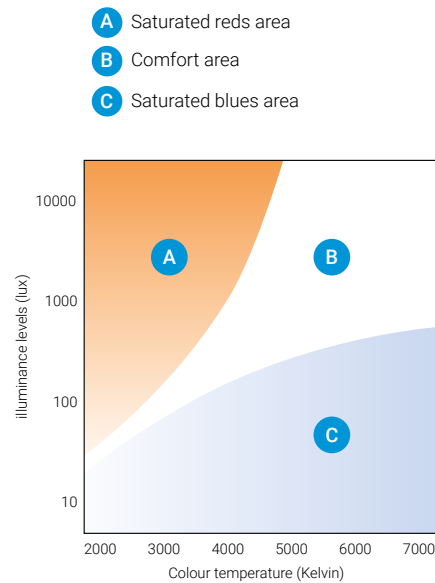

**B Zone**  
Ideal temperature according to illuminance.  
Comfort area.

## Control of the light temperature

LEDs from the same batch can present variations in intensity and/or in colour.

The chromatic homogeneity of the leds is measured through a series of ellipses (MacAdam ellipses).

The less the size of the ellipse is, the less the chromatic deviation.

The deviation is measured in SDCM (Standard Deviation of Colour Matching).

- **1 SDCM:** There are no colour differences.
- **2-4 SDCM:** There is hardly no visible difference.
- **5 SDCM or more:** The different is easily perceptible.

Normagrup works  
is 3-4 MacAdam Ellipses.

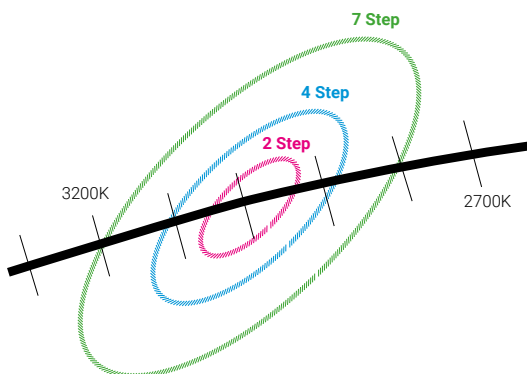

## Light performance $\eta$

It indicates the real flux. Defines the luminic efficiency of a luminaire.

ELIT (ref. EL23)

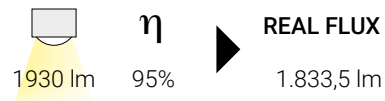

HAT (ref. EH23)

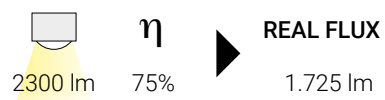

Lower lumen output, better efficiency

## UGR (Unified Glare Rating)

It is the rate that indicates the level of glaring that the human eye is undergoing. There are several factors that affect this rate:

- The technical and constructive features of the luminaire itself.
- The installation of the luminaire (height and position with regard to the observer).
- The reflections of the surrounding materials (floor, walls, ceiling...).

The International Commission of Lighting (known as CIE, Commission Internationale de l'éclairage) has determined the values of compulsory fulfillment depending on the area of activity through the regulation EN12464-1:2011.

The design process is critical when defining the UGR rate that will finally accomplish a luminaire. **Hiding the point of light, avoiding opal glasses or using microprismatic diffusers helps to reduce the glare of the luminaire.**



## Photobiological safety

EN 62471 norm about photobiological safety establishes a series of criteria to analyze if a lamp or luminaire can cause damages to the eyes or the skin.

There are four level of risks according to this norm.

GROUP OF RISK

RG0	Risk free
RG1*	Low risk
RG2	Moderate risk
RG3	Hight risk

\*Time under 3 h.

## Flickering

Also known as **periodical blinking of the light source of a luminaire** (stroboscopic effect), it is present in almost all the artificial light sources and is caused by the looping out of the output current in the LED driver.

How much the flickering can affect the user is calculated as below:

- A flickering under 15% prevents dizziness, nausea and headaches.
- Under 8% this flickering is not considered to be harmful (according to IEEESA-1789-2015).



## Light uniformity

Sites must have a proper lighting that guarantees the minimum values regulated by the norm in any

point; **variations of the lighting levels in a room cause negative effects on the users.**



# Guide for regulation control

## Analog regulation 1-10V \*

### Potentiometer functioning:

Press the potentiometer to turn on or off the luminaire.

Move the wheel to increase or reduce the luminic intensity.

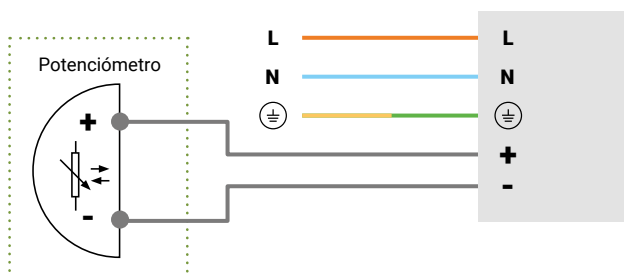

## Digital regulation with push button\*

### Push button functioning:

A short press turns the light on or off.

A continuous press adjust the lumen output..

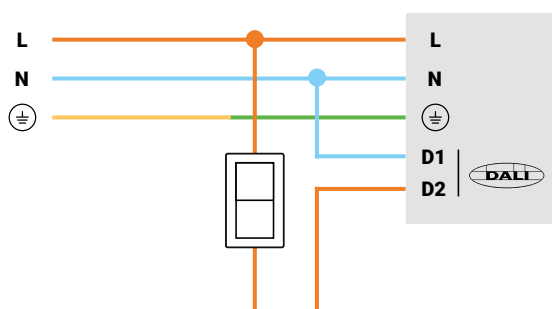

## Digital DALI regulation

### DALI Network:

DALI devices are connected with a single bus wire and are identified with unique addresses, so they can be assigned to groups or scenes with a simple programation.

DALI protocol features:

- Maximum number of fittings per line: 64
- Maximum distance: 300 meters
- 2 x 1,5 mm<sup>2</sup> wire
- No polarity
- Star or tree connections are allowed.
- Closed loops are not allowed.
- Maximum number of DALI groups (per line): 16
- Maximum number of DALI scenes (per line) : 16

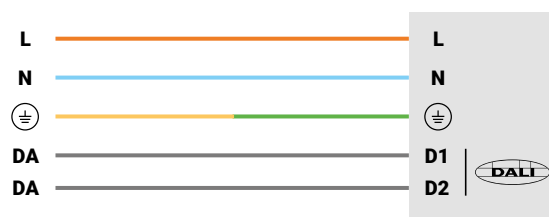

\*Regulation option not available on Hat Micro, Hat S, BLOK and BLOK R families.





A series of horizontal dotted lines spanning the width of the page, providing a guide for handwriting practice.



# NORMALIT

Technical and architectural lighting  
[normalit.com](http://normalit.com)

## This catalogue helps to care for our planet

Less is more. We use less water, less paper and 100% recycled materials to create a more sustainable catalogue, reducing CO<sub>2</sub> emissions in each product.

## Environmentally Light!

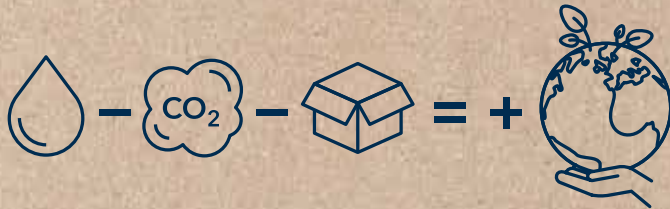

**100%**

*Entirely designed and  
manufactured in Spain*

### Headquarters

Parque Tecnológico de Asturias. C/ Ablanal, 1  
33428 Llanera (Asturias). España / Spain  
[normagrup.com](http://normagrup.com)

### Normagrup UK

Black Country House  
Rounds Green Road  
Oldbury  
B69 2DG

### Normagrup Netherlands

Korte Huifakkerstraat 18  
4815 PS Breda, The Netherlands

### Normagrup France

27 Rue Edouard Lang  
76600 Le Havre  
France

### Normagrup Iluminación de México

Calle Pedro Moreno 1786  
Reforma, Reforma San Mateo Atenco  
C.P. 52120 México



**Normagrup**