

Nassel



Premio IDEPA
al mejor proyecto innovador

NASSEL es un modelo innovador de luminaria LED especialmente indicado para techos modulares. Transmite una luz directa y confortable gracias a la combinación de dos difusores (uno microprismático y otro opalizado) y un reflector en plástico técnico de alta reflexión.

NASSEL S es la versión de esta pantalla para instalación adosada a techo.

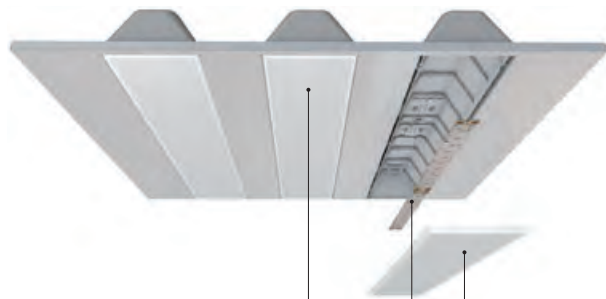
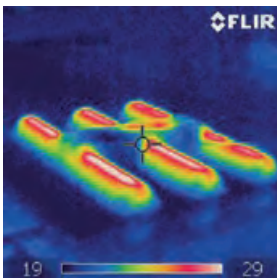

- 1 Estructura ligera, peso reducido
- 2 Placa Led intercambiable, estándar Zhaga
- 3 Difusor Microprismático, optimiza el flujo luminoso (UGR<19)

1 2 3

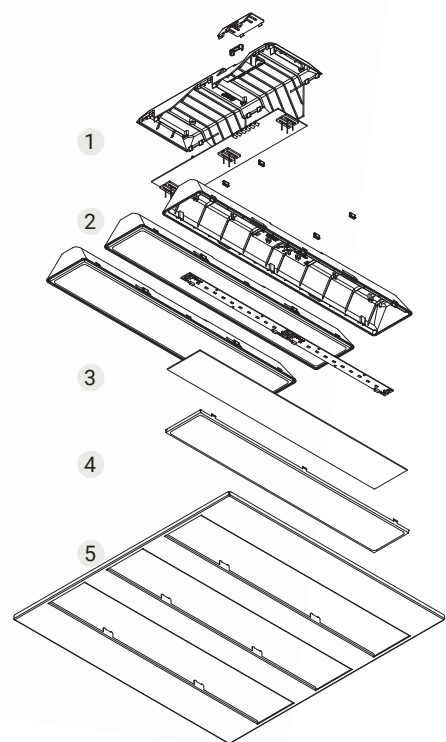

- 1 Bornero de conexión
- 2 Cuerpo disipador
- 3 Difusor intermedio
- 4 Difusor Microprismático
- 5 Estructura

	Nassel	Nassel S
Instalación	Empotrado a techo	Adosado a techo Suspendido a techo
Difusor	☒	☒
Fuente de luz	LED	LED
Seguridad fotobiológica	0	0
UGR	16	16
CRI	>80	>80
Elipses de Macadam	3	3
Rango ángulos de apertura	73	73
Rango potencia (W)	36-48	24-48
Temperatura de color (°K)	3000 4000	3000 4000
Rango lumínico	3400-7400	3400-7400
Factor de potencia	0,95	0,95
Rendimiento (%)	80,3	80,3
Expectativa	60000 h L70B10	60000 h L70B10
Opción DALI	✓	✓
Funcionamiento continuado 24h	✓	✓
IP	20-44	30
Clase	II	II
Escotadura ideal (mm)	600x600 1200x300 1200x600	

☒ Difusor microprismático

! Otros valores CRI a consultar

! Solicite siempre las características técnicas de todos los productos de iluminación.

Nassel



IP
20-44

CRI
>80

UGR
16

73°

Expectativa
60000 h.
L70B10

Rendimiento (%)
80,3

Seguridad fotobiológica

RG0	0 Exento de riesgo
RG1*	Bajo riesgo
RG2	Riesgo moderado
RG3	Riesgo alto

*Tiempo inferior a 3 h.

○ RAL9016

Instalación sobre techos modulares

NS2

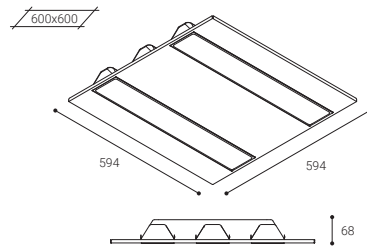

NS3

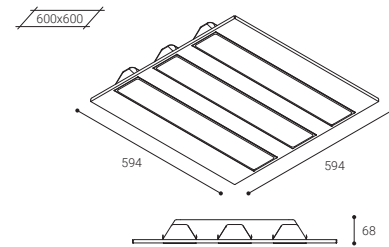

NS4

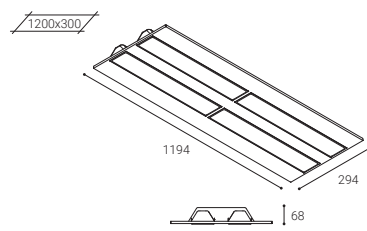

NS5

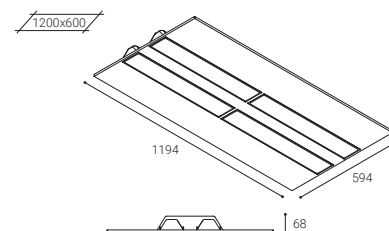

Difusor microprismático

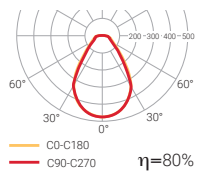

	W	K	LUMEN	COLOR	
NS23B	1x24W	3000	3400 lm	○	2,9
NS24B	1x24W	4000	3700 lm	○	2,9
NS33B	1x36W	3000	5100 lm	○	2,9
NS34B	1x36W	4000	5550 lm	○	2,9
NS43B	1x48W	3000	6800 lm	○	2,9
NS44B	1x48W	4000	7400 lm	○	2,9
NS53B	1x48W	3000	6800 lm	○	7,0
NS54B	1x48W	4000	7400 lm	○	7,0



Compatible con **NormaLINK**

	W	K	LUMEN	COLOR	
NS23DB	1x24W	3000	3400 lm	○	2,9
NS24DB	1x24W	4000	3700 lm	○	2,9
NS33DB	1x36W	3000	5100 lm	○	2,9
NS34DB	1x36W	4000	5550 lm	○	2,9
NS43DB	1x48W	3000	6800 lm	○	2,9
NS44DB	1x48W	4000	7400 lm	○	2,9
NS53DB	1x48W	3000	6800 lm	○	7,0
NS54DB	1x48W	4000	7400 lm	○	7,0

POSIBILIDAD DE EJECUCIONES ESPECIALES

Nassel Escayola

NUMERO DE EQUIPOS PARA UNA INSTALACIÓN TIPO

NS34B

	200 lx	300 lx	500 lx
50 m ²	3	4	6
100 m ²	4	8	10
150 m ²	6	10	15
200 m ²	6	12	20

Se ha estimado una altura de 2,8 m para el cálculo.



Instalación sobre techos de escayola

NM3

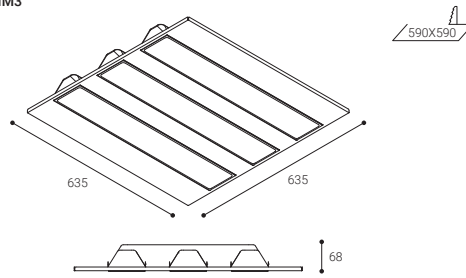

NM4

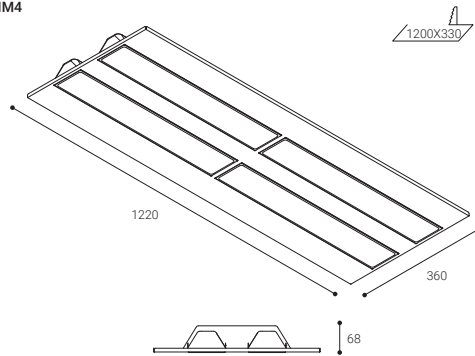

○ RAL9016

	W	K	LUMEN	COLOR	
NM33B	1x36W	3000	5100 lm	○	2,9
NM34B	1x36W	4000	5550 lm	○	2,9
NM43B	1x48W	3000	6800 lm	○	2,9
NM44B	1x48W	4000	7400 lm	○	2,9



Compatible con **NormaLINK**

	W	K	LUMEN	COLOR	
NM33DB	1x36W	3000	5100 lm	○	2,9
NM34DB	1x36W	4000	5550 lm	○	2,9
NM43DB	1x48W	3000	6800 lm	○	2,9
NM44DB	1x48W	4000	7400 lm	○	2,9

Nassel S



Adosado a techo



IP 30

CRI >80

UGR 16

73°

Expectativa
60000 h.
L70B10

Rendimiento (%)
80,3

Seguridad fotobiológica

RG0	0 Exento de riesgo
RG1*	Bajo riesgo
RG2	Riesgo moderado
RG3	Riesgo alto

*Tiempo inferior a 3 h.

NA2

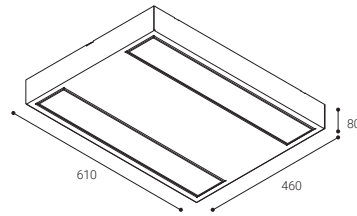

NA3

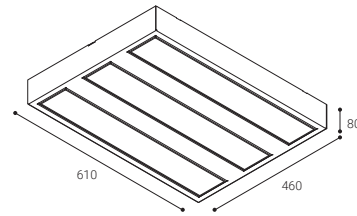

NA4

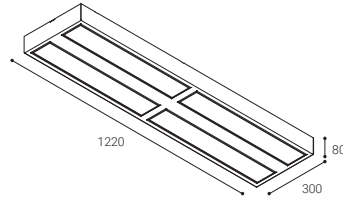

○ RAL9016

Difusor microprismático

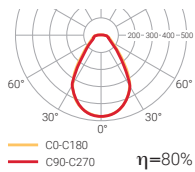

	W	K	LUMEN	COLOR	
NA23B	1x24W	3000	3400 lm	○	4,8
NA24B	1x24W	4000	3700 lm	○	4,8
NA33B	1x36W	3000	5100 lm	○	4,8
NA34B	1x36W	4000	5550 lm	○	4,8
NA43B	1x48W	3000	6800 lm	○	4,8
NA44B	1x48W	4000	7400 lm	○	4,8



Compatible con **NormaLINK**

	W	K	LUMEN	COLOR	
NA23DB	1x24W	3000	3400 lm	○	4,8
NA24DB	1x24W	4000	3700 lm	○	4,8
NA33DB	1x36W	3000	5100 lm	○	4,8
NA34DB	1x36W	4000	5550 lm	○	4,8
NA43DB	1x48W	3000	6800 lm	○	4,8
NA44DB	1x48W	4000	7400 lm	○	4,8

Nassel S



IP 20

CRI >80

UGR 16

73°

Expectativa
60000 h.
L70B10

Rendimiento (%)
80,3

Seguridad fotobiológica

RG0	0 Exento de riesgo
RG1*	Bajo riesgo
RG2	Riesgo moderado
RG3	Riesgo alto

*Tiempo inferior a 3 h.

NAS2

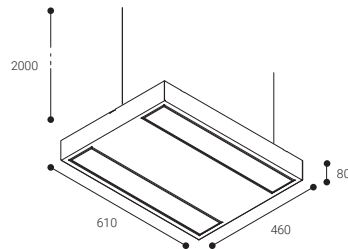

NAS3

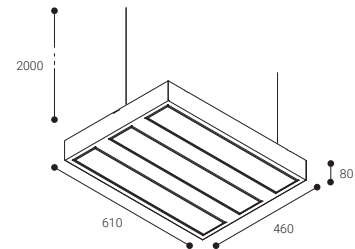

NAS4

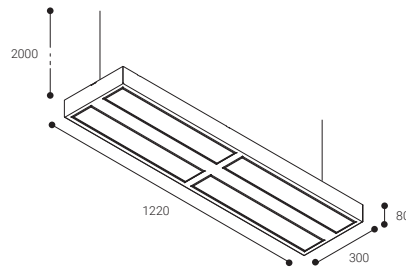

○ RAL9016

Difusor microprismático

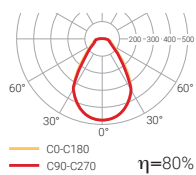

	W	K	LUMEN	COLOR	
NAS23B	1x24W	3000	3400 lm	○	4,8
NAS24B	1x24W	4000	3700 lm	○	4,8
NAS33B	1x36W	3000	5100 lm	○	4,8
NAS34B	1x36W	4000	5550 lm	○	4,8
NAS43B	1x48W	3000	6800 lm	○	4,8
NAS44B	1x48W	4000	7400 lm	○	4,8



Compatible con **NormaLINK**

	W	K	LUMEN	COLOR	
NAS23DB	1x24W	3000	3400 lm	○	4,8
NAS24DB	1x24W	4000	3700 lm	○	4,8
NAS33DB	1x36W	3000	5100 lm	○	4,8
NAS34DB	1x36W	4000	5550 lm	○	4,8
NAS43DB	1x48W	3000	6800 lm	○	4,8
NAS44DB	1x48W	4000	7400 lm	○	4,8



POSIBILIDAD DE EJECUCIONES ESPECIALES