



Elit

ELIT is the range of high added value recessed downlights by NormaLit. Their design, their features and their wide range make them the ideal downlight for any type of project.

ELIT is the perfect balance between design and technology. Its aluminium body is specifically designed to ensure the temperature of the LED is at an optimum and to achieve the best efficiency and durability. Its distinctive reflector made of technical polycarbonate creates a high quality, uniform light without any spots.

	Elit	Elit Max
Installation	Ceiling recessed mounted	Ceiling recessed mounted
Diffuser	○ ● ● ● ●	○ ● ● ● ●
Light source	LED	LED
Photobiological safety	1	1
UGR	19	19
CRI	>80	>80
MacAdam ellipse	3	3
Beam angle range	92-99	95-99
Power range (W)	11,8-54,6	17,4-54,6
Colour temperature (°K)	3000 4000	3000 4000
Light range	1930-8450	2650-8450
Power factor	0,95	0,95
Efficiency (%)	95,4	95,4
Expectancy	60000 h L70B10	60000 h L70B10
DALI Option	✓	✓
Continuous function 24h	✓	✓
IP	20-54	20-54
Class	II	II
Ideal cut out (mm)	218	245

○ Without diffuser ● Opal diffuser ● Transparent diffuser ● Wallwasher diffuser

Now
up to 8450 lm

Five versions
five diameters

Diameters

Circular cut

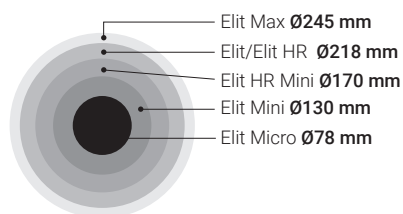

Elit HR	Elit HR Mini	Elit Mini	Elit Micro
Ceiling recessed mounted	Ceiling recessed mounted	Ceiling recessed mounted	Ceiling recessed mounted
○●○	○●○	○●○	○●○
LED	LED	LED	LED
1	1	1	1
19	19	19	19
>80	>80	>80	>80
3	3	4	4
92-97	92-97	90-96	88-94
11,8-54,6	11,8-54,6	14	6,4
3000 4000	3000 4000	3000 4000	3000 4000
1930-8450	1930-8450	1350-1490	760-885
0,95	0,95	0,95	0,5
95	95	97,6	92,9
60000 h L70B10	60000 h L70B10	60000 h L70B10	60000 h L70B10
✓	✓	✓	✓
✓	✓	✓	✓
20-54	20-54	20-54	20-54
II	II	II	II
218	170	130	78

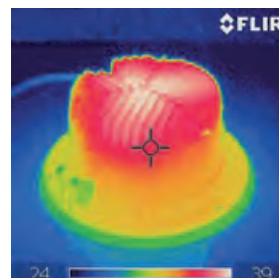

! Please, ask for the technical datasheets of all the luminaires.

! For other CRI values, please contact us.

Elit



Ceiling recessed mounted



IP **20-54** With opal diffuser/
transparent

CRI **>80** UGR **19** **92-99°**

Expectancy **60000 h.** Efficiency (%) **95,4**
L70B10

Photobiological safety

RG0	Risk free
RG1*	1 Low risk
RG2	Moderate risk
RG3	High risk

*Time under 3 h.

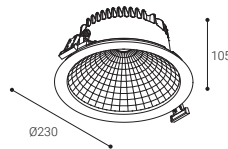

Minimum ceiling installation height **155**

Diameter range **Ø214-225**

Ideal cut out **Ø218**
Circular cut

- RAL9016
- RAL7001
- RAL9005

Without diffuser

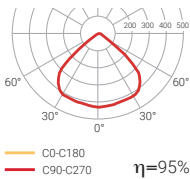

Transparent diffuser

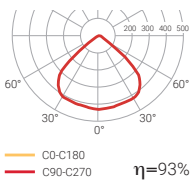

Opal diffuser

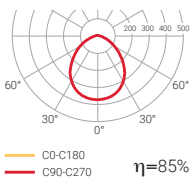

Wallwasher diffuser

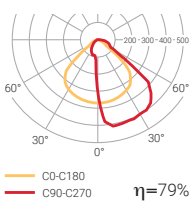

	W	K	LUMEN	COLOUR	η _{sp}
EL23B	1x11,8W	3000	1930 lm	○	0,8
EL23G	1x11,8W	3000	1930 lm	●	0,8
EL23N	1x11,8W	3000	1930 lm	●	0,8
EL23OB	1x11,8W	3000	1930 lm	○	0,8
EL23OG	1x11,8W	3000	1930 lm	●	0,8
EL23ON	1x11,8W	3000	1930 lm	●	0,8
EL23TB	1x11,8W	3000	1930 lm	○	0,8
EL23TG	1x11,8W	3000	1930 lm	●	0,8
EL23TN	1x11,8W	3000	1930 lm	●	0,8
EL23WB	1x11,8W	3000	1930 lm	○	0,8
EL23WG	1x11,8W	3000	1930 lm	●	0,8
EL23WN	1x11,8W	3000	1930 lm	●	0,8
EL24B	1x11,8W	4000	2050 lm	○	0,8
EL24G	1x11,8W	4000	2050 lm	●	0,8
EL24N	1x11,8W	4000	2050 lm	●	0,8
EL24OB	1x11,8W	4000	2050 lm	○	0,8
EL24OG	1x11,8W	4000	2050 lm	●	0,8
EL24ON	1x11,8W	4000	2050 lm	●	0,8
EL24TB	1x11,8W	4000	2050 lm	○	0,8
EL24TG	1x11,8W	4000	2050 lm	●	0,8
EL24TN	1x11,8W	4000	2050 lm	●	0,8
EL24WB	1x11,8W	4000	2050 lm	○	0,8
EL24WG	1x11,8W	4000	2050 lm	●	0,8
EL24WN	1x11,8W	4000	2050 lm	●	0,8
EL33B	1x17,4W	3000	2650 lm	○	0,8
EL33G	1x17,4W	3000	2650 lm	●	0,8
EL33N	1x17,4W	3000	2650 lm	●	0,8
EL33OB	1x17,4W	3000	2650 lm	○	0,8
EL33OG	1x17,4W	3000	2650 lm	●	0,8
EL33ON	1x17,4W	3000	2650 lm	●	0,8
EL33TB	1x17,4W	3000	2650 lm	○	0,8
EL33TG	1x17,4W	3000	2650 lm	●	0,8
EL33TN	1x17,4W	3000	2650 lm	●	0,8
EL33WB	1x17,4W	3000	2650 lm	○	0,8
EL33WG	1x17,4W	3000	2650 lm	●	0,8
EL33WN	1x17,4W	3000	2650 lm	●	0,8

Elit



Transparent diffuser



Opal diffuser



Wallwasher diffuser

	W	K	LUMEN	COLOUR	
EL34B	1x17,4W	4000	2850 lm	○	0,8
EL34G	1x17,4W	4000	2850 lm	●	0,8
EL34N	1x17,4W	4000	2850 lm	●	0,8
EL34OB	1x17,4W	4000	2850 lm	○	0,8
EL34OG	1x17,4W	4000	2850 lm	●	0,8
EL34ON	1x17,4W	4000	2850 lm	●	0,8
EL34TB	1x17,4W	4000	2850 lm	○	0,8
EL34TG	1x17,4W	4000	2850 lm	●	0,8
EL34TN	1x17,4W	4000	2850 lm	●	0,8
EL34WB	1x17,4W	4000	2850 lm	○	0,8
EL34WG	1x17,4W	4000	2850 lm	●	0,8
EL34WN	1x17,4W	4000	2850 lm	●	0,8
EL43B	1x25,1W	3000	3580 lm	○	0,8
EL43G	1x25,1W	3000	3580 lm	●	0,8
EL43N	1x25,1W	3000	3580 lm	●	0,8
EL43OB	1x25,1W	3000	3580 lm	○	0,8
EL43OG	1x25,1W	3000	3580 lm	●	0,8
EL43ON	1x25,1W	3000	3580 lm	●	0,8
EL43TB	1x25,1W	3000	3580 lm	○	0,8
EL43TG	1x25,1W	3000	3580 lm	●	0,8
EL43TN	1x25,1W	3000	3580 lm	●	0,8
EL43WB	1x25,1W	3000	3580 lm	○	0,8
EL43WG	1x25,1W	3000	3580 lm	●	0,8
EL43WN	1x25,1W	3000	3580 lm	●	0,8
EL44B	1x25,1W	4000	3780 lm	○	0,8
EL44G	1x25,1W	4000	3780 lm	●	0,8
EL44N	1x25,1W	4000	3780 lm	●	0,8
EL44OB	1x25,1W	4000	3780 lm	○	0,8
EL44OG	1x25,1W	4000	3780 lm	●	0,8
EL44ON	1x25,1W	4000	3780 lm	●	0,8
EL44TB	1x25,1W	4000	3780 lm	○	0,8
EL44TG	1x25,1W	4000	3780 lm	●	0,8
EL44TN	1x25,1W	4000	3780 lm	●	0,8
EL44WB	1x25,1W	4000	3780 lm	○	0,8
EL44WG	1x25,1W	4000	3780 lm	●	0,8
EL44WN	1x25,1W	4000	3780 lm	●	0,8

Ref. O Opal diffuser. IP54. UGR22
 Ref. T Transparent diffuser. IP54. UGR19
 Ref. W Wallwasher diffuser. IP20. UGR19
 Without diffuser. IP20. UGR19



NUMBER OF FITTINGS NEEDED FOR A STANDARD INSTALLATION

EL34

	200 lx	300 lx	500 lx
50 m ²	4	6	9
100 m ²	6	9	16
150 m ²	9	15	22
200 m ²	12	18	30

Height used for the calculation: 2,8 m



New

IP 20-54 With opal diffuser/
transparent

CRI >80 UGR 19 92-99°

Expectancy 60000 h. L70B10 Efficiency (%) 95,4

Photobiological safety



Minimum ceiling
installation height
155

Diameter range
Ø214-225

Ideal cut out
Ø218
Circular cut

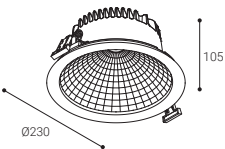

- RAL9016
- RAL7001
- RAL9005

	W	K	LUMEN	COLOUR	RA
EL63B	1x35,2W	3000	5800 lm	○	0,8
EL63G	1x35,2W	3000	5800 lm	●	0,8
EL63N	1x35,2W	3000	5800 lm	●	0,8
EL63OB	1x35,2W	3000	5800 lm	○	0,8
EL63OG	1x35,2W	3000	5800 lm	●	0,8
EL63ON	1x35,2W	3000	5800 lm	●	0,8
EL63TB	1x35,2W	3000	5800 lm	○	0,8
EL63TG	1x35,2W	3000	5800 lm	●	0,8
EL63TN	1x35,2W	3000	5800 lm	●	0,8
EL63WB	1x35,2W	3000	5800 lm	○	0,8
EL63WG	1x35,2W	3000	5800 lm	●	0,8
EL63WN	1x35,2W	3000	5800 lm	●	0,8
EL64B	1x35,2W	4000	6100 lm	○	0,8
EL64G	1x35,2W	4000	6100 lm	●	0,8
EL64N	1x35,2W	4000	6100 lm	●	0,8
EL64OB	1x35,2W	4000	6100 lm	○	0,8
EL64OG	1x35,2W	4000	6100 lm	●	0,8
EL64ON	1x35,2W	4000	6100 lm	●	0,8
EL64TB	1x35,2W	4000	6100 lm	○	0,8
EL64TG	1x35,2W	4000	6100 lm	●	0,8
EL64TN	1x35,2W	4000	6100 lm	●	0,8
EL64WB	1x35,2W	4000	6100 lm	○	0,8
EL64WG	1x35,2W	4000	6100 lm	●	0,8
EL64WN	1x35,2W	4000	6100 lm	●	0,8
EL83B	1x54,6W	3000	8020 lm	○	0,8
EL83G	1x54,6W	3000	8020 lm	●	0,8
EL83N	1x54,6W	3000	8020 lm	●	0,8
EL83OB	1x54,6W	3000	8020 lm	○	0,8
EL83OG	1x54,6W	3000	8020 lm	●	0,8
EL83ON	1x54,6W	3000	8020 lm	●	0,8
EL83TB	1x54,6W	3000	8020 lm	○	0,8
EL83TG	1x54,6W	3000	8020 lm	●	0,8
EL83TN	1x54,6W	3000	8020 lm	●	0,8
EL83WB	1x54,6W	3000	8020 lm	○	0,8
EL83WG	1x54,6W	3000	8020 lm	●	0,8
EL83WN	1x54,6W	3000	8020 lm	●	0,8
EL84B	1x54,6W	4000	8450 lm	○	0,8
EL84G	1x54,6W	4000	8450 lm	●	0,8
EL84N	1x54,6W	4000	8450 lm	●	0,8
EL84OB	1x54,6W	4000	8450 lm	○	0,8
EL84OG	1x54,6W	4000	8450 lm	●	0,8
EL84ON	1x54,6W	4000	8450 lm	●	0,8
EL84TB	1x54,6W	4000	8450 lm	○	0,8
EL84TG	1x54,6W	4000	8450 lm	●	0,8
EL84TN	1x54,6W	4000	8450 lm	●	0,8
EL84WB	1x54,6W	4000	8450 lm	○	0,8
EL84WG	1x54,6W	4000	8450 lm	●	0,8
EL84WN	1x54,6W	4000	8450 lm	●	0,8

Ref. O Opal diffuser. IP54. UGR22
 Ref. T Transparent diffuser. IP54. UGR19
 Ref. W Wallwasher diffuser. IP20. UGR19
 Without diffuser. IP20. UGR19

Elit



Compatible with **NormaLINK**

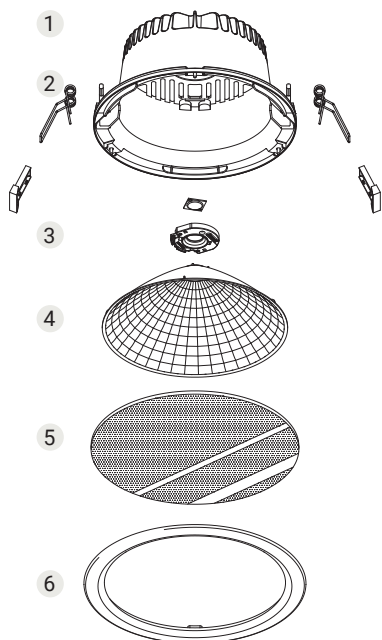

- 1 Aluminium heat sink
- 2 Fixing clamps
- 3 LED COB
- 4 Concentric rings reflector
- 5 Diffuser
- 6 Customisable aluminium ring

	W	K	LUMEN	COLOUR	
EL23DB	1x11,8W	3000	1930 lm	○	0,8
EL23DG	1x11,8W	3000	1930 lm	●	0,8
EL23DN	1x11,8W	3000	1930 lm	●	0,8
EL23DOB	1x11,8W	3000	1930 lm	○	0,8
EL23DOG	1x11,8W	3000	1930 lm	●	0,8
EL23DON	1x11,8W	3000	1930 lm	●	0,8
EL23DTB	1x11,8W	3000	1930 lm	○	0,8
EL23DTG	1x11,8W	3000	1930 lm	●	0,8
EL23DTN	1x11,8W	3000	1930 lm	●	0,8
EL24DB	1x11,8W	4000	2050 lm	○	0,8
EL24DG	1x11,8W	4000	2050 lm	●	0,8
EL24DN	1x11,8W	4000	2050 lm	●	0,8
EL24DOB	1x11,8W	4000	2050 lm	○	0,8
EL24DOG	1x11,8W	4000	2050 lm	●	0,8
EL24DON	1x11,8W	4000	2050 lm	●	0,8
EL24DTB	1x11,8W	4000	2050 lm	○	0,8
EL24DTG	1x11,8W	4000	2050 lm	●	0,8
EL24DTN	1x11,8W	4000	2050 lm	●	0,8
EL33DB	1x17,4W	3000	2650 lm	○	0,8
EL33DG	1x17,4W	3000	2650 lm	●	0,8
EL33DN	1x17,4W	3000	2650 lm	●	0,8
EL33DOB	1x17,4W	3000	2650 lm	○	0,8
EL33DOG	1x17,4W	3000	2650 lm	●	0,8
EL33DON	1x17,4W	3000	2650 lm	●	0,8
EL33DTB	1x17,4W	3000	2650 lm	○	0,8
EL33DTG	1x17,4W	3000	2650 lm	●	0,8
EL33DTN	1x17,4W	3000	2650 lm	●	0,8
EL34DB	1x17,4W	4000	2850 lm	○	0,8
EL34DG	1x17,4W	4000	2850 lm	●	0,8
EL34DN	1x17,4W	4000	2850 lm	●	0,8
EL34DOB	1x17,4W	4000	2850 lm	○	0,8
EL34DOG	1x17,4W	4000	2850 lm	●	0,8
EL34DON	1x17,4W	4000	2850 lm	●	0,8
EL34DTB	1x17,4W	4000	2850 lm	○	0,8
EL34DTG	1x17,4W	4000	2850 lm	●	0,8
EL34DTN	1x17,4W	4000	2850 lm	●	0,8
EL43DB	1x25,1W	3000	3580 lm	○	0,8
EL43DG	1x25,1W	3000	3580 lm	●	0,8
EL43DN	1x25,1W	3000	3580 lm	●	0,8
EL43DOB	1x25,1W	3000	3580 lm	○	0,8
EL43DOG	1x25,1W	3000	3580 lm	●	0,8
EL43DON	1x25,1W	3000	3580 lm	●	0,8
EL43DTB	1x25,1W	3000	3580 lm	○	0,8
EL43DTG	1x25,1W	3000	3580 lm	●	0,8
EL43DTN	1x25,1W	3000	3580 lm	●	0,8
EL44DB	1x25,1W	4000	3780 lm	○	0,8
EL44DG	1x25,1W	4000	3780 lm	●	0,8
EL44DN	1x25,1W	4000	3780 lm	●	0,8
EL44DOB	1x25,1W	4000	3780 lm	○	0,8
EL44DOG	1x25,1W	4000	3780 lm	●	0,8
EL44DON	1x25,1W	4000	3780 lm	●	0,8
EL44DTB	1x25,1W	4000	3780 lm	○	0,8
EL44DTG	1x25,1W	4000	3780 lm	●	0,8
EL44DTN	1x25,1W	4000	3780 lm	●	0,8

Ref. O Opal diffuser. IP54. UGR22
 Ref. T Transparent diffuser. IP54. UGR19
 Without diffuser. IP20. UGR19



Compatible with **NormaLINK**

IP **20-54** With opal diffuser/
transparent

CRI **>80** UGR **19** **92-99°**

Expectancy **60000 h.** Efficiency (%) **95,4**
L70B10

Photobiological safety

RG0	Risk free
RG1*	Low risk
RG2	Moderate risk
RG3	High risk

*Time under 3 h.

Minimum ceiling
installation height
155

Diameter range
Ø214-225
Ideal cut out
Ø218
Circular cut

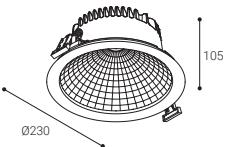

- RAL9016
- RAL7001
- RAL9005

	W	K	LUMEN	COLOUR	RA
EL63DB	1x35,2W	3000	5800 lm	○	0,8
EL63DG	1x35,2W	3000	5800 lm	●	0,8
EL63DN	1x35,2W	3000	5800 lm	●	0,8
EL63DOB	1x35,2W	3000	5800 lm	○	0,8
EL63DOG	1x35,2W	3000	5800 lm	●	0,8
EL63DON	1x35,2W	3000	5800 lm	●	0,8
EL63DTB	1x35,2W	3000	5800 lm	○	0,8
EL63DTG	1x35,2W	3000	5800 lm	●	0,8
EL63DTN	1x35,2W	3000	5800 lm	●	0,8
EL63DWB	1x35,2W	3000	5800 lm	○	0,8
EL63DWG	1x35,2W	3000	5800 lm	●	0,8
EL63DWN	1x35,2W	3000	5800 lm	●	0,8
EL64DB	1x35,2W	4000	6100 lm	○	0,8
EL64DG	1x35,2W	4000	6100 lm	●	0,8
EL64DN	1x35,2W	4000	6100 lm	●	0,8
EL64DOB	1x35,2W	4000	6100 lm	○	0,8
EL64DOG	1x35,2W	4000	6100 lm	●	0,8
EL64DON	1x35,2W	4000	6100 lm	●	0,8
EL64DTB	1x35,2W	4000	6100 lm	○	0,8
EL64DTG	1x35,2W	4000	6100 lm	●	0,8
EL64DTN	1x35,2W	4000	6100 lm	●	0,8
EL64DWB	1x35,2W	4000	6100 lm	○	0,8
EL64DWG	1x35,2W	4000	6100 lm	●	0,8
EL64DWN	1x35,2W	4000	6100 lm	●	0,8
EL83DB	1x54,6W	3000	8020 lm	○	0,8
EL83DG	1x54,6W	3000	8020 lm	●	0,8
EL83DN	1x54,6W	3000	8020 lm	●	0,8
EL83DOB	1x54,6W	3000	8020 lm	○	0,8
EL83DOG	1x54,6W	3000	8020 lm	●	0,8
EL83DON	1x54,6W	3000	8020 lm	●	0,8
EL83DTB	1x54,6W	3000	8020 lm	○	0,8
EL83DTG	1x54,6W	3000	8020 lm	●	0,8
EL83DTN	1x54,6W	3000	8020 lm	●	0,8
EL83DWB	1x54,6W	3000	8020 lm	○	0,8
EL83DWG	1x54,6W	3000	8020 lm	●	0,8
EL83DWN	1x54,6W	3000	8020 lm	●	0,8
EL84DB	1x54,6W	4000	8450 lm	○	0,8
EL84DG	1x54,6W	4000	8450 lm	●	0,8
EL84DN	1x54,6W	4000	8450 lm	●	0,8
EL84DOB	1x54,6W	4000	8450 lm	○	0,8
EL84DOG	1x54,6W	4000	8450 lm	●	0,8
EL84DON	1x54,6W	4000	8450 lm	●	0,8
EL84DTB	1x54,6W	4000	8450 lm	○	0,8
EL84DTG	1x54,6W	4000	8450 lm	●	0,8
EL84DTN	1x54,6W	4000	8450 lm	●	0,8
EL84DWB	1x54,6W	4000	8450 lm	○	0,8
EL84DWG	1x54,6W	4000	8450 lm	●	0,8
EL84DWN	1x54,6W	4000	8450 lm	●	0,8

Ref. O Opal diffuser. IP54. UGR22
 Ref. T Transparent diffuser. IP54. UGR19
 Ref. W Wallwasher diffuser. IP20. UGR19
 Without diffuser. IP20. UGR19

Elit Max

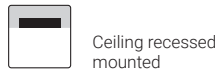

Now
up to 8450 lm



IP 20-54 With opal diffuser/transparent

CRI >80 UGR 19 95-99°

Expectancy 60000 h. L70B10 Efficiency (%) 95,4

Photobiological safety

RG0	Risk free
RG1*	1 Low risk
RG2	Moderate risk
RG3	High risk

*Time under 3 h.

Without diffuser

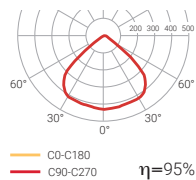

Transparent diffuser

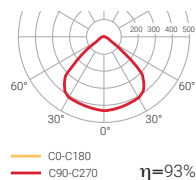

Opal diffuser

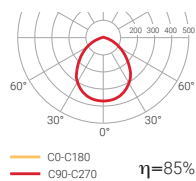

Wallwasher diffuser

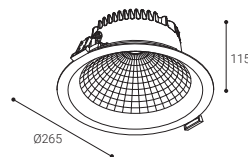
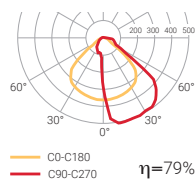

Minimum ceiling installation height 165

Diameter range Ø238-260
Ideal cut out Ø245
Circular cut

- RAL9016
- RAL7001
- RAL9005

	W	K	LUMEN	COLOUR	η
EE33B	1x17,4W	3000	2650 lm	○	0,9
EE33G	1x17,4W	3000	2650 lm	●	0,9
EE33N	1x17,4W	3000	2650 lm	●	0,9
EE330B	1x17,4W	3000	2650 lm	○	0,9
EE330G	1x17,4W	3000	2650 lm	●	0,9
EE330N	1x17,4W	3000	2650 lm	●	0,9
EE33TB	1x17,4W	3000	2650 lm	○	0,9
EE33TG	1x17,4W	3000	2650 lm	●	0,9
EE33TN	1x17,4W	3000	2650 lm	●	0,9
EE33WB	1x17,4W	3000	2650 lm	○	0,9
EE33WG	1x17,4W	3000	2650 lm	●	0,9
EE33WN	1x17,4W	3000	2650 lm	●	0,9
EE34B	1x17,4W	4000	2850 lm	○	0,9
EE34G	1x17,4W	4000	2850 lm	●	0,9
EE34N	1x17,4W	4000	2850 lm	●	0,9
EE340B	1x17,4W	4000	2850 lm	○	0,9
EE340G	1x17,4W	4000	2850 lm	●	0,9
EE340N	1x17,4W	4000	2850 lm	●	0,9
EE34TB	1x17,4W	4000	2850 lm	○	0,9
EE34TG	1x17,4W	4000	2850 lm	●	0,9
EE34TN	1x17,4W	4000	2850 lm	●	0,9
EE34WB	1x17,4W	4000	2850 lm	○	0,9
EE34WG	1x17,4W	4000	2850 lm	●	0,9
EE34WN	1x17,4W	4000	2850 lm	●	0,9
EE43B	1x25,1W	3000	3580 lm	○	0,9
EE43G	1x25,1W	3000	3580 lm	●	0,9
EE43N	1x25,1W	3000	3580 lm	●	0,9
EE430B	1x25,1W	3000	3580 lm	○	0,9
EE430G	1x25,1W	3000	3580 lm	●	0,9
EE430N	1x25,1W	3000	3580 lm	●	0,9
EE43TB	1x25,1W	3000	3580 lm	○	0,9
EE43TG	1x25,1W	3000	3580 lm	●	0,9
EE43TN	1x25,1W	3000	3580 lm	●	0,9
EE43WB	1x25,1W	3000	3580 lm	○	0,9
EE43WG	1x25,1W	3000	3580 lm	●	0,9
EE43WN	1x25,1W	3000	3580 lm	●	0,9

Ref. O Opal diffuser. IP54. UGR22
Ref. T Transparent diffuser. IP54. UGR19
Ref. W Wallwasher diffuser. IP20. UGR19
Without diffuser. IP20. UGR19

Elit Max

	W	K	LUMEN	COLOUR	 Kg
EE44B	1x25,1W	4000	3780 lm	○	0,9
EE44G	1x25,1W	4000	3780 lm	●	0,9
EE44N	1x25,1W	4000	3780 lm	●	0,9
EE44OB	1x25,1W	4000	3780 lm	○	0,9
EE44OG	1x25,1W	4000	3780 lm	●	0,9
EE44ON	1x25,1W	4000	3780 lm	●	0,9
EE44TB	1x25,1W	4000	3780 lm	○	0,9
EE44TG	1x25,1W	4000	3780 lm	●	0,9
EE44TN	1x25,1W	4000	3780 lm	●	0,9
EE44WB	1x25,1W	4000	3780 lm	○	0,9
EE44WG	1x25,1W	4000	3780 lm	●	0,9
EE44WN	1x25,1W	4000	3780 lm	●	0,9
EE63B	1x35,2W	3000	5800 lm	○	0,9
EE63G	1x35,2W	3000	5800 lm	●	0,9
EE63N	1x35,2W	3000	5800 lm	●	0,9
EE63OB	1x35,2W	3000	5800 lm	○	0,9
EE63OG	1x35,2W	3000	5800 lm	●	0,9
EE63ON	1x35,2W	3000	5800 lm	●	0,9
EE63TB	1x35,2W	3000	5800 lm	○	0,9
EE63TG	1x35,2W	3000	5800 lm	●	0,9
EE63TN	1x35,2W	3000	5800 lm	●	0,9
EE63WB	1x35,2W	3000	5800 lm	○	0,9
EE63WG	1x35,2W	3000	5800 lm	●	0,9
EE63WN	1x35,2W	3000	5800 lm	●	0,9
EE64B	1x35,2W	4000	6100 lm	○	0,9
EE64G	1x35,2W	4000	6100 lm	●	0,9
EE64N	1x35,2W	4000	6100 lm	●	0,9
EE64OB	1x35,2W	4000	6100 lm	○	0,9
EE64OG	1x35,2W	4000	6100 lm	●	0,9
EE64ON	1x35,2W	4000	6100 lm	●	0,9
EE64TB	1x35,2W	4000	6100 lm	○	0,9
EE64TG	1x35,2W	4000	6100 lm	●	0,9
EE64TN	1x35,2W	4000	6100 lm	●	0,9
EE64WB	1x35,2W	4000	6100 lm	○	0,9
EE64WG	1x35,2W	4000	6100 lm	●	0,9
EE64WN	1x35,2W	4000	6100 lm	●	0,9
EE83B	1x54,6W	3000	8020 lm	○	0,9
EE83G	1x54,6W	3000	8020 lm	●	0,9
EE83N	1x54,6W	3000	8020 lm	●	0,9
EE83OB	1x54,6W	3000	8020 lm	○	0,9
EE83OG	1x54,6W	3000	8020 lm	●	0,9
EE83ON	1x54,6W	3000	8020 lm	●	0,9
EE83TB	1x54,6W	3000	8020 lm	○	0,9
EE83TG	1x54,6W	3000	8020 lm	●	0,9
EE83TN	1x54,6W	3000	8020 lm	●	0,9
EE83WB	1x54,6W	3000	8020 lm	○	0,9
EE83WG	1x54,6W	3000	8020 lm	●	0,9
EE83WN	1x54,6W	3000	8020 lm	●	0,9
EE84B	1x54,6W	4000	8450 lm	○	0,9
EE84G	1x54,6W	4000	8450 lm	●	0,9
EE84N	1x54,6W	4000	8450 lm	●	0,9

Ref. O Opal diffuser. IP54. UGR22

Ref. T Transparent diffuser. IP54. UGR19

Ref. W Wallwasher diffuser. IP20. UGR19

Without diffuser. IP20. UGR19

Elit Max

IP **20-54** With opal diffuser/
transparent

CRI **>80** UGR **19** **95-99°**

Expectancy **60000 h.** Efficiency (%) **95,4**
L70B10

Photobiological safety

RG0	Risk free
RG1*	1 Low risk
RG2	Moderate risk
RG3	High risk

*Time under 3 h.



Minimum ceiling
installation height
165



Diameter range
Ø238-260

Ideal cut out
Ø245
Circular cut

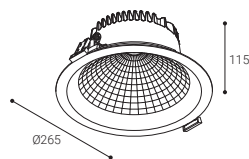

- RAL9016
- RAL7001
- RAL9005

Ref. O Opal diffuser. IP54. UGR22
Ref. T Transparent diffuser. IP54. UGR19
Ref. W Wallwasher diffuser. IP20. UGR19
Without diffuser. IP20. UGR19

	W	K	LUMEN	COLOUR	⚖️
EE840B	1x54,6W	4000	8450 lm	○	0,9
EE840G	1x54,6W	4000	8450 lm	●	0,9
EE840N	1x54,6W	4000	8450 lm	●	0,9
EE84TB	1x54,6W	4000	8450 lm	○	1,6
EE84TG	1x54,6W	4000	8450 lm	●	1,6
EE84TN	1x54,6W	4000	8450 lm	●	1,6
EE84WB	1x54,6W	4000	8450 lm	○	0,9
EE84WG	1x54,6W	4000	8450 lm	●	0,9
EE84WN	1x54,6W	4000	8450 lm	●	0,9



Compatible with **NormaLINK**

	W	K	LUMEN	COLOUR	⚖️
EE33DB	1x17,4W	3000	2650 lm	○	0,9
EE33DG	1x17,4W	3000	2650 lm	●	0,9
EE33DN	1x17,4W	3000	2650 lm	●	0,9
EE33DOB	1x17,4W	3000	2650 lm	○	0,9
EE33DOG	1x17,4W	3000	2650 lm	●	0,9
EE33DON	1x17,4W	3000	2650 lm	●	0,9
EE33DTB	1x17,4W	3000	2650 lm	○	0,9
EE33DTG	1x17,4W	3000	2650 lm	●	0,9
EE33DTN	1x17,4W	3000	2650 lm	●	0,9
EE34DB	1x17,4W	4000	2850 lm	○	0,9
EE34DG	1x17,4W	4000	2850 lm	●	0,9
EE34DN	1x17,4W	4000	2850 lm	●	0,9
EE34DOB	1x17,4W	4000	2850 lm	○	0,9
EE34DOG	1x17,4W	4000	2850 lm	●	0,9
EE34DON	1x17,4W	4000	2850 lm	●	0,9
EE34DTB	1x17,4W	4000	2850 lm	○	0,9
EE34DTG	1x17,4W	4000	2850 lm	●	0,9
EE34DTN	1x17,4W	4000	2850 lm	●	0,9
EE43DB	1x25,1W	3000	3580 lm	○	0,9
EE43DG	1x25,1W	3000	3580 lm	●	0,9
EE43DN	1x25,1W	3000	3580 lm	●	0,9
EE43DOB	1x25,1W	3000	3580 lm	○	0,9
EE43DOG	1x25,1W	3000	3580 lm	●	0,9
EE43DON	1x25,1W	3000	3580 lm	●	0,9
EE43DTB	1x25,1W	3000	3580 lm	○	0,9
EE43DTG	1x25,1W	3000	3580 lm	●	0,9
EE43DTN	1x25,1W	3000	3580 lm	●	0,9
EE44DB	1x25,1W	4000	3780 lm	○	0,9
EE44DG	1x25,1W	4000	3780 lm	●	0,9
EE44DN	1x25,1W	4000	3780 lm	●	0,9
EE44DOB	1x25,1W	4000	3780 lm	○	0,9
EE44DOG	1x25,1W	4000	3780 lm	●	0,9
EE44DON	1x25,1W	4000	3780 lm	●	0,9
EE44DTB	1x25,1W	4000	3780 lm	○	0,9
EE44DTG	1x25,1W	4000	3780 lm	●	0,9
EE44DTN	1x25,1W	4000	3780 lm	●	0,9

Elit Max



Compatible with **NormaLINK**



Transparent diffuser



Opal diffuser



Wallwasher diffuser

	W	K	LUMEN	COLOUR	
EE63DB	1x35,2W	3000	5800 lm	○	0,9
EE63DG	1x35,2W	3000	5800 lm	●	0,9
EE63DN	1x35,2W	3000	5800 lm	●	0,9
EE63DOB	1x35,2W	3000	5800 lm	○	0,9
EE63DOG	1x35,2W	3000	5800 lm	●	0,9
EE63DON	1x35,2W	3000	5800 lm	●	0,9
EE63DTB	1x35,2W	3000	5800 lm	○	0,9
EE63DTG	1x35,2W	3000	5800 lm	●	0,9
EE63DTN	1x35,2W	3000	5800 lm	●	0,9
EE63DWB	1x35,2W	3000	5800 lm	○	0,9
EE63DWG	1x35,2W	3000	5800 lm	●	0,9
EE63DWN	1x35,2W	3000	5800 lm	●	0,9
EE64DB	1x35,2W	4000	6100 lm	○	0,9
EE64DG	1x35,2W	4000	6100 lm	●	0,9
EE64DN	1x35,2W	4000	6100 lm	●	0,9
EE64DOB	1x35,2W	4000	6100 lm	○	0,9
EE64DOG	1x35,2W	4000	6100 lm	●	0,9
EE64DON	1x35,2W	4000	6100 lm	●	0,9
EE64DTB	1x35,2W	4000	6100 lm	○	0,9
EE64DTG	1x35,2W	4000	6100 lm	●	0,9
EE64DTN	1x35,2W	4000	6100 lm	●	0,9
EE64DWB	1x35,2W	4000	6100 lm	○	0,9
EE64DWG	1x35,2W	4000	6100 lm	●	0,9
EE64DWN	1x35,2W	4000	6100 lm	●	0,9
EE83DB	1x54,6W	3000	8020 lm	○	0,9
EE83DG	1x54,6W	3000	8020 lm	●	0,9
EE83DN	1x54,6W	3000	8020 lm	●	0,9
EE83DOB	1x54,6W	3000	8020 lm	○	0,9
EE83DOG	1x54,6W	3000	8020 lm	●	0,9
EE83DON	1x54,6W	3000	8020 lm	●	0,9
EE83DTB	1x54,6W	3000	8020 lm	○	0,9
EE83DTG	1x54,6W	3000	8020 lm	●	0,9
EE83DTN	1x54,6W	3000	8020 lm	●	0,9
EE83DWB	1x54,6W	3000	8020 lm	○	0,9
EE83DWG	1x54,6W	3000	8020 lm	●	0,9
EE83DWN	1x54,6W	3000	8020 lm	●	0,9
EE84DB	1x54,6W	4000	8450 lm	○	0,9
EE84DG	1x54,6W	4000	8450 lm	●	0,9
EE84DN	1x54,6W	4000	8450 lm	●	0,9
EE84DOB	1x54,6W	4000	8450 lm	○	0,9
EE84DOG	1x54,6W	4000	8450 lm	●	0,9
EE84DON	1x54,6W	4000	8450 lm	●	0,9
EE84DTB	1x54,6W	4000	8450 lm	○	1,6
EE84DTG	1x54,6W	4000	8450 lm	●	1,6
EE84DTN	1x54,6W	4000	8450 lm	●	1,6
EE84DWB	1x54,6W	4000	8450 lm	○	0,9
EE84DWG	1x54,6W	4000	8450 lm	●	0,9
EE84DWN	1x54,6W	4000	8450 lm	●	0,9

Ref. O Opal diffuser. IP54. UGR22
 Ref. T Transparent diffuser. IP54. UGR19
 Ref. W Wallwasher diffuser. IP20. UGR19
 Without diffuser. IP20. UGR19

Elit HR



Ceiling recessed mounted



LED CE RoHS 850°C

IP 20-54 With opal diffuser/transparent

CRI >80 UGR 19 92-97°

Expectancy 60000 h. L70B10 Efficiency (%) 95

Photobiological safety

RG0	Risk free
RG1*	1 Low risk
RG2	Moderate risk
RG3	High risk

*Time under 3 h.

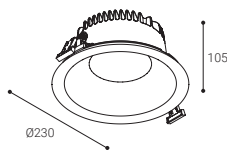

Minimum ceiling installation height 155

Diameter range Ø214-225

Ideal cut out Ø218 Circular cut

- RAL9016
- RAL7001
- RAL9005

Now up to 8450 lm

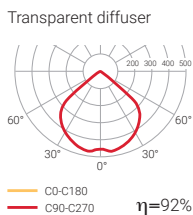
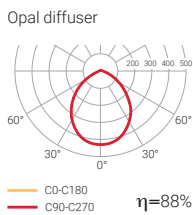
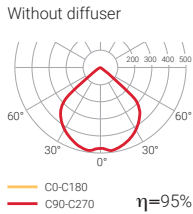

Ref. O Opal diffuser. IP54. UGR22
Ref. T Transparent diffuser. IP54. UGR19
Without diffuser. IP20. UGR19

	W	K	LUMEN	COLOUR	kg
ELI23B	1x11,8W	3000	1930 lm	○	1,0
ELI23G	1x11,8W	3000	1930 lm	●	1,0
ELI23N	1x11,8W	3000	1930 lm	●	1,0
ELI23OB	1x11,8W	3000	1930 lm	○	1,0
ELI23OG	1x11,8W	3000	1930 lm	●	1,0
ELI23ON	1x11,8W	3000	1930 lm	●	1,0
ELI23TB	1x11,8W	3000	1930 lm	○	1,0
ELI23TG	1x11,8W	3000	1930 lm	●	1,0
ELI23TN	1x11,8W	3000	1930 lm	●	1,0
ELI24B	1x11,8W	4000	2050 lm	○	1,0
ELI24G	1x11,8W	4000	2050 lm	●	1,0
ELI24N	1x11,8W	4000	2050 lm	●	1,0
ELI24OB	1x13W	4000	2050 lm	○	1,0
ELI24OG	1x11,8W	4000	2050 lm	●	1,0
ELI24ON	1x11,8W	4000	2050 lm	●	1,0
ELI24TB	1x11,8W	4000	2050 lm	○	1,0
ELI24TG	1x11,8W	4000	2050 lm	●	1,0
ELI24TN	1x11,8W	4000	2050 lm	●	1,0
ELI33B	1x17,4W	3000	2650 lm	○	1,0
ELI33G	1x17,4W	3000	2650 lm	●	1,0
ELI33N	1x17,4W	3000	2650 lm	●	1,0
ELI33OB	1x17,4W	3000	2650 lm	○	1,0
ELI33OG	1x17,4W	3000	2650 lm	●	1,0
ELI33ON	1x17,4W	3000	2650 lm	●	1,0
ELI33TB	1x17,4W	3000	2650 lm	○	1,0
ELI33TG	1x17,4W	3000	2650 lm	●	1,0
ELI33TN	1x17,4W	3000	2650 lm	●	1,0
ELI34B	1x17,4W	4000	2850 lm	○	1,0
ELI34G	1x17,4W	4000	2850 lm	●	1,0
ELI34N	1x17,4W	4000	2850 lm	●	1,0
ELI34OB	1x19,14W	4000	2850 lm	○	1,0
ELI34OG	1x17,4W	4000	2850 lm	●	1,0
ELI34ON	1x17,4W	4000	2850 lm	●	1,0
ELI34TB	1x17,4W	4000	2850 lm	○	1,0
ELI34TG	1x17,4W	4000	2850 lm	●	1,0
ELI34TN	1x17,4W	4000	2850 lm	●	1,0

Elit HR

IP **20-54** With opal diffuser/
transparent

CRI **>80** UGR **19**  **92-97°**

Expectancy **60000 h.** Efficiency (%) **95**
L70B10

Photobiological safety

RG0	Risk free
RG1*	1 Low risk
RG2	Moderate risk
RG3	High risk

*Time under 3 h.

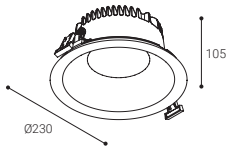

 Minimum ceiling
installation height
155

 Diameter range
Ø214-225
Ideal cut out
Ø218
Circular cut

- RAL9016
- RAL7001
- RAL9005

	W	K	LUMEN	COLOUR	
ELI43B	1x25,1W	3000	3580 lm	○	1,0
ELI43G	1x25,1W	3000	3580 lm	●	1,0
ELI43N	1x25,1W	3000	3580 lm	●	1,0
ELI43OB	1x25,1W	3000	3580 lm	○	1,0
ELI43OG	1x25,1W	3000	3580 lm	●	1,0
ELI43ON	1x25,1W	3000	3580 lm	●	1,0
ELI43TB	1x25,1W	3000	3580 lm	○	1,0
ELI43TG	1x25,1W	3000	3580 lm	●	1,0
ELI43TN	1x25,1W	3000	3580 lm	●	1,0
ELI44B	1x25,1W	4000	3780 lm	○	1,0
ELI44G	1x25,1W	4000	3780 lm	●	1,0
ELI44N	1x25,1W	4000	3780 lm	●	1,0
ELI44OB	1x25,1W	4000	3780 lm	○	1,0
ELI44OG	1x25,1W	4000	3780 lm	●	1,0
ELI44ON	1x25,1W	4000	3780 lm	●	1,0
ELI44TB	1x25,1W	4000	3780 lm	○	1,0
ELI44TG	1x25,1W	4000	3780 lm	●	1,0
ELI44TN	1x25,1W	4000	3780 lm	●	1,0
ELI63B	1x35,2W	3000	5800 lm	○	0,8
ELI63G	1x35,2W	3000	5800 lm	●	0,8
ELI63N	1x35,2W	3000	5800 lm	●	0,8
ELI63OB	1x35,2W	3000	5800 lm	○	0,8
ELI63OG	1x35,2W	3000	5800 lm	●	0,8
ELI63ON	1x35,2W	3000	5800 lm	●	0,8
ELI63TB	1x35,2W	3000	5800 lm	○	0,8
ELI63TG	1x35,2W	3000	5800 lm	●	0,8
ELI63TN	1x35,2W	3000	5800 lm	●	0,8
ELI64B	1x35,2W	4000	6100 lm	○	0,8
ELI64G	1x35,2W	4000	6100 lm	●	0,8
ELI64N	1x35,2W	4000	6100 lm	●	0,8
ELI64OB	1x35,2W	4000	6100 lm	○	0,8
ELI64OG	1x35,2W	4000	6100 lm	●	0,8
ELI64ON	1x35,2W	4000	6100 lm	●	0,8
ELI64TB	1x35,2W	4000	6100 lm	○	0,8
ELI64TG	1x35,2W	4000	6100 lm	●	0,8
ELI64TN	1x35,2W	4000	6100 lm	●	0,8
ELI83B	1x54,6W	3000	8020 lm	○	0,8
ELI83G	1x54,6W	3000	8020 lm	●	0,8
ELI83N	1x54,6W	3000	8020 lm	●	0,8
ELI83OB	1x54,6W	3000	8020 lm	○	0,8
ELI83OG	1x54,6W	3000	8020 lm	●	0,8
ELI83ON	1x54,6W	3000	8020 lm	●	0,8
ELI83TB	1x54,6W	3000	8020 lm	○	0,8
ELI83TG	1x54,6W	3000	8020 lm	●	0,8
ELI83TN	1x54,6W	3000	8020 lm	●	0,8
ELI84B	1x54,6W	4000	8450 lm	○	0,8
ELI84G	1x54,6W	4000	8450 lm	●	0,8
ELI84N	1x54,6W	4000	8450 lm	●	0,8
ELI84OB	1x54,6W	4000	8450 lm	○	0,8
ELI84OG	1x54,6W	4000	8450 lm	●	0,8
ELI84ON	1x54,6W	4000	8450 lm	●	0,8
ELI84TB	1x54,6W	4000	8450 lm	○	0,8
ELI84TG	1x54,6W	4000	8450 lm	●	0,8
ELI84TN	1x54,6W	4000	8450 lm	●	0,8

Ref. O Opal diffuser. IP54. UGR22
Ref. T Transparent diffuser. IP54. UGR19
Without diffuser. IP20. UGR19

Elit HR



Compatible with **NormaLINK**



	W	K	LUMEN	COLOUR	
ELI23DB	1x11,8W	3000	1930 lm	○	1,0
ELI23DG	1x11,8W	3000	1930 lm	●	1,0
ELI23DN	1x11,8W	3000	1930 lm	●	1,0
ELI23DOB	1x11,8W	3000	1930 lm	○	1,0
ELI23DOG	1x11,8W	3000	1930 lm	●	1,0
ELI23DON	1x11,8W	3000	1930 lm	●	1,0
ELI23DTB	1x11,8W	3000	1930 lm	○	1,0
ELI23DTG	1x11,8W	3000	1930 lm	●	1,0
ELI23DTN	1x11,8W	3000	1930 lm	●	1,0
ELI24DB	1x11,8W	4000	2050 lm	○	1,0
ELI24DG	1x11,8W	4000	2050 lm	●	1,0
ELI24DN	1x11,8W	4000	2050 lm	●	1,0
ELI24DOB	1x11,8W	4000	2050 lm	○	1,0
ELI24DOG	1x11,8W	4000	2050 lm	●	1,0
ELI24DON	1x11,8W	4000	2050 lm	●	1,0
ELI24DTB	1x11,8W	4000	2050 lm	○	1,0
ELI24DTG	1x11,8W	4000	2050 lm	●	1,0
ELI24DTN	1x11,8W	4000	2050 lm	●	1,0
ELI33DB	1x17,4W	3000	2650 lm	○	1,0
ELI33DG	1x17,4W	3000	2650 lm	●	1,0
ELI33DN	1x17,4W	3000	2650 lm	●	1,0
ELI33DOB	1x17,4W	3000	2650 lm	○	1,0
ELI33DOG	1x17,4W	3000	2650 lm	●	1,0
ELI33DON	1x17,4W	3000	2650 lm	●	1,0
ELI33DTB	1x17,4W	3000	2650 lm	○	1,0
ELI33DTG	1x17,4W	3000	2650 lm	●	1,0
ELI33DTN	1x17,4W	3000	2650 lm	●	1,0
ELI34DB	1x17,4W	4000	2850 lm	○	1,0
ELI34DG	1x17,4W	4000	2850 lm	●	1,0
ELI34DN	1x17,4W	4000	2850 lm	●	1,0
ELI34DOB	1x17,4W	4000	2850 lm	○	1,0
ELI34DOG	1x17,4W	4000	2850 lm	●	1,0
ELI34DON	1x17,4W	4000	2850 lm	●	1,0
ELI34DTB	1x17,4W	4000	2850 lm	○	1,0
ELI34DTG	1x17,4W	4000	2850 lm	●	1,0
ELI34DTN	1x17,4W	4000	2850 lm	●	1,0
ELI43DB	1x25,1W	3000	3580 lm	○	1,0
ELI43DG	1x25,1W	3000	3580 lm	●	1,0
ELI43DN	1x25,1W	3000	3580 lm	●	1,0
ELI43DOB	1x25,1W	3000	3580 lm	○	1,0
ELI43DOG	1x25,1W	3000	3580 lm	●	1,0
ELI43DON	1x25,1W	3000	3580 lm	●	1,0
ELI43DTB	1x25,1W	3000	3580 lm	○	1,0
ELI43DTG	1x25,1W	3000	3580 lm	●	1,0
ELI43DTN	1x25,1W	3000	3580 lm	●	1,0
ELI44DB	1x25,1W	4000	3780 lm	○	1,0
ELI44DG	1x25,1W	4000	3780 lm	●	1,0
ELI44DN	1x25,1W	4000	3780 lm	●	1,0
ELI44DOB	1x25,1W	4000	3780 lm	○	1,0
ELI44DOG	1x25,1W	4000	3780 lm	●	1,0
ELI44DON	1x25,1W	4000	3780 lm	●	1,0
ELI44DTB	1x25,1W	4000	3780 lm	○	1,0
ELI44DTG	1x25,1W	4000	3780 lm	●	1,0
ELI44DTN	1x25,1W	4000	3780 lm	●	1,0

Ref. O Opal diffuser. IP54. UGR22
 Ref. T Transparent diffuser. IP54. UGR19
 Without diffuser. IP20. UGR19

Elit HR



Compatible with **NormaLINK**

IP **20-54** With opal diffuser/
transparent

CRI **>80** UGR **19** **92-97°**

Expectancy **60000 h.** Efficiency (%) **95**
L70B10

Photobiological safety

RG0	Risk free
RG1*	1 Low risk
RG2	Moderate risk
RG3	High risk

*Time under 3 h.

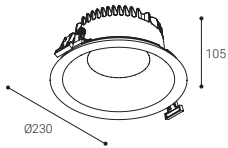

Minimum ceiling
installation height
155

Diameter range
Ø214-225

Ideal cut out
Ø218
Circular cut

- RAL9016
- RAL7001
- RAL9005

	W	K	LUMEN	COLOUR	RA
ELI63DB	1x35,2W	3000	5800 lm	○	0,8
ELI63DG	1x35,2W	3000	5800 lm	●	0,8
ELI63DN	1x35,2W	3000	5800 lm	●	0,8
ELI63DOB	1x35,2W	3000	5800 lm	○	0,8
ELI63DOG	1x35,2W	3000	5800 lm	●	0,8
ELI63DON	1x35,2W	3000	5800 lm	●	0,8
ELI63DTB	1x35,2W	3000	5800 lm	○	0,8
ELI63DTG	1x35,2W	3000	5800 lm	●	0,8
ELI63DTN	1x35,2W	3000	5800 lm	●	0,8
ELI64DB	1x35,2W	4000	6100 lm	○	0,8
ELI64DG	1x35,2W	4000	6100 lm	●	0,8
ELI64DN	1x35,2W	4000	6100 lm	●	0,8
ELI64DOB	1x35,2W	4000	6100 lm	○	0,8
ELI64DOG	1x35,2W	4000	6100 lm	●	0,8
ELI64DON	1x35,2W	4000	6100 lm	●	0,8
ELI64DTB	1x35,2W	4000	6100 lm	○	0,8
ELI64DTG	1x35,2W	4000	6100 lm	●	0,8
ELI64DTN	1x35,2W	4000	6100 lm	●	0,8
ELI83DB	1x54,6W	3000	8020 lm	○	0,8
ELI83DG	1x54,6W	3000	8020 lm	●	0,8
ELI83DN	1x54,6W	3000	8020 lm	●	0,8
ELI83DOB	1x54,6W	3000	8020 lm	○	0,8
ELI83DOG	1x54,6W	3000	8020 lm	●	0,8
ELI83DON	1x54,6W	3000	8020 lm	●	0,8
ELI83DTB	1x54,6W	3000	8020 lm	○	0,8
ELI83DTG	1x54,6W	3000	8020 lm	●	0,8
ELI83DTN	1x54,6W	3000	8020 lm	●	0,8
ELI84DB	1x54,6W	4000	8450 lm	○	0,8
ELI84DG	1x54,6W	4000	8450 lm	●	0,8
ELI84DN	1x54,6W	4000	8450 lm	●	0,8
ELI84DOB	1x54,6W	4000	8450 lm	○	0,8
ELI84DOG	1x54,6W	4000	8450 lm	●	0,8
ELI84DON	1x54,6W	4000	8450 lm	●	0,8
ELI84DTB	1x54,6W	4000	8450 lm	○	0,8
ELI84DTG	1x54,6W	4000	8450 lm	●	0,8
ELI84DTN	1x54,6W	4000	8450 lm	●	0,8

Ref. O Opal diffuser. IP54. UGR22
Ref. T Transparent diffuser. IP54. UGR19
Without diffuser. IP20. UGR19

Elit HR Mini



Ceiling recessed mounted



IP **20-54** With opal diffuser/
transparent

CRI **>80** UGR **19** **92-97°**

Expectancy **60000 h.** Efficiency (%) **95**
L70B10

Photobiological safety

RG0	Risk free
RG1*	1 Low risk
RG2	Moderate risk
RG3	High risk

*Time under 3 h.

Now up to 8450 lm

ED12/3

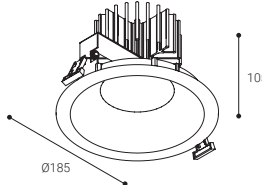

ED14

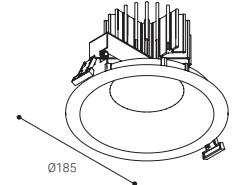

ED16/8

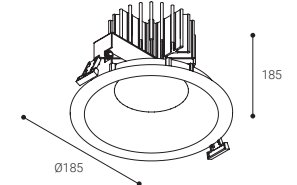

Diameter range **Ø165-180**

Ideal cut out **Ø170**
Circular cut

- RAL9016
- RAL7001
- RAL9005

Without diffuser

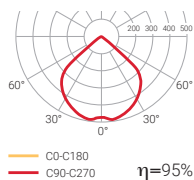

Opal diffuser

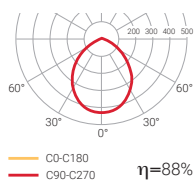

Transparent diffuser

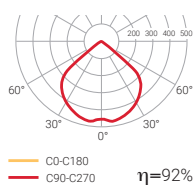

Ref. O Opal diffuser. IP54. UGR22
Ref. T Transparent diffuser. IP54. UGR19
Without diffuser. IP20. UGR19

	W	K	LUMEN	COLOUR	⚙️
ED123B	1x11,8W	3000	1930 lm	○	1,0
ED123G	1x11,8W	3000	1930 lm	●	1,0
ED123N	1x11,8W	3000	1930 lm	●	1,0
ED123OB	1x11,8W	3000	1930 lm	○	1,0
ED123OG	1x11,8W	3000	1930 lm	●	1,0
ED123ON	1x11,8W	3000	1930 lm	●	1,0
ED123TB	1x11,8W	3000	1930 lm	○	1,0
ED123TG	1x11,8W	3000	1930 lm	●	1,0
ED123TN	1x11,8W	3000	1930 lm	●	1,0
ED124B	1x11,8W	4000	2050 lm	○	1,0
ED124G	1x11,8W	4000	2050 lm	●	1,0
ED124N	1x11,8W	4000	2050 lm	●	1,0
ED124OB	1x11,8W	4000	2050 lm	○	1,0
ED124OG	1x11,8W	4000	2050 lm	●	1,0
ED124ON	1x11,8W	4000	2050 lm	●	1,0
ED124TB	1x11,8W	4000	2050 lm	○	1,0
ED124TG	1x11,8W	4000	2050 lm	●	1,0
ED124TN	1x11,8W	4000	2050 lm	●	1,0
ED133B	1x17,4W	3000	2650 lm	○	1,0
ED133G	1x17,4W	3000	2650 lm	●	1,0
ED133N	1x17,4W	3000	2650 lm	●	1,0
ED133OB	1x17,4W	3000	2650 lm	○	1,0
ED133OG	1x17,4W	3000	2650 lm	●	1,0
ED133ON	1x17,4W	3000	2650 lm	●	1,0
ED133TB	1x17,4W	3000	2650 lm	○	1,0
ED133TG	1x17,4W	3000	2650 lm	●	1,0
ED133TN	1x17,4W	3000	2650 lm	●	1,0

Elit HR Mini

IP **20-54** With opal diffuser/
transparent

CRI **>80** UGR **19** **92-97°**

Expectancy **60000 h.** Efficiency (%) **95**
L70B10

Photobiological safety



*Time under 3h.

Diameter range **Ø165-180** Ideal cut out **Ø170**
Circular cut

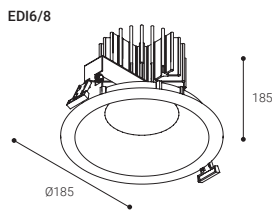
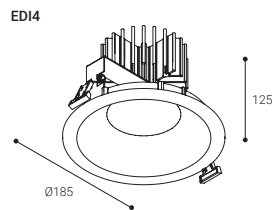
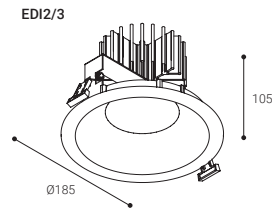

- RAL9016
- RAL7001
- RAL9005

	W	K	LUMEN	COLOUR	UGR
EDI34B	1x17,4W	4000	2850 lm	○	1,0
EDI34G	1x17,4W	4000	2850 lm	●	1,0
EDI34N	1x17,4W	4000	2850 lm	●	1,0
EDI34OB	1x17,4W	4000	2850 lm	○	1,0
EDI34OG	1x17,4W	4000	2850 lm	●	1,0
EDI34ON	1x17,4W	4000	2850 lm	●	1,0
EDI34TB	1x17,4W	4000	2850 lm	○	1,0
EDI34TG	1x17,4W	4000	2850 lm	●	1,0
EDI34TN	1x17,4W	4000	2850 lm	●	1,0
EDI43B	1x25,1W	3000	3580 lm	○	1,0
EDI43G	1x25,1W	3000	3580 lm	●	1,0
EDI43N	1x25,1W	3000	3580 lm	●	1,0
EDI43OB	1x25,1W	3000	3580 lm	○	1,0
EDI43OG	1x25,1W	3000	3580 lm	●	1,0
EDI43ON	1x25,1W	3000	3580 lm	●	1,0
EDI43TB	1x25,1W	3000	3580 lm	○	1,0
EDI43TG	1x25,1W	3000	3580 lm	●	1,0
EDI43TN	1x25,1W	3000	3580 lm	●	1,0
EDI44B	1x25,1W	4000	3780 lm	○	1,0
EDI44G	1x25,1W	4000	3780 lm	●	1,0
EDI44N	1x25,1W	4000	3780 lm	●	1,0
EDI44OB	1x25,1W	4000	3780 lm	○	1,0
EDI44OG	1x25,1W	4000	3780 lm	●	1,0
EDI44ON	1x25,1W	4000	3780 lm	●	1,0
EDI44TB	1x25,1W	4000	3780 lm	○	1,0
EDI44TG	1x25,1W	4000	3780 lm	●	1,0
EDI44TN	1x25,1W	4000	3780 lm	●	1,0
EDI63B	1x35,2W	3000	5800 lm	○	1,6
EDI63G	1x35,2W	3000	5800 lm	●	1,6
EDI63N	1x35,2W	3000	5800 lm	●	1,6
EDI63OB	1x35,2W	3000	5800 lm	○	1,6
EDI63OG	1x35,2W	3000	5800 lm	●	1,6
EDI63ON	1x35,2W	3000	5800 lm	●	1,6
EDI63TB	1x35,2W	3000	5800 lm	○	1,7
EDI63TG	1x35,2W	3000	5800 lm	●	1,6
EDI63TN	1x35,2W	3000	5800 lm	●	1,6
EDI64B	1x35,2W	4000	6100 lm	○	1,7
EDI64G	1x35,2W	4000	6100 lm	●	1,6
EDI64N	1x35,2W	4000	6100 lm	●	1,6
EDI64OB	1x35,2W	4000	6100 lm	○	1,6
EDI64OG	1x35,2W	4000	6100 lm	●	1,6
EDI64ON	1x35,2W	4000	6100 lm	●	1,6
EDI64TB	1x35,2W	4000	6100 lm	○	1,7
EDI64TG	1x35,2W	4000	6100 lm	●	1,6
EDI64TN	1x35,2W	4000	6100 lm	●	1,6

Ref. O Opal diffuser. IP54. UGR22
Ref. T Transparent diffuser. IP54. UGR19
Without diffuser. IP20. UGR19

Elit HR Mini



	W	K	LUMEN	COLOUR	
EDI83B	1x54,6W	3000	8020 lm	○	1,6
EDI83G	1x54,6W	3000	8020 lm	●	1,6
EDI83N	1x54,6W	3000	8020 lm	●	1,6
EDI83OB	1x54,6W	3000	8020 lm	○	1,6
EDI83OG	1x54,6W	3000	8020 lm	●	1,6
EDI83ON	1x54,6W	3000	8020 lm	●	1,6
EDI83TB	1x54,6W	3000	8020 lm	○	1,6
EDI83TG	1x54,6W	3000	8020 lm	●	1,6
EDI83TN	1x54,6W	3000	8020 lm	●	1,6
EDI84B	1x54,6W	4000	8450 lm	○	1,6
EDI84G	1x54,6W	4000	8450 lm	●	1,6
EDI84N	1x54,6W	4000	8450 lm	●	1,6
EDI84OB	1x54,6W	4000	8450 lm	○	1,6
EDI84OG	1x54,6W	4000	8450 lm	●	1,6
EDI84ON	1x54,6W	4000	8450 lm	●	1,6
EDI84TB	1x54,6W	4000	8450 lm	○	1,6
EDI84TG	1x54,6W	4000	8450 lm	●	1,6
EDI84TN	1x54,6W	4000	8450 lm	●	1,6



Compatible with **NormaLINK** 

	W	K	LUMEN	COLOUR	
EDI23DB	1x11,8W	3000	1930 lm	○	1,0
EDI23DG	1x11,8W	3000	1930 lm	●	1,0
EDI23DN	1x11,8W	3000	1930 lm	●	1,0
EDI23DOB	1x11,8W	3000	1930 lm	○	1,0
EDI23DOG	1x11,8W	3000	1930 lm	●	1,0
EDI23DON	1x11,8W	3000	1930 lm	●	1,0
EDI23DTB	1x11,8W	3000	1930 lm	○	1,0
EDI23DTG	1x11,8W	3000	1930 lm	●	1,0
EDI23DTN	1x11,8W	3000	1930 lm	●	1,0
EDI24DB	1x11,8W	4000	2050 lm	○	1,0
EDI24DG	1x11,8W	4000	2050 lm	●	1,0
EDI24DN	1x11,8W	4000	2050 lm	●	1,0
EDI24DOB	1x11,8W	4000	2050 lm	○	1,0
EDI24DOG	1x11,8W	4000	2050 lm	●	1,0
EDI24DON	1x11,8W	4000	2050 lm	●	1,0
EDI24DTB	1x11,8W	4000	2050 lm	○	1,0
EDI24DTG	1x11,8W	4000	2050 lm	●	1,0
EDI24DTN	1x11,8W	4000	2050 lm	●	1,0

Ref. O Opal diffuser. IP54. UGR22
 Ref. T Transparent diffuser. IP54. UGR19
 Without diffuser. IP20. UGR19

Elit HR Mini



Compatible with **NormaLINK**

IP **20-54** With opal diffuser/
transparent

CRI **>80** UGR **19** **92-97°**

Expectancy **60000 h.** Efficiency (%) **95**
L70B10

Photobiological safety

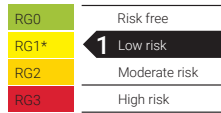

*Time under 3h.

Ideal cut out **Ø170**
Circular cut
Diameter range **Ø165-180**

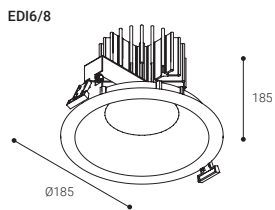
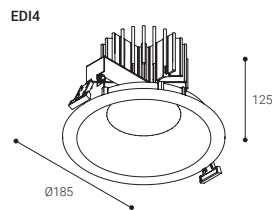
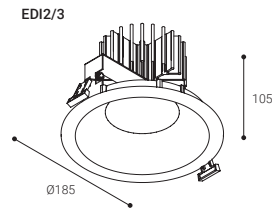

- RAL9016
- RAL7001
- RAL9005

	W	K	LUMEN	COLOUR	RA
EDI33DB	1x17,4W	3000	2650 lm	○	1,0
EDI33DG	1x17,4W	3000	2650 lm	●	1,0
EDI33DN	1x17,4W	3000	2650 lm	●	1,0
EDI33DOB	1x17,4W	3000	2650 lm	○	1,0
EDI33DOG	1x17,4W	3000	2650 lm	●	1,0
EDI33DON	1x17,4W	3000	2650 lm	●	1,0
EDI33DTB	1x17,4W	3000	2650 lm	○	1,0
EDI33DTG	1x17,4W	3000	2650 lm	●	1,0
EDI33DTN	1x17,4W	3000	2650 lm	●	1,0
EDI34DB	1x17,4W	4000	2850 lm	○	1,0
EDI34DG	1x17,4W	4000	2850 lm	●	1,0
EDI34DN	1x17,4W	4000	2850 lm	●	1,0
EDI34DOB	1x17,4W	4000	2850 lm	○	1,0
EDI34DOG	1x17,4W	4000	2850 lm	●	1,0
EDI34DON	1x17,4W	4000	2850 lm	●	1,0
EDI34DTB	1x17,4W	4000	2850 lm	○	1,0
EDI34DTG	1x17,4W	4000	2850 lm	●	1,0
EDI34DTN	1x17,4W	4000	2850 lm	●	1,0
EDI43DB	1x25,1W	3000	3580 lm	○	1,0
EDI43DG	1x25,1W	3000	3580 lm	●	1,0
EDI43DN	1x25,1W	3000	3580 lm	●	1,0
EDI43DOB	1x25,1W	3000	3580 lm	○	1,0
EDI43DOG	1x25,1W	3000	3580 lm	●	1,0
EDI43DON	1x25,1W	3000	3580 lm	●	1,0
EDI43DTB	1x25,1W	3000	3580 lm	○	1,0
EDI43DTG	1x25,1W	3000	3580 lm	●	1,0
EDI43DTN	1x25,1W	3000	3580 lm	●	1,0
EDI44DB	1x25,1W	4000	3780 lm	○	1,0
EDI44DG	1x25,1W	4000	3780 lm	●	1,0
EDI44DN	1x25,1W	4000	3780 lm	●	1,0
EDI44DOB	1x25,1W	4000	3780 lm	○	1,0
EDI44DOG	1x25,1W	4000	3780 lm	●	1,0
EDI44DON	1x25,1W	4000	3780 lm	●	1,0
EDI44DTB	1x25,1W	4000	3780 lm	○	1,0
EDI44DTG	1x25,1W	4000	3780 lm	●	1,0
EDI44DTN	1x25,1W	4000	3780 lm	●	1,0
EDI63DB	1x35,2W	3000	5800 lm	○	1,6
EDI63DG	1x35,2W	3000	5800 lm	●	1,6
EDI63DN	1x35,2W	3000	5800 lm	●	1,6
EDI63DOB	1x35,2W	3000	5800 lm	○	1,6
EDI63DOG	1x35,2W	3000	5800 lm	●	1,6
EDI63DON	1x35,2W	3000	5800 lm	●	1,6
EDI63DTB	1x35,2W	3000	5800 lm	○	1,7
EDI63DTG	1x35,2W	3000	5800 lm	●	1,6
EDI63DTN	1x35,2W	3000	5800 lm	●	1,6
EDI64DB	1x35,2W	4000	6100 lm	○	1,6
EDI64DG	1x35,2W	4000	6100 lm	●	1,6
EDI64DN	1x35,2W	4000	6100 lm	●	1,6
EDI64DOB	1x35,2W	4000	6100 lm	○	1,6
EDI64DOG	1x35,2W	4000	6100 lm	●	1,6
EDI64DON	1x35,2W	4000	6100 lm	●	1,6
EDI64DTB	1x35,2W	4000	6100 lm	○	1,7
EDI64DTG	1x35,2W	4000	6100 lm	●	1,6
EDI64DTN	1x35,2W	4000	6100 lm	●	1,6

Ref. O Opal diffuser. IP54. UGR22
Ref. T Transparent diffuser. IP54. UGR19
Without diffuser. IP20. UGR19

Elit HR Mini

Compatible with **NormaLINK**

	W	K	LUMEN	COLOUR	
EDI83DB	1x54,6W	3000	8020 lm	○	1,6
EDI83DG	1x54,6W	3000	8020 lm	●	1,6
EDI83DN	1x54,6W	3000	8020 lm	●	1,6
EDI83DOB	1x54,6W	3000	8020 lm	○	1,6
EDI83DOG	1x54,6W	3000	8020 lm	●	1,6
EDI83DON	1x54,6W	3000	8020 lm	●	1,6
EDI83DTB	1x54,6W	3000	8020 lm	○	1,6
EDI83DTG	1x54,6W	3000	8020 lm	●	1,6
EDI83DTN	1x54,6W	3000	8020 lm	●	1,6
EDI84DB	1x54,6W	4000	8450 lm	○	1,6
EDI84DG	1x54,6W	4000	8450 lm	●	1,6
EDI84DN	1x54,6W	4000	8450 lm	●	1,6
EDI84DOB	1x54,6W	4000	8450 lm	○	1,6
EDI84DOG	1x54,6W	4000	8450 lm	●	1,6
EDI84DON	1x54,6W	4000	8450 lm	●	1,6
EDI84DTB	1x54,6W	4000	8450 lm	○	1,6
EDI84DTG	1x54,6W	4000	8450 lm	●	1,6
EDI84DTN	1x54,6W	4000	8450 lm	●	1,6

Ref. O Opal diffuser. IP54. UGR22
 Ref. T Transparent diffuser. IP54. UGR19
 Without diffuser. IP20. UGR19

Elit Mini



Ceiling recessed mounted



IP **20-54** With opal diffuser/transparent

CRI **>80**

UGR **19**

90-96°

Expectancy
60000 h.
L70B10

Efficiency (%)
97,6

Photobiological safety

RG0	Risk free
RG1*	1 Low risk
RG2	Moderate risk
RG3	High risk

*Time under 3 h.

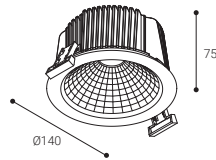

Minimum ceiling installation height
127

Diameter range
Ø128-135

Ideal cut out
Ø130
Circular cut

- RAL9016
- RAL7001
- RAL9005

Without diffuser

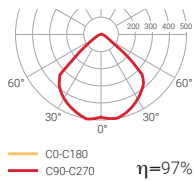

Transparent diffuser

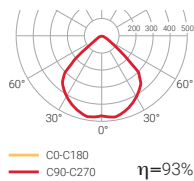

Opal diffuser

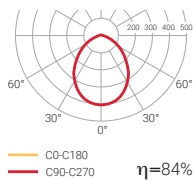

	W	K	LUMEN	COLOUR	
EM13B	1x14W	3000	1350 lm	○	0,6
EM13G	1x14W	3000	1350 lm	●	0,6
EM13N	1x14W	3000	1350 lm	●	0,6
EM130B	1x14W	3000	1350 lm	○	0,6
EM130G	1x14W	3000	1350 lm	●	0,6
EM130N	1x14W	3000	1350 lm	●	0,6
EM13TB	1x14W	3000	1350 lm	○	0,6
EM13TG	1x14W	3000	1350 lm	●	0,6
EM13TN	1x14W	3000	1350 lm	●	0,6
EM14B	1x14W	4000	1490 lm	○	0,6
EM14G	1x14W	4000	1490 lm	●	0,6
EM14N	1x14W	4000	1490 lm	●	0,6
EM140B	1x14W	4000	1490 lm	○	0,6
EM140G	1x14W	4000	1490 lm	●	0,6
EM140N	1x14W	4000	1490 lm	●	0,6
EM14TB	1x14W	4000	1490 lm	○	0,6
EM14TG	1x14W	4000	1490 lm	●	0,6
EM14TN	1x14W	4000	1490 lm	●	0,6

Ref. O Opal diffuser. IP54. UGR22
Ref. T Transparent diffuser. IP54. UGR19
Without diffuser. IP20. UGR19

Elit Mini



Compatible with **NormaLINK**



Transparent diffuser



Opal diffuser

	W	K	LUMEN	COLOUR	
EM13DB	1x14W	3000	1350 lm	○	0,6
EM13DG	1x14W	3000	1350 lm	●	0,6
EM13DN	1x14W	3000	1350 lm	●	0,6
EM13DOB	1x14W	3000	1350 lm	○	0,6
EM13DOG	1x14W	3000	1350 lm	●	0,6
EM13DON	1x14W	3000	1350 lm	●	0,6
EM13DTB	1x14W	3000	1350 lm	○	0,6
EM13DTG	1x14W	3000	1350 lm	●	0,6
EM13DTN	1x14W	3000	1350 lm	●	0,6
EM14DB	1x14W	4000	1490 lm	○	0,6
EM14DG	1x14W	4000	1490 lm	●	0,6
EM14DN	1x14W	4000	1490 lm	●	0,6
EM14DOB	1x14W	4000	1490 lm	○	0,6
EM14DOG	1x14W	4000	1490 lm	●	0,6
EM14DON	1x14W	4000	1490 lm	●	0,6
EM14DTB	1x14W	4000	1490 lm	○	0,6
EM14DTG	1x14W	4000	1490 lm	●	0,6
EM14DTN	1x14W	4000	1490 lm	●	0,6

Ref. O Opal diffuser. IP54. UGR22
 Ref. T Transparent diffuser. IP54. UGR19
 Without diffuser. IP20. UGR19

Elit Micro



Ceiling recessed mounted



IP 20-54 With opal diffuser/transparent

CRI >80 UGR 19

88-94°

Photobiological safety

RG0	Risk free
RG1*	1 Low risk
RG2	Moderate risk
RG3	High risk

*Time under 3 h.

Expectancy 60000 h. L70B10

Efficiency (%) 92,9

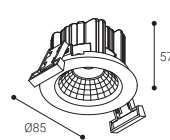

Minimum ceiling installation height 110

Diameter range Ø74-80
Ideal cut out Ø78
Circular cut

- RAL9016
- RAL7001
- RAL9005

Without diffuser

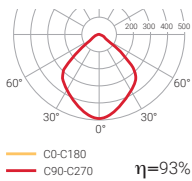

Transparent diffuser

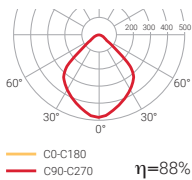

Opal diffuser

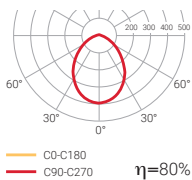

	W	K	LUMEN	COLOUR	IP
EP03B	1x6,4W	3000	760 lm	○	0,3
EP03G	1x6,4W	3000	760 lm	●	0,3
EP03N	1x6,4W	3000	760 lm	●	0,3
EP03OB	1x6,4W	3000	760 lm	○	0,3
EP03OG	1x6,4W	3000	760 lm	●	0,3
EP03ON	1x6,4W	3000	760 lm	●	0,3
EP03TB	1x6,4W	3000	760 lm	○	0,3
EP03TG	1x6,4W	3000	760 lm	●	0,3
EP03TN	1x6,4W	3000	760 lm	●	0,3
EP04B	1x6,4W	4000	885 lm	○	0,3
EP04G	1x6,4W	4000	885 lm	●	0,3
EP04N	1x6,4W	4000	885 lm	●	0,3
EP04OB	1x6,4W	4000	885 lm	○	0,3
EP04OG	1x6,4W	4000	885 lm	●	0,3
EP04ON	1x6,4W	4000	885 lm	●	0,3
EP04TB	1x6,4W	4000	885 lm	○	0,3
EP04TG	1x6,4W	4000	885 lm	●	0,3
EP04TN	1x6,4W	4000	885 lm	●	0,3

Ref. O Opal diffuser. IP54. UGR22
Ref. T Transparent diffuser. IP54. UGR19
Without diffuser. IP20. UGR19

Elit Micro



Compatible with **NormaLINK**



Transparent diffuser



Opal diffuser

	W	K	LUMEN	COLOUR	
EP03DB	1x6,4W	3000	760 lm	○	0,3
EP03DG	1x6,4W	3000	760 lm	●	0,3
EP03DN	1x6,4W	3000	760 lm	●	0,3
EP03DOB	1x6,4W	3000	760 lm	○	0,3
EP03DOG	1x6,4W	3000	760 lm	●	0,3
EP03DON	1x6,4W	3000	760 lm	●	0,3
EP03DTB	1x6,4W	3000	760 lm	○	0,3
EP03DTG	1x6,4W	3000	760 lm	●	0,3
EP03DTN	1x6,4W	3000	760 lm	●	0,3
EP04DB	1x6,4W	4000	885 lm	○	0,3
EP04DG	1x6,4W	4000	885 lm	●	0,3
EP04DN	1x6,4W	4000	885 lm	●	0,3
EP04DOB	1x6,4W	4000	885 lm	○	0,3
EP04DOG	1x6,4W	4000	885 lm	●	0,3
EP04DON	1x6,4W	4000	885 lm	●	0,3
EP04DTB	1x6,4W	4000	885 lm	○	0,3
EP04DTG	1x6,4W	4000	885 lm	●	0,3
EP04DTN	1x6,4W	4000	885 lm	●	0,3

Ref. O Opal diffuser. IP54. UGR22
 Ref. T Transparent diffuser. IP54. UGR19
 Without diffuser. IP20. UGR19