





Linnea

LINNEA is a linear luminaire built with an extruded aluminium profile for suspended installation, ceiling mounted installation or recessed installation.

It stands out thanks to its minimal design and its microprismatic diffuser which generates very homogeneous lighting with optimal visual comfort.

As a new product, the range is increased with a LINNEA MIXTO version, with direct / indirect lighting.

| | Linnea | Linnea Mixto |
|-------------------------|--|---|
| Installation | Ceiling surface mounted Ceiling suspended mounted Ceiling recessed mounted | Ceiling suspended mounted |
| Diffuser |  |  |
| Light source | LED | LED |
| Photobiological safety | 0 | 0 |
| UGR | 19 | 19 |
| CRI | >80 | >80 |
| MacAdam ellipse | 3 | 3 |
| Beam angle range | 90-101 | — |
| Power range (W) | 26,8-57 | 46,9-104,5 |
| Colour temperature (°K) | 3000 4000 | 3000 4000 |
| Light range | 3720-9000 | 6510-16500 |
| Power factor | 0,95 | 0,95 |
| Efficiency (%) | 61,1 | 64,6 |
| Expectancy | 60000 h L70B10 | 60000 h L70B10 |
| DALI Option | ✓ | ✓ |
| Continuous function 24h | ✓ | ✓ |
| IP | 30 | 30 |
| Class | I | I |



Please, ask for the technical datasheets of all the luminaires.

 Microprismatic diffuser



For other CRI values, please contact us.

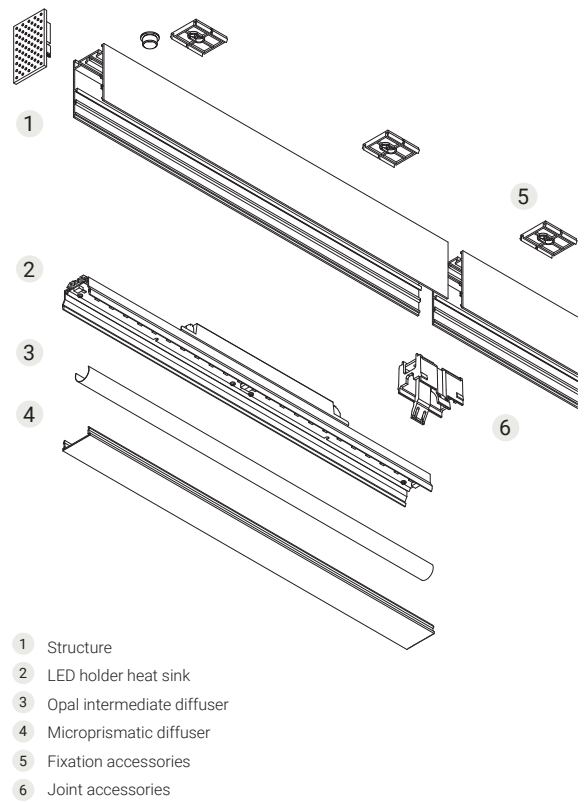
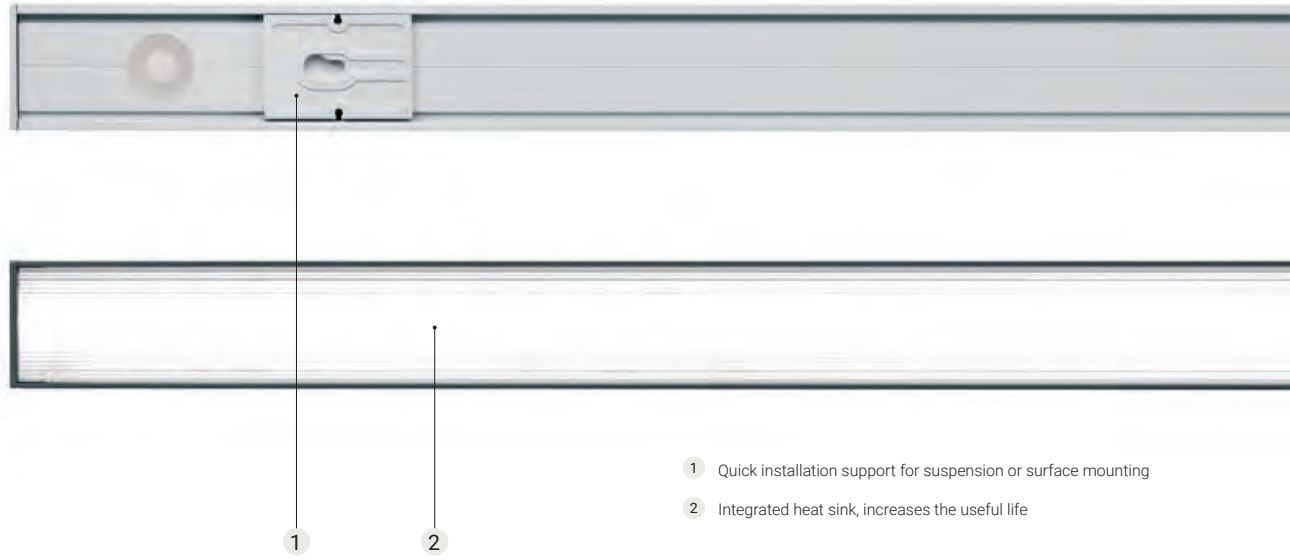

Linnea



Ceiling surface mounted



Ceiling suspended mounted

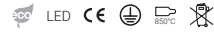
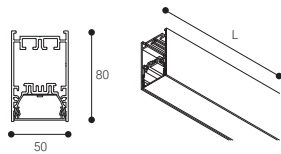

IP 30

CRI >80

UGR 19

90-101°

Photobiological safety

| | |
|------|---------------|
| RG0 | 0 Risk free |
| RG1* | Low risk |
| RG2 | Moderate risk |
| RG3 | High risk |

*Time under 3 h.

Expectancy
60000 h.
L70B10

Efficiency (%)
61,1

- RAL9016
- RAL7001

| | W | K | LUMEN | COLOUR | L(mm) | ⚠ |
|---------|---------|------|---------|--------|-------|-----|
| LI4L3OB | 1x26,8W | 3000 | 3720 lm | ○ | 1125 | 2,8 |
| LI4L3OG | 1x26,8W | 3000 | 3720 lm | ● | 1125 | 2,8 |
| LI4L4OB | 1x26,8W | 4000 | 4000 lm | ○ | 1125 | 2,8 |
| LI4L4OG | 1x26,8W | 4000 | 4000 lm | ● | 1125 | 2,8 |
| LI4H3OB | 1x38W | 3000 | 5600 lm | ○ | 1125 | 2,8 |
| LI4H3OG | 1x38W | 3000 | 5600 lm | ● | 1125 | 2,8 |
| LI4H4OB | 1x38W | 4000 | 6000 lm | ○ | 1125 | 2,8 |
| LI4H4OG | 1x38W | 4000 | 6000 lm | ● | 1125 | 2,8 |
| LI6L3OB | 1x40,2W | 3000 | 5580 lm | ○ | 1685 | 4,1 |
| LI6L3OG | 1x40,2W | 3000 | 5580 lm | ● | 1685 | 4,1 |
| LI6L4OB | 1x40,2W | 4000 | 6000 lm | ○ | 1685 | 4,1 |
| LI6L4OG | 1x40,2W | 4000 | 6000 lm | ● | 1685 | 4,1 |
| LI6H3OB | 1x57W | 3000 | 8400 lm | ○ | 1685 | 4,1 |
| LI6H3OG | 1x57W | 3000 | 8400 lm | ● | 1685 | 4,1 |
| LI6H4OB | 1x57W | 4000 | 9000 lm | ○ | 1685 | 4,1 |
| LI6H4OG | 1x57W | 4000 | 9000 lm | ● | 1685 | 4,1 |

Microprismatic diffuser

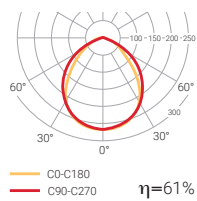

Compatible with **NormaLINK**

| | W | K | LUMEN | COLOUR | L(mm) | ⚠ |
|----------|---------|------|---------|--------|-------|-----|
| LI4L3DOB | 1x26,8W | 3000 | 3720 lm | ○ | 1125 | 2,8 |
| LI4L3DOG | 1x26,8W | 3000 | 3720 lm | ● | 1125 | 2,8 |
| LI4L4DOB | 1x26,8W | 4000 | 4000 lm | ○ | 1125 | 2,8 |
| LI4L4DOG | 1x26,8W | 4000 | 4000 lm | ● | 1125 | 2,8 |
| LI4H3DOB | 1x38W | 3000 | 5600 lm | ○ | 1125 | 2,8 |
| LI4H3DOG | 1x38W | 3000 | 5600 lm | ● | 1125 | 2,8 |
| LI4H4DOB | 1x38W | 4000 | 6000 lm | ○ | 1125 | 2,8 |
| LI4H4DOG | 1x38W | 4000 | 6000 lm | ● | 1125 | 2,8 |
| LI6L3DOB | 1x40,2W | 3000 | 5580 lm | ○ | 1685 | 4,1 |
| LI6L3DOG | 1x40,2W | 3000 | 5580 lm | ● | 1685 | 4,1 |
| LI6L4DOB | 1x40,2W | 4000 | 6000 lm | ○ | 1685 | 4,1 |
| LI6L4DOG | 1x40,2W | 4000 | 6000 lm | ● | 1685 | 4,1 |
| LI6H3DOB | 1x57W | 3000 | 8400 lm | ○ | 1685 | 4,1 |
| LI6H3DOG | 1x57W | 3000 | 8400 lm | ● | 1685 | 4,1 |
| LI6H4DOB | 1x57W | 4000 | 9000 lm | ○ | 1685 | 4,1 |
| LI6H4DOG | 1x57W | 4000 | 9000 lm | ● | 1685 | 4,1 |

It is recommended the use of suspensions every 700 mm in linear mounting of the ref. LI4L and every 1500mm in the ref. LI6L

Linnea

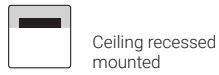

IP 30

CRI >80

UGR 19

90-101°

Expectancy
60000 h.
L70B10

Efficiency (%)
61,1

Photobiological safety

| | |
|------|---------------|
| RG0 | 0 Risk free |
| RG1* | Low risk |
| RG2 | Moderate risk |
| RG3 | High risk |

*Time under 3 h.

- RAL9016
- RAL7001

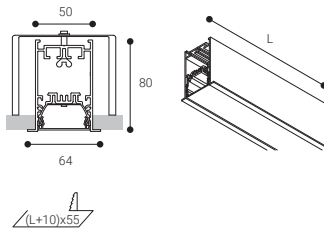

| | W | K | LUMEN | COLOUR | L(mm) | ⚖️ |
|---------|---------|------|---------|--------|-------|-----|
| LE4L3OB | 1x26,8W | 3000 | 3720 lm | ○ | 1125 | 2,9 |
| LE4L3OG | 1x26,8W | 3000 | 3720 lm | ● | 1125 | 2,9 |
| LE4L4OB | 1x26,8W | 4000 | 4000 lm | ○ | 1125 | 2,9 |
| LE4L4OG | 1x26,8W | 4000 | 4000 lm | ● | 1125 | 2,9 |
| LE4H3OB | 1x38W | 3000 | 5600 lm | ○ | 1125 | 2,9 |
| LE4H3OG | 1x38W | 3000 | 5600 lm | ● | 1125 | 2,9 |
| LE4H4OB | 1x38W | 4000 | 6000 lm | ○ | 1125 | 2,9 |
| LE4H4OG | 1x38W | 4000 | 6000 lm | ● | 1125 | 2,9 |
| LE6L3OB | 1x40,2W | 3000 | 5580 lm | ○ | 1685 | 4,4 |
| LE6L3OG | 1x40,2W | 3000 | 5580 lm | ● | 1685 | 4,4 |
| LE6L4OB | 1x40,2W | 4000 | 6000 lm | ○ | 1685 | 4,4 |
| LE6L4OG | 1x40,2W | 4000 | 6000 lm | ● | 1685 | 4,4 |
| LE6H3OB | 1x57W | 3000 | 8400 lm | ○ | 1685 | 4,4 |
| LE6H3OG | 1x57W | 3000 | 8400 lm | ● | 1685 | 4,4 |
| LE6H4OB | 1x57W | 4000 | 9000 lm | ○ | 1685 | 4,4 |
| LE6H4OG | 1x57W | 4000 | 9000 lm | ● | 1685 | 4,4 |

Microprismatic diffuser

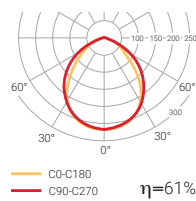

Compatible with **NormaLINK**

| | W | K | LUMEN | COLOUR | L(mm) | ⚖️ |
|----------|---------|------|---------|--------|-------|-----|
| LE4L3DOB | 1x26,8W | 3000 | 3720 lm | ○ | 1125 | 2,9 |
| LE4L3DOG | 1x26,8W | 3000 | 3720 lm | ● | 1125 | 2,9 |
| LE4L4DOB | 1x26,8W | 4000 | 4000 lm | ○ | 1125 | 2,9 |
| LE4L4DOG | 1x26,8W | 4000 | 4000 lm | ● | 1125 | 2,9 |
| LE4H3DOB | 1x38W | 3000 | 5600 lm | ○ | 1125 | 2,9 |
| LE4H3DOG | 1x38W | 3000 | 5600 lm | ● | 1125 | 2,9 |
| LE4H4DOB | 1x38W | 4000 | 6000 lm | ○ | 1125 | 2,9 |
| LE4H4DOG | 1x38W | 4000 | 6000 lm | ● | 1125 | 2,9 |
| LE6L3DOB | 1x40,2W | 3000 | 5580 lm | ○ | 1685 | 4,4 |
| LE6L3DOG | 1x40,2W | 3000 | 5580 lm | ● | 1685 | 4,4 |
| LE6L4DOB | 1x40,2W | 4000 | 6000 lm | ○ | 1685 | 4,4 |
| LE6L4DOG | 1x40,2W | 4000 | 6000 lm | ● | 1685 | 4,4 |
| LE6H3DOB | 1x57W | 3000 | 8400 lm | ○ | 1685 | 4,4 |
| LE6H3DOG | 1x57W | 3000 | 8400 lm | ● | 1685 | 4,4 |
| LE6H4DOB | 1x57W | 4000 | 9000 lm | ○ | 1685 | 4,4 |
| LE6H4DOG | 1x57W | 4000 | 9000 lm | ● | 1685 | 4,4 |

Linnea Mixto



Ceiling
suspended
mounted

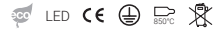

IP
30

CRI
>80

UGR
19

Expectancy
60000 h.
L70B10

Efficiency (%)
64,6

Photobiological safety

| | |
|------|--------------------|
| RG0 | 0 Risk free |
| RG1* | Low risk |
| RG2 | Moderate risk |
| RG3 | High risk |

*Time under 3 h.

○ RAL9016
● RAL7001

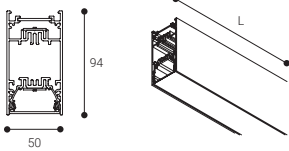

Indirect lighting

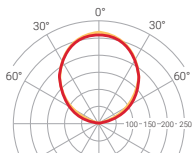

— C0-C180
— C90-C270 $\eta=68\%$

Direct lighting

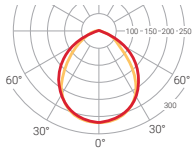

— C0-C180
— C90-C270 $\eta=61\%$

| | W | K | LUMEN | COLOUR | L(mm) | |
|---------|----------|------|----------|--------|-------|-----|
| LM4L3OB | 1x46,9W | 3000 | 6510 lm | ○ | 1125 | 3,3 |
| LM4L3OG | 1x46,9W | 3000 | 6510 lm | ● | 1125 | 3,3 |
| LM4L4OB | 1x46,9W | 4000 | 7000 lm | ○ | 1125 | 3,3 |
| LM4L4OG | 1x46,9W | 4000 | 7000 lm | ● | 1125 | 3,3 |
| LM4H3OB | 1x66,5W | 3000 | 9800 lm | ○ | 1125 | 3,3 |
| LM4H3OG | 1x66,5W | 3000 | 9800 lm | ● | 1125 | 3,3 |
| LM4H4OB | 1x66,5W | 4000 | 10500 lm | ○ | 1125 | 3,3 |
| LM4H4OG | 1x66,5W | 4000 | 10500 lm | ● | 1125 | 3,3 |
| LM6L3OB | 1x73,7W | 3000 | 10230 lm | ○ | 1685 | 4,9 |
| LM6L3OG | 1x73,7W | 3000 | 10230 lm | ● | 1685 | 4,9 |
| LM6L4OB | 1x73,7W | 4000 | 11000 lm | ○ | 1685 | 4,9 |
| LM6L4OG | 1x73,7W | 4000 | 11000 lm | ● | 1685 | 4,9 |
| LM6H3OB | 1x104,5W | 3000 | 15400 lm | ○ | 1685 | 4,9 |
| LM6H3OG | 1x104,5W | 3000 | 15400 lm | ● | 1685 | 4,9 |
| LM6H4OB | 1x104,5W | 4000 | 16500 lm | ○ | 1685 | 4,9 |
| LM6H4OG | 1x104,5W | 4000 | 16500 lm | ● | 1685 | 4,9 |



Compatible with **NormaLINK**

| | W | K | LUMEN | COLOUR | L(mm) | |
|----------|----------|------|----------|--------|-------|-----|
| LM4L3DOB | 1x46,9W | 3000 | 6510 lm | ○ | 1125 | 3,3 |
| LM4L3DOG | 1x46,9W | 3000 | 6510 lm | ● | 1125 | 3,3 |
| LM4L4DOB | 1x46,9W | 4000 | 7000 lm | ○ | 1125 | 3,3 |
| LM4L4DOG | 1x46,9W | 4000 | 7000 lm | ● | 1125 | 3,3 |
| LM4H3DOB | 1x66,5W | 3000 | 9800 lm | ○ | 1125 | 3,3 |
| LM4H3DOG | 1x66,5W | 3000 | 9800 lm | ● | 1125 | 3,3 |
| LM4H4DOB | 1x66,5W | 4000 | 10500 lm | ○ | 1125 | 3,3 |
| LM4H4DOG | 1x66,5W | 4000 | 10500 lm | ● | 1125 | 3,3 |
| LM6L3DOB | 1x73,7W | 3000 | 10230 lm | ○ | 1685 | 4,9 |
| LM6L3DOG | 1x73,7W | 3000 | 10230 lm | ● | 1685 | 4,9 |
| LM6L4DOB | 1x73,7W | 4000 | 11000 lm | ○ | 1685 | 4,9 |
| LM6L4DOG | 1x73,7W | 4000 | 11000 lm | ● | 1685 | 4,9 |
| LM6H3DOB | 1x104,5W | 3000 | 15400 lm | ○ | 1685 | 4,9 |
| LM6H3DOG | 1x104,5W | 3000 | 15400 lm | ● | 1685 | 4,9 |
| LM6H4DOB | 1x104,5W | 4000 | 16500 lm | ○ | 1685 | 4,9 |
| LM6H4DOG | 1x104,5W | 4000 | 16500 lm | ● | 1685 | 4,9 |

Linnea and Linnea Mixto

ACCESSORIES

Suspension accessory

| | L (m) |
|---------------|-------|
| 1029L2 | 2 |
| 1029L4 | 4 |

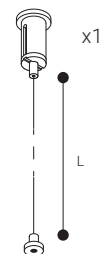

Connection box and power supply cable

| | POWER SUPPLY CABLE LENGHT | COLOUR |
|---|---------------------------|--------|
| ETC1029B | 2 | ○ |
| ETC1029G | 2 | ● |
| ETC10294MB | 4 | ○ |
| ETC10294MG | 4 | ● |
|  ETC10295PB | 2 | ○ |
| ETC10295PG | 2 | ● |
| ETC10295P4MB | 4 | ○ |
| ETC10295P4MG | 4 | ● |

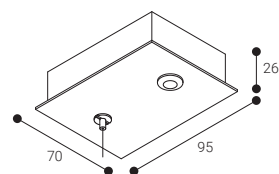

Joining accessory

| | COLOUR |
|--|--------|
| LI014 | ○ |
|  LI0145P | ○ |

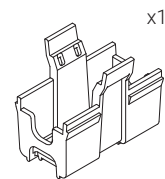

End cover Linnea

| | COLOUR |
|---------------|--------|
| LI015B | ○ |
| LI015G | ● |
| LI016B | ○ |
| LI016G | ● |

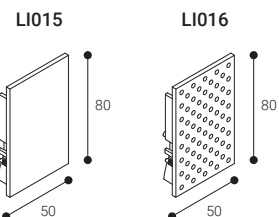

End cover Linnea Mixto

| | COLOUR |
|---------------|--------|
| LM015B | ○ |
| LM015G | ● |
| LM016B | ○ |
| LM016G | ● |

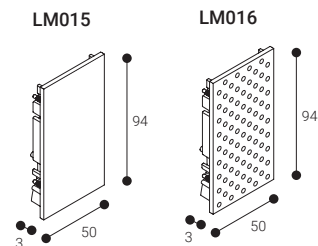

End cover recessed model

| | COLOUR |
|---------------|--------|
| LE016B | ○ |
| LE016G | ● |

