

Nassel



Premio IDEPA
para o melhor projeto inovador

O NASSEL é um modelo inovador de luminária LED especialmente indicado para tetos modulares. Transmite uma luz direta e confortável, graças à combinação de dois difusores (um microprismático e outro opalizado) e um refletor em plástico técnico de alta reflexão.

A NASSEL S é a versão deste painel para instalação aplicada no teto.



- 1 Estrutura leveira, peso reduzido
- 2 Placa Led intermutável, padrão Zhaga
- 3 Difusor Microprismático, otimiza o fluxo luminoso (UGR<19)

1 2 3

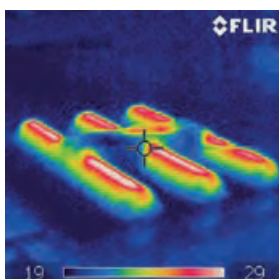

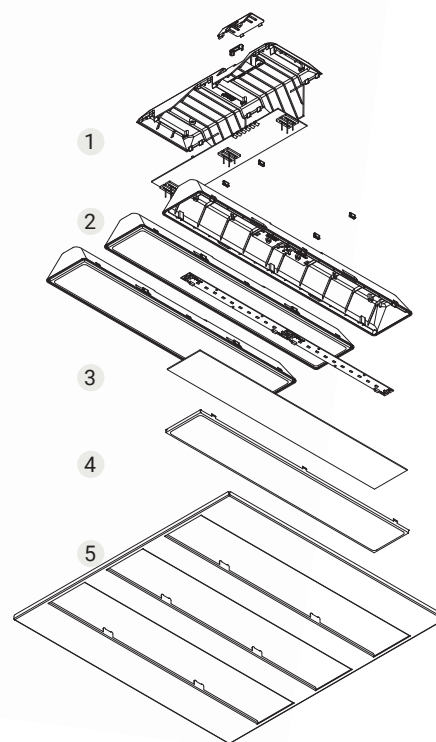

- 1 Terminal de ligação
- 2 Corpo dissipador
- 3 Difusor intermédio
- 4 Difusor Microprismático
- 5 Estrutura

	Nassel	Nassel S
Instalação	Encastrado no teto	Aplicado no teto Suspensão no teto
Difusor	☒	☒
Fonte de luz	LED	LED
Segurança fotobiológica	0	0
UGR	16	16
CRI	>80	>80
Elipses de Macadam	3	3
Gama ângulos de abertura	73	73
Gama potência (W)	36-48	24-48
Temperatura de cor (°K)	3000 4000	3000 4000
Gama de luz	3400-7400	3400-7400
Fator de potência	0,95	0,95
Rendimento (%)	80,3	80,3
Expectativa	60000 h L70B10	60000 h L70B10
Opção DALI	✓	✓
Funcionamento contínuo 24h	✓	✓
IP	20-44	30
Classe	II	II
Abertura ideal (mm)	600x600 1200x300 1200x600	

☒ Difusor microprismático



Outros valores CRI sob consulta



Solicite sempre as características técnicas de todos os produtos de iluminação.

Nassel



Encastrado no teto



IP
20-44

CRI
>80

UGR
16

73°

Expectativa
60000 h.
L70B10

Rendimento (%)
80,3

Segurança fotobiológica

RG0	0 Isento de risco
RG1*	Risco reduzido
RG2	Risco moderado
RG3	Risco elevado

*Tempo inferior a 3 h.

○ RAL9016

Instalação sobre tetos modulares

NS2

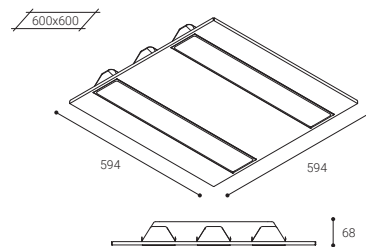

NS3

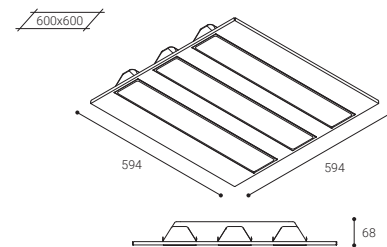

NS4

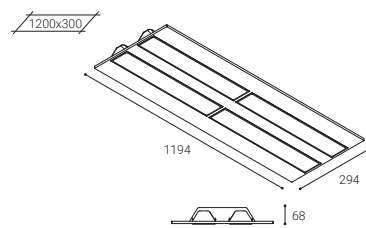

NS5

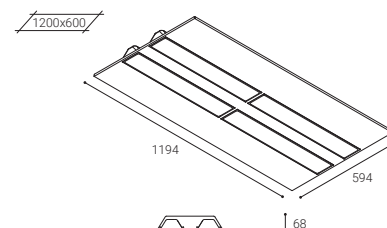

Difusor microprismático

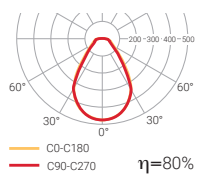

	W	K	LÚMEN	COR	
NS23B	1x24W	3000	3400 lm	○	2,9
NS24B	1x24W	4000	3700 lm	○	2,9
NS33B	1x36W	3000	5100 lm	○	2,9
NS34B	1x36W	4000	5550 lm	○	2,9
NS43B	1x48W	3000	6800 lm	○	2,9
NS44B	1x48W	4000	7400 lm	○	2,9
NS53B	1x48W	3000	6800 lm	○	7,0
NS54B	1x48W	4000	7400 lm	○	7,0



Compatível com **NormaLINK**

	W	K	LÚMEN	COR	
NS23DB	1x24W	3000	3400 lm	○	2,9
NS24DB	1x24W	4000	3700 lm	○	2,9
NS33DB	1x36W	3000	5100 lm	○	2,9
NS34DB	1x36W	4000	5550 lm	○	2,9
NS43DB	1x48W	3000	6800 lm	○	2,9
NS44DB	1x48W	4000	7400 lm	○	2,9
NS53DB	1x48W	3000	6800 lm	○	7,0
NS54DB	1x48W	4000	7400 lm	○	7,0

POSSIBILIDADE DE EXECUÇÕES ESPECIAIS

Nassel Gesso

NÚMERO DE EQUIPAMENTOS PARA UMA INSTALAÇÃO TIPO

NS34B

	200 lx	300 lx	500 lx
50 m ²	3	4	6
100 m ²	4	8	10
150 m ²	6	10	15
200 m ²	6	12	20

Se ha estimado una altura de 2,8 m para el cálculo.

! Instalação sobre tetos de gesso

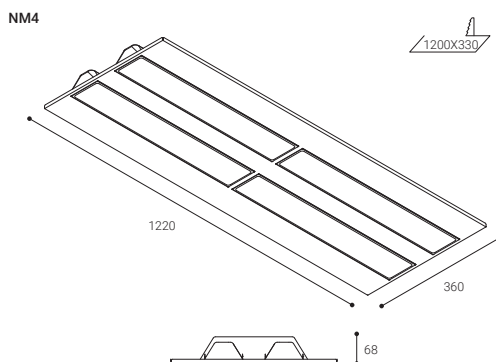
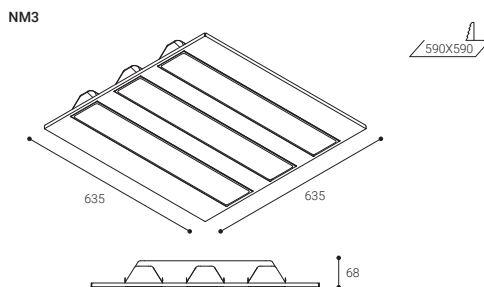

○ RAL9016

	W	K	LÚMEN	COR	
NM33B	1x36W	3000	5100 lm	○	2,9
NM34B	1x36W	4000	5550 lm	○	2,9
NM43B	1x48W	3000	6800 lm	○	2,9
NM44B	1x48W	4000	7400 lm	○	2,9



Compatível com **NormaLINK**

	W	K	LÚMEN	COR	
NM33DB	1x36W	3000	5100 lm	○	2,9
NM34DB	1x36W	4000	5550 lm	○	2,9
NM43DB	1x48W	3000	6800 lm	○	2,9
NM44DB	1x48W	4000	7400 lm	○	2,9

Nassel S



IP
30

CRI
>80

UGR
16

73°

Expectativa
60000 h.
L70B10

Rendimento (%)
80,3

Segurança fotobiológica

RG0	0 Isento de risco
RG1*	Risco reduzido
RG2	Risco moderado
RG3	Risco elevado

*Tempo inferior a 3 h.

NA2

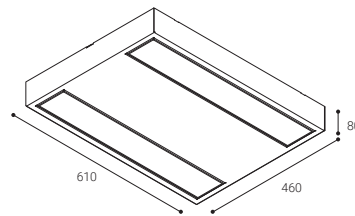

NA3

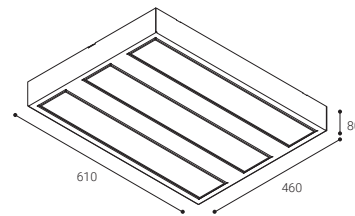

NA4

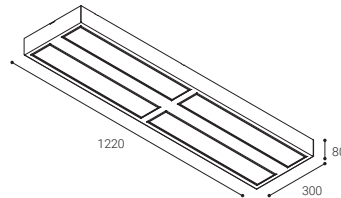

○ RAL9016

Difusor microprismático

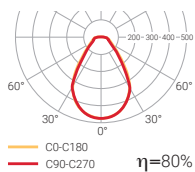

	W	K	LÚMEN	COR	
NA23B	1x24W	3000	3400 lm	○	4,8
NA24B	1x24W	4000	3700 lm	○	4,8
NA33B	1x36W	3000	5100 lm	○	4,8
NA34B	1x36W	4000	5550 lm	○	4,8
NA43B	1x48W	3000	6800 lm	○	4,8
NA44B	1x48W	4000	7400 lm	○	4,8



Compatível com **NormaLINK**

	W	K	LÚMEN	COR	
NA23DB	1x24W	3000	3400 lm	○	4,8
NA24DB	1x24W	4000	3700 lm	○	4,8
NA33DB	1x36W	3000	5100 lm	○	4,8
NA34DB	1x36W	4000	5550 lm	○	4,8
NA43DB	1x48W	3000	6800 lm	○	4,8
NA44DB	1x48W	4000	7400 lm	○	4,8

Nassel S



Suspensão no teto



LED CE RoHS

IP 20

CRI >80

UGR 16

73°

Expectativa
60000 h.
L70B10

Rendimento (%)
80,3

Segurança fotobiológica

RG0	0 Isento de risco
RG1*	Risco reduzido
RG2	Risco moderado
RG3	Risco elevado

*Tempo inferior a 3 h.

NAS2

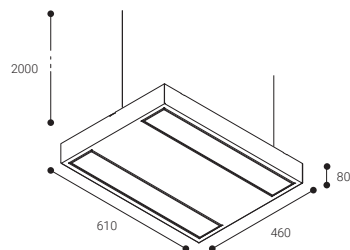

NAS3

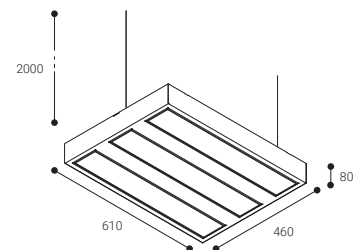

NAS4

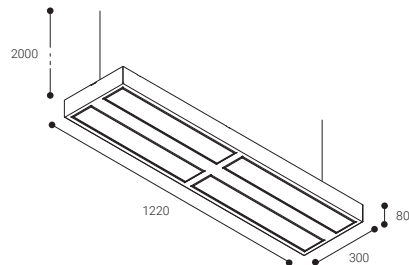

○ RAL9016

Difusor microprismático

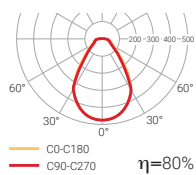

	W	K	LÚMEN	COR	
NAS23B	1x24W	3000	3400 lm	○	4,8
NAS24B	1x24W	4000	3700 lm	○	4,8
NAS33B	1x36W	3000	5100 lm	○	4,8
NAS34B	1x36W	4000	5550 lm	○	4,8
NAS43B	1x48W	3000	6800 lm	○	4,8
NAS44B	1x48W	4000	7400 lm	○	4,8



Compatível com **NormaLINK**

	W	K	LÚMEN	COR	
NAS23DB	1x24W	3000	3400 lm	○	4,8
NAS24DB	1x24W	4000	3700 lm	○	4,8
NAS33DB	1x36W	3000	5100 lm	○	4,8
NAS34DB	1x36W	4000	5550 lm	○	4,8
NAS43DB	1x48W	3000	6800 lm	○	4,8
NAS44DB	1x48W	4000	7400 lm	○	4,8

POSSIBILIDADE DE EXECUÇÕES ESPECIAIS